

Vacuum Pumps

Instrumentation

Fittings and Valves



LEYBOLD VACUUM

GA 09.504 / 5.02

COMBIVAC CM 31

Cat. No.
157 89, 896 89, 897 89

Operating Instructions

LEYBOLD-Service

If an appliance is returned to LEYBOLD, indicate whether the appliance is free of substances damaging to health or whether it is contaminated. If it is contaminated also indicate the nature of hazard. LEYBOLD must return any appliance without a declaration of contamination to the sender's address.

General Note

The right of alterations in the design and the technical data is reserved. The illustrations are not binding.

Contents

	Page		Page
1	Description		
1.1	General	2.3.5	Keys TM 1, TM 2 and PM
1.1.1	Purpose	2.3.6	Key HV
1.2	Technical data	2.3.7	Key Decrement
1.2.1	General data	2.3.8	Key Increment
1.2.2	TM measurement channels	2.3.9	Key PARA
1.2.3	PM measurement channel	2.3.9.1	Checking and setting up of the equipment parameters
1.2.4	Relay outputs	2.3.9.2	Locking of parameter settings
1.2.5	Chart recorder outputs	2.4	Supply and socket connections on the rear
1.2.6	AC power requirements	2.4.1	AC power supply
1.2.7	High voltage control input (only for PENNINGVAC)	2.4.2	Connection of the THERMOVAC gauge
1.2.8	Mechanical data	2.4.3	Connection of the PENNINGVAC gauge
1.2.9	Ambient conditions	2.4.4	Screw terminal outputs for the THERMOVAC channels
1.2.10	RS 232 C interface	2.4.5	Screw terminal outputs for the PENNINGVAC channel
1.3	Technical description	2.4.6	RS 232 C interface
1.3.1	COMBIVAC CM 31	2.5	Installing the instrument
1.3.2	THERMOVAC method of measurement (Pirani)	2.5.1	Installation
1.3.3	PENNINGVAC method of measurement (cold cathode)	2.5.2	Rack installation
1.3.4	RS 232 C interface	2.5.3	Panel installation
1.4	Equipment	2.5.4	Using the CM 31 as a table-top instrument
1.4.1	Supplied equipment	2.6	Checking the equipment functions
1.4.2	Accessories	2.6.1	The THERMOVAC channels
2	Operation	2.6.2	The PENNINGVAC channel
2.1	Start-up	2.7	Alignment of the THERMOVAC gauge heads
2.2	Electrical connection	2.8	Switching off
2.2.1	Changing the line voltage setting and exchanging the fuses	2.9	Status messages
2.3	Controls and their functions	2.10	Chart recorder output tables
2.3.1	Bar graph display	2.10.1	Chart recorder output tables for TM measurement channels
2.3.2	Digital display	2.10.2	Chart recorder output tables for PM measurement channel
2.3.3	Measurement units		
2.3.4	Status display area		

	Page		Page
3	RS 232 C interface	3.6	Output of error messages
3.1	Description	3.6.1	Interface errors (ERI)
3.2	Interface parameters	3.7	Program examples for setting the parameters
3.2.1	Baud rate	3.8	Examples for the cable link between the interface and an IBM [®] -PC
3.2.2	Data format	4	Maintenance
3.2.3	End and acknowledgement character for remote operation	4.1	Service at LEYBOLD's
3.2.4	Output rate and end character for printer output	5	Brief operating instructions
3.3	Initial operation		
3.3.1	Remote control operation		
3.3.1.1	Cable link		
3.3.1.2	Baud rate and data format		
3.3.1.3	End character		
3.3.1.4	Acknowledgement character		
3.3.1.5	Reset character		
3.3.2	Printer operation		
3.3.2.1	Output of measurement data to a printer		
3.3.2.2	RS 232 C baud rate and data format for printer output		
3.3.2.3	Output rate for printer output		
3.3.2.4	End character		
3.4	Data output and data formats		
3.4.1	Measurement data output		
3.4.1.1	Remote control operation		
3.4.1.2	Printer output		
3.4.2	Parameter output and response time		
3.5	Interface commands and data input for A-series instruments with RS 232 C interface		
3.5.1	Formation of measurement data and readout commands		
3.5.2	Trigger adjustment commands		
3.5.3	Operating parameters		

1 Description

1.1 General



The COMBIVAC CM 31 is supplied ready for use. However, we strongly recommend reading these Operating Instructions so that optimum operating conditions can be set up right from the start.

These Operating Instructions contain important information on the functions, installation, start-up, operation and troubleshooting of the CM 31.

Important remarks concerning operational safety and protection are emphasized as follows.

Warning



Indicates procedures that must be strictly observed to prevent hazards to people.

Caution

Indicates procedures that must strictly be observed to prevent damage to, or destruction of, the CM 31 and to attain specified performance levels.

Note

Indicates special technical requirements that the user must comply with.

The references to diagrams, e.g. (2/5), consist of the Fig. No. and the Item No. in that order.

Unpack the CM 31 immediately after delivery, even if it is to be installed at a later date.

Examine the shipping container for any external damage. Completely remove the packaging materials.

Note

Retain the packaging materials in the event of complaints about damage.

Check that the CM 31 is complete (see Section 1.4).

Carefully examine the CM 31 visually.

If any damage is discovered, report it immediately to the forwarding agent and insurer. If the damaged part has to be replaced, please contact Leybold.

1.1.1 Purpose

The COMBIVAC CM 31 is a universal vacuum gauge which combines two principles of measurement - Pirani (Thermovac) and cold cathode (Penningvac) - for the measurement and control of vacuum pressures within the entire range between $1 \cdot 10^{-9}$ mbar/Torr and atmospheric pressure.

One PENNINGVAC sensor (PR 32, PR 25, PR 35 or PR 36) and max. two THERMOVAC sensors (TR 201, TR 205, TR 206 or also TR 211 and TR 216) may be connected.

The built-in RS 232 C interface permits computer controlled operation as well as the exchange of measurement data between the COMBIVAC CM 31 and a computer.

Please refer to the technical data of this instrument to determine whether or not this instrument suits your application.

1.2 Technical data

1.2.1 General data

Measurement range	1·10 ⁻⁹ mbar to 1·10 ⁺³ mbar 1·10 ⁻⁹ Torr to 760 Torr
THERMOVAC channels	2
PENNINGVAC channel	1
Measurement units	mbar, Torr, Pa, Micron (selectable)
Types of gas	Air / N ₂ , Ar (selectable)
Display	digital 7 segment LCD analogue LCD bar graph
Resolution	see tables 3 and 4 or tables 7 and 8 in Section 2.10.1 or 2.10.2.

1.2.2 TM measurement channels

Measurement range	1·10 ⁻³ mbar to 1000 mbar 1·10 ⁻³ Torr to 760 Torr
Measurement uncertainty in the range	10 ⁻³ to 10 ⁻² mbar / Torr: 20 % of the meas. value 10 ⁻² to 10 ⁺² mbar / Torr: 15 % of the meas. value
Sensors	TR 201; DN 10 KF TR 205; DN 16 CF and TR 206; DN 10 KF TR 211; DN 16 KF and TR 216; DN 16 KF
Length of gauge head cable	up to 100 m
Cable length alignment	automatically for TR 211 and TR 216
For TR 201, TR 205 and TR 206	Enter cable length in the parameter mode (see Parameter-Page 9)

Trigger relays reaction time 30 ms approx.
for a pressure change exceeding
1 measurement decade

Trigger relays thresholds
2 per measurement channel; changeover contact

Modes level / interval

Ready indicator electrically
1 per measurement channel
floating n.o. contact
1 contact closed in ready mode

Error display FAIL optically, 1 per meas. channel

1.2.3 PM measurement channel

Measurement range
 $1 \cdot 10^{-9}$ mbar/Torr to $1 \cdot 10^{-2}$ mbar/Torr

Measurement uncertainty in the range
 $1 \cdot 10^{-8}$ mbar/Torr to $1 \cdot 10^{-4}$ mbar/Torr
 ± 30 % of the meas. value

Sensors PR 25; DN 25 KF
PR 35; DN 40 KF
PR 36; DN 40 CF
PR 31 and 32 (limited measurement range)

Length of gauge head cable up to 100 m for the
pressure range $1 \cdot 10^{-8}$ to $1 \cdot 10^{-2}$ mbar / Torr

Trigger relays reaction time 40 ms approx.
for a pressure change exceeding
1 measurement decade

Triggers thresholds 2; changeover contact

Modes single / interval

Ready indicator electrically floating n.o. contact
1 contact closed in ready mode

Error display FAIL optically

1.2.4 Relay outputs

Two variable thresholds per channel with one relay
changeover contact each and one ready indicating cir-
cuit with n.o. contact.

Max. switching voltage 250 V AC / 60 V DC

Max. switching capacity 5 A (AC, resistive load)
0.7 A (DC)

Contact life 60,000 cycles

Setting range of the variable thresholds
PM channel $1 \cdot 10^{-8}$ to $1 \cdot 10^{-2}$ mbar
TM channel $5 \cdot 10^{-3}$ to 500 mbar
 $3.7 \cdot 10^{-3}$ to 370 Torr

Note

The relay outputs also have been designed to handle
signals for programmable controls.

1.2.5 Chart recorder outputs

Each measurement channel has its own chart recorder
output.

Voltage range 0 to 10 V (nominal)
(Limits - 0.6 V to + 10.6 V)

Load resistance $R_{\text{ext}} \geq 2.5 \text{ k}\Omega$

Output voltage in the
event of a fault 10.2 V to 10.6 V

Characteristic linear / logarithmic

PENNING
log. 1.43 V / decade
(0 V \cong $1 \cdot 10^{-9}$ mbar)
linear: 0 - 10 V \cong 0 - $1 \cdot 10^{-7}$ mbar
0 - 10 V \cong 0 - $1 \cdot 10^{-6}$ mbar
0 - 10 V \cong 0 - $1 \cdot 10^{-5}$ mbar
:
:
0 - 10 V \cong 0 - $1 \cdot 10^{-2}$ mbar

THERMOVAC
log. 1.67 V / decade; (0 V \cong $1 \cdot 10^{-3}$ mbar)
0-10 V \cong $5 \cdot 10^{-4}$ - 1000 mbar (1,587 V / decade)
linear: 0 - 10 V \cong 0 - $1 \cdot 10^{-2}$ mbar
0 - 10 V \cong 0 - $1 \cdot 10^{-1}$ mbar
0 - 10 V \cong 0 - $1 \cdot 10^0$ mbar
:
:
0 - 10 V \cong 0 - 1000 mbar

Reaction time 100 ms approx.

Resolution 2.5 mV (12 bit)

Deviation of the displayed value ± 2 %

1.2.6 AC power requirements

Line voltage (selectable) 100 V, 120 V
200 V, 230 V
 $+10$ % / -15 %

Line frequency 50 to 60 Hz

Power consumption 35 VA

1.2.7 High voltage control input (only for PENNINGVAC)

Input voltage 0 to 24 V DC

Max. input voltage range - 33 V to + 33 V

PC compatible logic level (LOW) < 7 V; 0 A

PC compatible logic level (HIGH)
> 13 V; 7 mA (at 24 V)

Contact via relay approx. 24 V, supplied by the instrument across a protection resistor

1.2.8 Mechanical data

Dimensions (WxHxD) in mm 106.5 x 128.5 x 285.5

Installation depth 375 mm

Weight 2.3 kg

1.2.9 Ambient conditions

Operating temperature 0 °C to 40 °C

Storage temperature -40 °C to 60 °C

Max. rel. humidity 80 % non-condensing

1.2.10 RS 232 C interface

Baud rate 2400, fixed

Data format ASCII character set
one start bit,
seven data bits + one space bit,
one stop bit
no parity

Signal level ± 8 V approx.

Operating modes for the single- and multi-channel instruments of the A-series

- Talk-only operation automatic output of measurement data every 10 s, in the event of a fault output of the status message instead of the measurement data

- Remote operation data acquisition, status messages, parameter entry (depending on the total pressure gauge used)

Connection plug Sub-D socket, 9-way

Active lines TxD (Transmit data) on pin 2
RxD (Receive data) on pin 3
GND signal ground on pin 5

Status signal DTR (Data terminal ready) on pin 6
RTS (Request to send) on pin 8

Shield pin 9

Max. cable length 20 m

1.3 Technical description

1.3.1 COMBIVAC CM 31

This combination instrument is equipped with three measurement channels, two THERMOVAC channels and one PENNINGVAC. Thus it is possible to measure and control the vacuum in over 12 decades ranging between $1 \cdot 10^{-9}$ mbar and atmospheric pressure. Six switching thresholds, three logarithmic chart recorder outputs and the self-monitoring facility permit integration of the COMBIVAC CM 31 into complex vacuum control arrangements. The two THERMOVAC channels are immediately active as soon as the line voltage is applied. The PENNINGVAC channel may be switched on and off through the second THERMOVAC channel (TM 2), externally or manually via HV-key; see also Section 2.3.6.

All operating modes of the triggers and the gauges are displayed and also signalled to the corresponding outputs.

1.3.2 THERMOVAC method of measurement (Pirani)

This method of measurement for the pressure range of $5 \cdot 10^{-4}$ to 1000 mbar makes use of the thermal conductivity of the residual gas. In order to obtain response times which are as short as possible, all THERMOVAC instruments rely exclusively on the principle of the controlled Pirani gauge.

The filament is part of a Wheatstone bridge. If the temperature of the filament changes due to a change in the pressure, the bridge then becomes unbalanced. A fast-acting control circuit then adapts the heating power applied to the filament, so that filament temperature again reaches its nominal value and the bridge is rebalanced. The pressure readings obtained in this way depend on the type of gas. Normally the readings of the instruments are calibrated for nitrogen or air, with Argon being selectable.

The mechanical design of the gauge heads is very rugged and so, that dust cannot enter the electronics housing. Six types of sensors are available:

- TR 201 DN 10 KF / TR 211 DN 16 KF with tungsten filament for all standard applications
- TR 205 DN 16 CF which are bakeable and
- TR 206 DN 10 KF / TR 216 DN 16 KF with a nickel / platinum filament and of a corrosion protected design.

1.3.3 PENNINGVAC method of measurement (cold cathode)

To measure the pressure a gas discharge is ignited within the sensor by applying a high voltage. The resulting ion current is outputted as a signal which is proportional

to the prevailing pressure. A new sensor design permits safe and reliable measurement operation of this „inverted Penning“ in the pressure range between $1 \cdot 10^{-9}$ mbar and $1 \cdot 10^{-2}$ mbar. This sensor is available fitted with either a KF or a CF flange. The special alloy used for the magnet permits baking out of the sensor (with CF flange) up to 250 °C without having to remove the magnet. The rugged electrodes may be simply taken out and inserted again for cleaning or replacement.

1.3.4 RS 232 C interface

The interface will operate either in connection with a printer, remote control terminal or a computer.

The RS 232 C interface is suitable for transmitting data over distances up to 20 m. By using converters such as for example RS 422 or fibre optical links, much greater distances can be covered. Moreover, with the aid of a modem (modulator for transmission in the audio range and demodulator for converting the signals back to digital) data may be transmitted down phone lines.

1.4 Equipment

1.4.1 Supplied equipment

	Cat. No.
COMBIVAC CM 31	
Europe 230 V; mbar	157 89
USA 120 V; Torr	896 89
Japan 100 V; Torr	897 89
Operating Instructions	GA 09.504
	Ref. No.
2 fuses T 0.315 A	520 25 310
2 fuses T 0.630 A	520 25 313
Power cord 2 m (depending on CM 31 version)	
Europe	200 59 051
USA / Japan	200 27 550
Two 4-way screw terminal strips	200 60 806
One 5-way screw terminal strip	200 60 807
Three 8-way screw terminal strips	200 60 808
Four screws M 3 x 8 mm	200 80 029
Support stand for table use	200 60 900
Four adhesive feet	229 48 120

1.4.2 Accessories

	Cat. No.
THERMOVAC gauge head TR 201, DN 10 KF	162 02
THERMOVAC gauge head TR 201, 1/8" NPT	896 72
THERMOVAC gauge head TR 205, DN 16 CF	158 50
THERMOVAC gauge head TR 206, DN 10 KF	162 31
THERMOVAC gauge head TR 211, DN 16 KF	157 85
THERMOVAC gauge head TR 211, 1/8" NPT	896 33
THERMOVAC gauge head TR 216, DN 16 KF	157 87
Replacement sensing cell TR 201, DN 10 KF	162 09
Replacement sensing cell TR 201, 1/8" NPT	896 76
Replacement sensing cell TR 205, DN 16 CF	158 51
Replacement sensing cell TR 206, DN 10 KF	162 32
Replacement sensing cell TR 211, DN 16 KF	157 75
Replacement sensing cell TR 211, 1/8" NPT	896 34
Replacement sensing cell TR 216, DN 16 KF	157 77
Gauge head cable 5 m for TR gauges	162 26
Gauge head cable 10 m for TR gauges	162 27
Gauge head cable 20 m for TR gauges	162 28
Extension cable 20 m for TR gauges	160 77
THERMOVAC gauge head simulator T 210	157 10
PENNINGVAC gauge head PR 25, DN 25 KF	157 54
PENNINGVAC gauge head PR 35, DN 40 KF	157 51
PENNINGVAC gauge head PR 36, DN 40 CF	157 53
Gauge head cable 5 m for PR gauges	162 88
Gauge head cable 10 m for PR gauges	162 89
Gauge head cable 20 m for PR gauges	157 56
Gauge head cables up to 100 m	upon request
Test gauge T 35 (PENNINGVAC)	157 62
Installation frame 19", 3 HU	161 00
Cover panel 1/4 19", 3 HU	161 02

2 Operation

2.1 Start-up

Please refer to the technical data of this instrument to determine whether or not this instrument suits your application.

For safety reasons please check the following before connecting the instrument to the AC power:

- The correct line voltage setting (on the rear) see Fig. 1.
If it has to be changed, refer to Section 2.2.1
- The use of the correct line fuse.
For this refer to Section 2.2.1.

The COMBIVAC CM 31 is supplied ready for immediate use.

Connect the gauge head via the corresponding gauge head cable (refer also to Section 2.4).

Connect the AC power voltage to the CM 31 via the supplied power cord. After applying power to the instrument it runs a self test. When in progress, all display elements come on briefly.

Depending on the operational status of your vacuum system you will now get a corresponding pressure reading. Via keys TM 1, TM 2 or PM it is possible to select the required gauge head.

Check or adjust the equipment parameters as appropriate according to Section 2.3.9.

Note

After having applied the mains voltage and after completion of the self test or after having exchanged a sensor

(TM channel) „TEST“ and „noSEn“ will be displayed alternately for 1 to 5 seconds. While this is in progress the instrument is trying to determine which THERMO-VAC sensor is connected to the TM channel.

2.2 Electrical connection

Caution



Before applying power to the instrument for the first time, please carry out the following steps:

- Check and if required adapt the line voltage setting to the local line voltage.
- Check and if required exchange the built-in line fuse (see Section 2.2.1).

The line voltage of the CM 31 is set to the value which is indicated upright on the AC power socket (legible) and which points to the arrow (1/3) on the right side.

Integrated into the AC power socket is the line fuse and the voltage selector for 4 different line voltage ranges.

The line voltage is applied to the instrument via the supplied detachable power cord. An AC power socket (7/5) is provided on the rear for connection of the power cord.

Warning



Only 3-conductor power cords with safety ground may be used. The instrument may not be operated with an unconnected safety ground conductor.

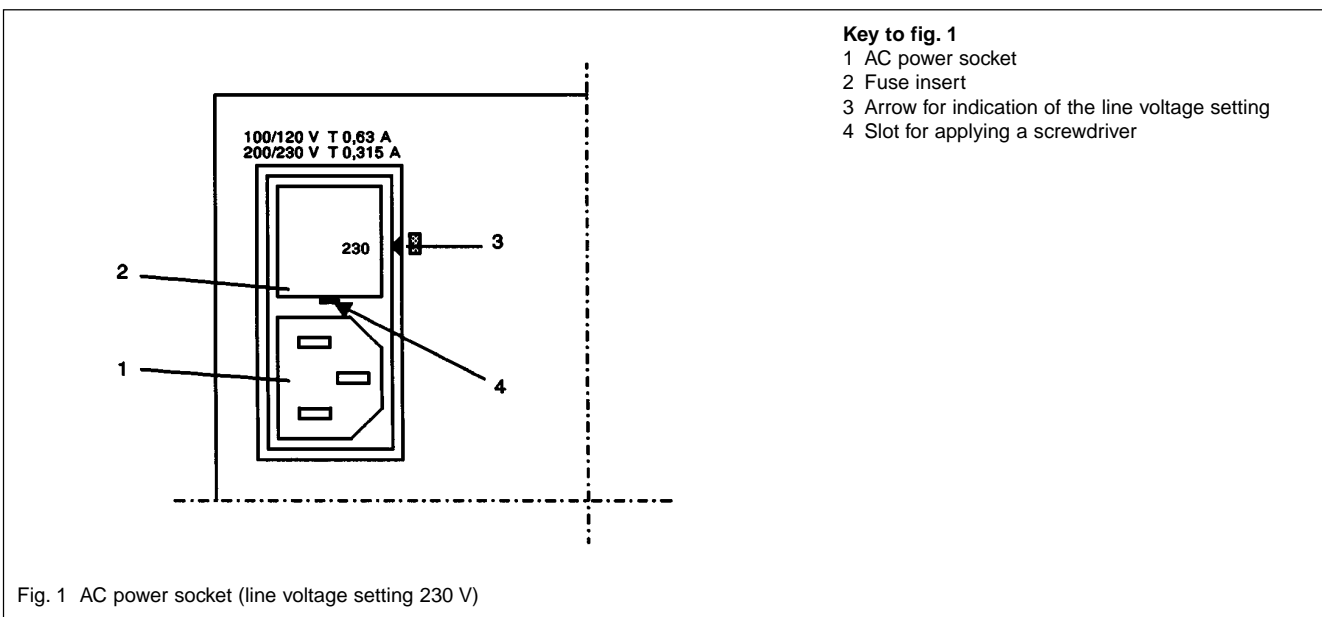

2.2.1 Changing the line voltage setting and exchanging the fuses



To change the line voltage setting or exchange a fuse the power cord must be disconnected first.

To change the line voltage setting use a screwdriver to remove the fuse holder (1/2) next to the socket (1/1). Change the orientation of the fuse holder so that the required voltage can be read upright pointing to the mark (1/3). Insert the fuse holder (1/2), while at the same time maintaining the orientation found.

Having changed the line voltage setting one of the following fuses is required:

- 100 V: AC fuse T 0.63 A (Ø 5 x 20 mm)
- 120 V: AC fuse T 0.63 A (Ø 5 x 20 mm)
- 200 V: AC fuse T 0.315 A (Ø 5 x 20 mm)
- 230 V: AC fuse T 0.315 A (Ø 5 x 20 mm)

2.3 Controls and their functions

An overview of the placement of the controls and the display elements is given in Fig. 2.

The instrument is operated via 7 keys.

Note

When pressing a key which has no function in that particular operating mode, symbol (2/9) comes on.

2.3.1 Bar graph display

The bar graph display (2/7) displays the measured value in an analog manner with a log. scale. The arrows at both ends of the bar graph display indicate an overrange or underrange condition. Depending on the measurement principle either the upper scale (exponents -3 to +3) or the lower scale (exponents -8 to -2) will be in use. When selecting the measurement unit Pa or Micron the scales will remain unmarked.

Key to fig. 2

- 1 Key HV
- 2 Key PM
- 3 Key TM 2
- 4 Key TM 1
- 5 Status display area
- 6 Over- and underrange indicators
- 7 Bar graph display
- 8 Digital display
- 9 Indicator referring to the Operating Instructions
- 10 Measurement units
- 11 Equipment fault
- 12 Key PARA
- 13 Increment parameter
- 14 Decrement parameter

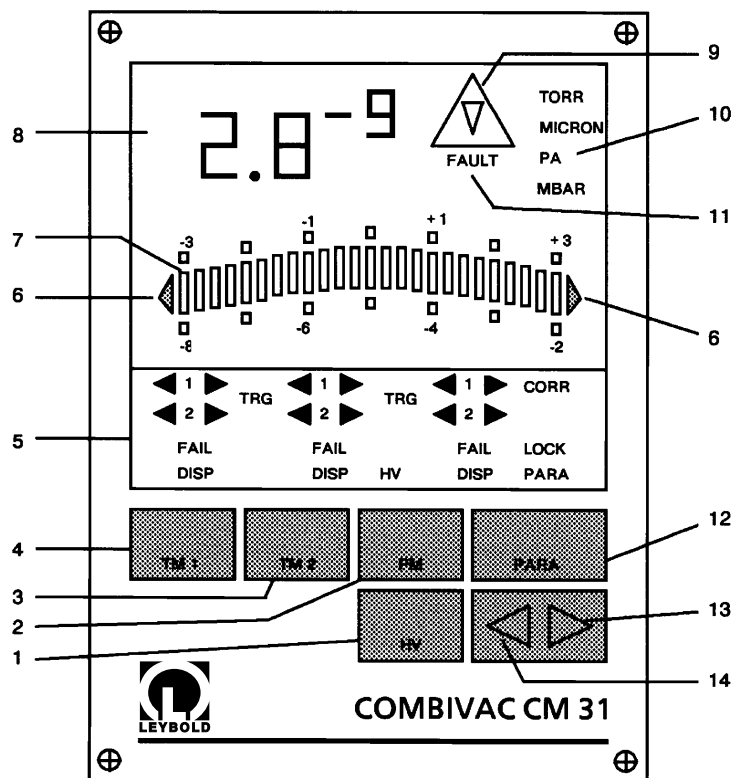

Fig. 2 Arrangement of controls and displays

2.3.2 Digital display

The digital display (3/3) is used to digitally display the pressure with respect to the selected measurement unit.

In case of Torr, Pa and mbar the readout is composed of mantissa and exponent.

When selecting Micron the readout is composed only of 5 digits. Above 99000 Micron the readout automatically changes over to Torr. $1.0 \cdot 10^2$ Torr is indicated, and all subsequent readings will be in Torr.

When the pressure drops below to $9.0 \cdot 10^1$ Torr the display will then automatically return to the unit Micron. The CM 31 will then display 90000 Micron and all subsequent readings will be in Micron again. The lowest displayed reading is 1 Micron.

2.3.3 Measurement units

Located to the right of the digital display is the display for the pressure units (3/4). Only that unit will be indicated which has previously been selected via parameter page 6.

When selecting the Micron pressure unit the reading will change between Micron and Torr depending on the pressure; (see Section 2.3.2).

2.3.4 Status display area

The status display area (3/1) for the measurement channels is located between the area of the keys and the pressure display.

Trigger and equipment modes are indicated in the status display area (3/1). These are related to the keys below which are used to select the measurement channel. An overview giving the arrangement of the trigger and equipment status modes is shown in Fig. 3. Details are described briefly in the following.

Trigger 1 (< 1 >)

The triggers as indicated in the status display area and by the status displays relate to the measurement channel which is selected by the key below.

If the left arrow of the trigger display is on, this indicates that the actual pressure is lower than the trigger set point.

If the right arrow of the trigger display is on, this indicates that the actual pressure is higher than the trigger set point.

Trigger 2 (< 2 >)

The same as for trigger 1 also applies to trigger 2.

FAIL

The word FAIL comes on in the event of a sensor failure; see Section 2.9.

DISP

DISP indicates the channel, the values of which are just being displayed. Here for example TM 1, TM 2 or PM.

HV

The HV (high vacuum gauge) message comes on, when the high voltage for the PM channel is present.

CORR

The CORR message comes on, when a different type of gas other than the standard gas „air / nitrogen“ has been

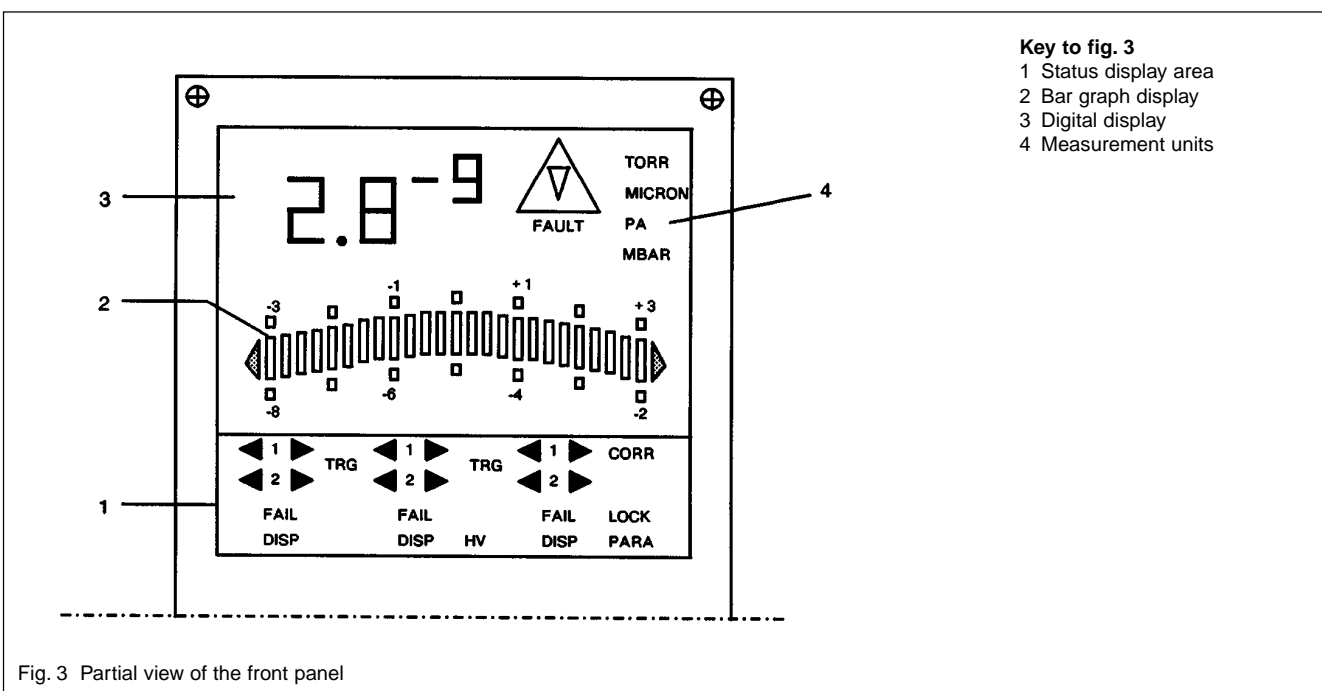

selected on parameter page 5.

LOCK

The LOCK message comes on, when the entry of parameters via the keyboard has been locked. For this refer to Section 2.3.9.2.

PARA

The PARA message comes on, when entering instrument parameters. The entered instrument parameters apply to the currently selected and displayed measurement channel.

2.3.5 Keys TM 1, TM 2 and PM

Pressing key TM 1, TM 2 or PM selects the corresponding measurement channel. The pressure of the selected measurement channel is then displayed by displays (3/2) and (3/3).

The trigger and chart recorder outputs of all channels present is not influenced in any way by the selection of a particular measurement channel.

2.3.6 Key HV

The HV key (4/1) is used to switch the high voltage for the PM channel on and off.

After switching on the PM high voltage a value is indicated immediately, provided the PM channel has been selected. 10 s after switching on the high voltage the instrument checks whether the gauge tube has ignited and whether the pressure has risen above $5 \cdot 10^{-9}$ mbar. As long as these conditions have not been met „FAIL“ will be

displayed and the triggers will not be active.

However, if these conditions have been met once after switching on, the instrument will indicate that it is ready. Thereafter the triggers are active, independently of the pressure, cable or sensor conditions until the high voltage is switched off again.

Warning



Even in the presence of an error message the PM high voltage (3.3 kV) will remain switched on.

Note

- PENNINGVAC gauges should only be switched on at pressures below $1 \cdot 10^{-2}$ mbar. Due to the physical principle employed, any PENNINGVAC gauge can be switched on at higher pressures (HV-on).
- After switching on the high tension, the gas discharge is started in the sensor with a voltage of 3.3 kV. After successful ignition this voltage is then reduced to an 1.6 kV operating level. This increases the service life of the sensors, in particular in connection with argon atmospheres.

When switching on the PENNINGVAC gauge at pressures over $1 \cdot 10^{-2}$ mbar the display will indicate an unspecified value. Prolonged operation in this unpermitted pressure range may lead to increased contamination of the gauge.

More details on the operation of this key are given on parameter page 7 „Switching the PENNINGVAC on and off automatically“.

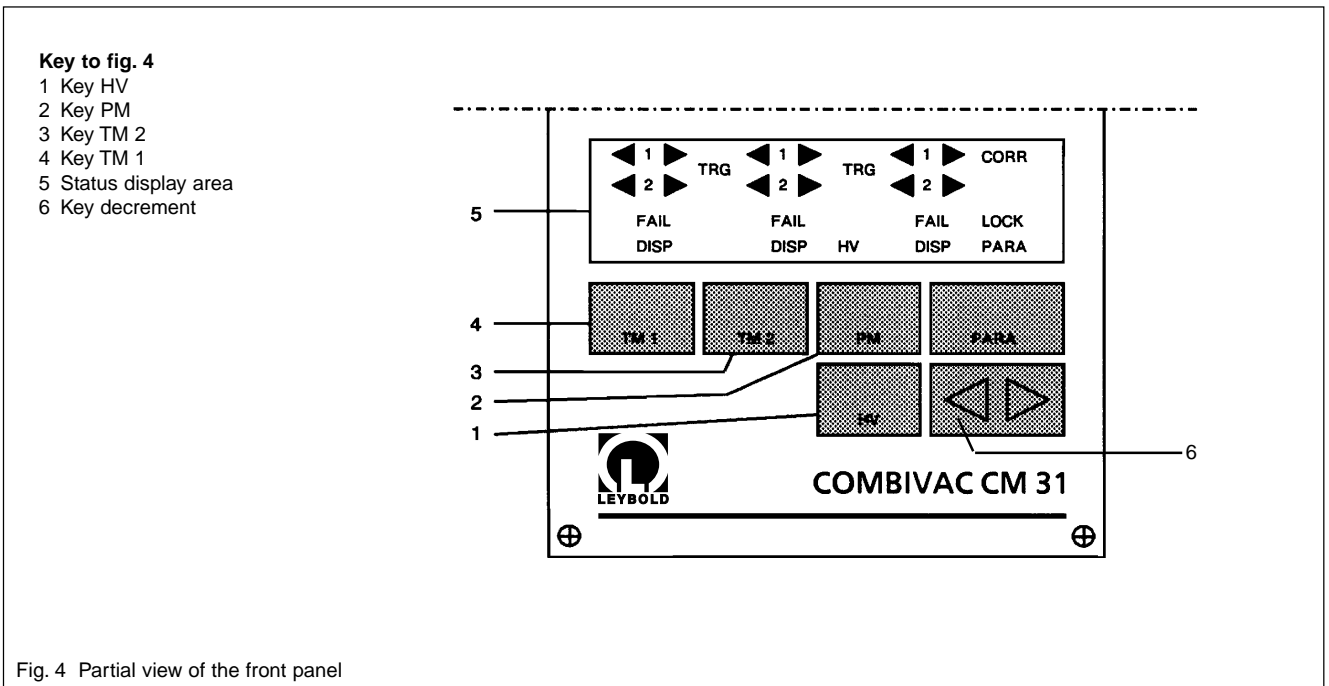

Fig. 4 Partial view of the front panel

2.3.7 Key Decrement

The decrement key (5/3) is used for setting up the triggers and other instrument parameters. Each time this key is pressed, the displayed mode is decremented by 1; in the case of numeric values the least significant digit is decremented by 1.

When pressing the decrement key for more than 2 s while setting up the triggers, the range of values will pass through rapidly.

2.3.8 Key Increment

The increment key (5/2) is used for setting up the triggers and other instrument parameters. Each time this key is pressed, the displayed mode is incremented by 1; in the case of numeric values the least significant digit is incremented by 1.

When pressing the increment key for more than 2 s while setting up the triggers, the range of values will pass through rapidly.

2.3.9 Key PARA

The „PARA“ key (5/1) is used for switching the instrument to the parameter mode, where individual parameters of the instrument may be checked, set up or where the parameter settings may be locked.

Note

The preselected setting (see setting AUTO.1) for pressure dependent switching of the PENNINGVAC channel through Thermovac channel 2 is displayed at pressures above (below) the threshold of the TM 2 channel (PM channel). When then pressing the key PM (TM 2) the corresponding pressure reading of the PM channel (TM 2 channel) will be displayed. After 1 minute the display will automatically revert back to the TM 2 channel (PM channel).

2.3.9.1 Checking and setting up of the equipment parameters

The PARA (5/1) key is pressed when wanting to check or change the settings of the various instrument parameters. The PARA message in the status display area comes on and the first parameter page of the currently selected measurement channel is displayed.

Pressing the PARA key once more selects the next parameter page.

The currently selected parameter page number is indicated by the bar graph display (2/7). The number of active bars (starting from the right hand side) corresponds to the number of the currently selected parameter page. For technical reasons only parameter page numbers starting with No. 3 are displayed in this way, i.e.: 3 bars correspond to parameter page 3, 4 bars correspond to parameter page 4 etc.

On the individual parameter pages, the parameters themselves may be changed by the decrement key (5/3) and the increment key (5/2). Any entries made via the decrement (5/3) or increment (5/2) keys become immediately effective.

Note

When no key is operated for approximately 1 minute the CM 31 will automatically switch back to the measurement mode, whereby the settings which were displayed at the time of leaving the parameter page are stored.

If no changes in the display are noticeable when operating the decrement (5/3) or increment (5/2) keys, access to the parameter entry mode has been locked beforehand. This condition is also indicated by the LOCK message.

The parameter mode may be left by

- operating any measurement channel selection key or
- automatically after displaying the last parameter page.

All changes will become stored and active automatically.

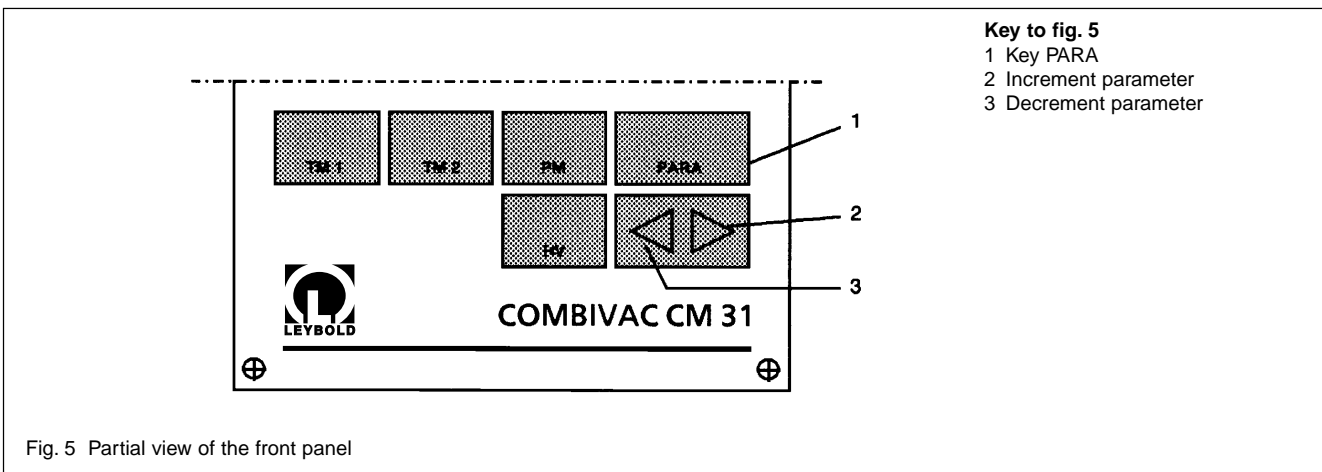

A difference is made between two levels of parameters.

Parameter level 1

Entering the parameter level 1 the following will be shown:

Page 1

The current trigger relays value for trigger 1.

If no sensor, or a faulty sensor is connected to the THERMOVAC channel or if the high voltage for the PENNING-VAC channel is off, the two arrows of trigger 1 will be flashing.

When the TM-channel is ready, or if the PM high voltage is on, the left hand arrow will flash when the current trigger value is lower than the measured pressure.

When the THERMOVAC channel is ready, or if the PM high voltage is on, only the right hand arrow will flash when the current trigger value is higher than the measured pressure.

Trigger levels when shipped:
 TM 5·10⁻³ mbar / 3.7·10⁻³ Torr
 PM 1·10⁻⁸ mbar / 7.5·10⁻⁹ Torr

Page 2

Current trigger relays value for trigger 2. Here the same applies as for page 1.

Page 3

Setting up the operating modes „Level trigger“ or „Interval trigger“.

The diagrams given in Fig. 6 provide an overview of the

two trigger modes.

L Level trigger

Both trigger outputs are operated independently of each other. Thresholds may be set up either within the range between 1·10⁻⁸ and 1·10⁻² mbar for PM measurement channel or for TM measurement channel between 5·10⁻³ and 500 mbar.

Pressure dependent hysteresis is shown in tables 3 and 4 or tables 7 and 8 of Section 2.10.

I Interval trigger

Operation of the two triggers (trigger 1 and trigger 2) is linked. When entering the thresholds the following condition must be met:

Trigger threshold 1 < trigger threshold 2

The set up interval (difference between threshold 1 and 2) cannot decrease 5 % of the value for threshold 1.

In this mode, output 2 operates as a level trigger and output 1 operates as the interval trigger.

When switching from the level trigger mode to the interval trigger mode threshold 1 must be < threshold 2. If it is not

L (for Level) and the symbol 

will be displayed referring to the Operating Instructions. At the same time the digits 1 and 2 of the < 1 > or < 2 > display will be displayed flashing.

The condition of trigger threshold 1 < trigger threshold 2 must be met first before switching over.

Setting when shipped: L (Level trigger)

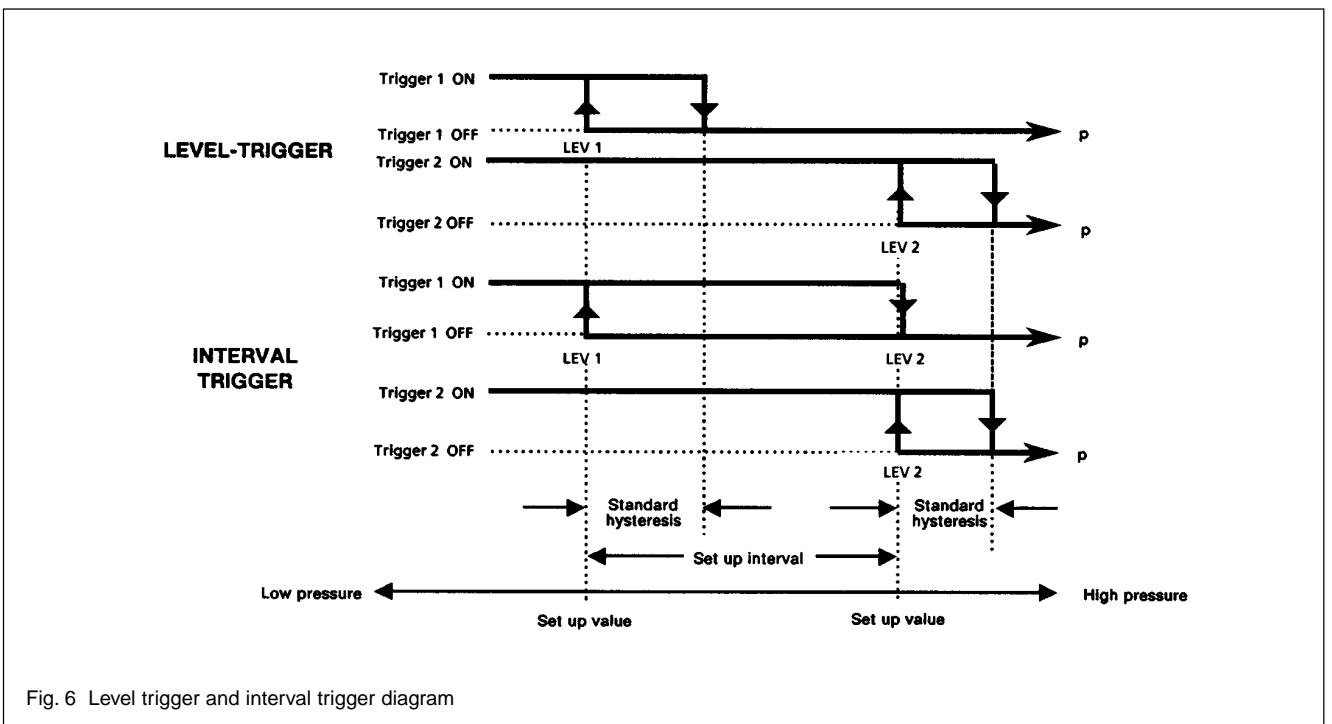

Fig. 6 Level trigger and interval trigger diagram

Page 4

Correction for the type of gas

GAS.n2 $\hat{=}$ Air / Nitrogen (N₂)

GAS.Ar $\hat{=}$ Argon

Setting when shipped: Air / Nitrogen

For a more accurate determination of the true pressure for gases other than air or N₂ in the system, the displayed value has to be multiplied by a factor which is characteristic for the other type of gas.

Gas	Correction factor	
O ₂	0,88	The correction factors
He	4,7	refer to the setting
H ₂	2,28	for GAS.n2 in each case.
Ne	2,16	

Page 5

Software release number and locking (LOCK); refer also to Section 2.3.9.2.

The transition from the parameter mode to the normal measurement mode is made by pressing the key of the desired measurement channel (TM 1, TM 2 or PM) or by pressing the PARA key.

Parameter level 2

Parameter level 2 is called up by pressing the **increment** (2/13) key when parameter page 5 is being displayed.

Parameter level 2 contains the following:

Page 6

Units of measurement TORR, PA, MICRON, MBAR

The currently active unit flashes.

Note

The unit which is set up here, applies to all three connected measurement channels.

Supplied condition: MBAR (230 V model)
TORR (100 V or 120 V model)

Even when selecting the unit „MICRON“ for a TM channel, the pressure readings for the PM channel will always be in „TORR“.

If the TM channels are to be set to „MICRON“ this can not be done via the PM channel. This is only possible when having previously selected a TM channel.

Page 7

Note

On parameter page 7 of instrument parameter level 2 there are different displays for the THERMOVAC channel and the PENNINGVAC channel.

Page 7 for the THERMOVAC channel

Filament material of the connected sensor (FILAMENT).

FIL tu Tungsten TR 211, TR 201 and TR 205

FIL ni Nickel TR 206

FIL pt Platinum TR 216

Setting when shipped: FIL tu

Page 7 for the PENNINGVAC channel

Instrument parameter page 7 is used for automatic, pressure dependent switching of the PENNINGVAC channel.

After calling up instrument parameter page 7 the display will indicate AUTO.0 or AUTO.1

AUTO.0 The high voltage may be switched on and off via the „HV“ key or via the external input HV-ON. The status of the PENNINGVAC channel is not controlled via the measurement channel TM 2.

AUTO.1 Depending on the pressure the high voltage is switched on and off through measurement channel TM 2. The high voltage may be switched off and on at any time by pressing the „HV“ key or through the external input HV-ON, provided the pressure is below $1 \cdot 10^{-2}$ mbar.

The threshold pressure for

- switching on the high voltage is:

< $1 \cdot 10^{-2}$ mbar = $7.5 \cdot 10^{-3}$ Torr = 1 Pa = 8 Micron

- switching off the high voltage is:

> $5 \cdot 10^{-2}$ mbar = $3.75 \cdot 10^{-2}$ Torr = 5 Pa = 37 Micron

In the case of automatic operation, the pressure display is switched to the best measurement channel (TM 2/PM) depending on the pressure. In the event of a faulty sensor in channel TM 2 the high voltage has to be switched on by the operator.

The display switches from the THERMOVAC channel to the PENNINGVAC channel at a pressure of $< 3 \cdot 10^{-3}$ mbar ($2.5 \cdot 10^{-3}$ Torr) and from the PENNINGVAC channel to the THERMOVAC channel at a pressure of $> 5 \cdot 10^{-3}$ mbar.

Having actuated the keyboard the change-over can be delayed by 1 min.

Setting when shipped: AUTO.1

Page 8

Equipment parameter page 8 is used for switching the numerical display from standard resolution (2-digit mantissa) to high resolution (3-digit mantissa).

Std Standard resolution 3.0^{-2}

HIGH High resolution 3.00^{-2}

For this refer to tables 3 and 4 in Section 2.10.1 or tables 7 and 8 in Section 2.10.2.

Page 9

Note

On parameter page 9 of instrument parameter level 2 there are different displays for the THERMOVAC channel and the PENNINGVAC channel.

Page 9 for the THERMOVAC channel (TM)

Cable length adjustment for the THERMOVAC gauges.

Note

Equipment parameter page 9 is used to enter the length of the cable for THERMOVAC gauge heads.

After calling up parameter page 9 the display will indicate „CL xxx“.

CL Cable length
xxx Length in m

By operating the increment or decrement keys it is possible to enter cable lengths in the range between 0 m and 100 m in 5 m increments (5 m, 10 m, 15 m, 20 m, 25 m etc.). The default setting is 5 m.

Note

Intermediate values must be rounded off.

The values only apply to standard cables 6 x 0.14 mm².

Note

When combining a TR 211 gauge from series B1 or later or a TR 215 / 216 and TM channel from software revision 2.0 or later the length of the gauge head cable is automatically accounted for by means of automatic cable length alignment. „CLA“ will be displayed on parameter page 9.

Page 9 for the PENNINGVAC measurement channel (PM)

Adjustment of the analogue output (for this also see Section 2.10.3).

Seven different ranges can be set up.

Logarithmic output characteristic:

Ano⁻⁸ : log 1·10⁻⁹ - 1·10⁻² mbar (1.43 V / decade)

Linear output characteristic:

	0	0,1	1	...	5 V	...	10 V
AnI ⁻⁷ :	1·10 ⁻⁹	1·10 ⁻⁸					1·10 ⁻⁷ mbar
AnI ⁻⁶ :	1·10 ⁻⁸	1·10 ⁻⁷					1·10 ⁻⁶ mbar
AnI ⁻⁵ :	1·10 ⁻⁷	1·10 ⁻⁶					1·10 ⁻⁵ mbar
AnI ⁻⁴ :	1·10 ⁻⁶	1·10 ⁻⁵					1·10 ⁻⁴ mbar
AnI ⁻³ :	1·10 ⁻⁵	1·10 ⁻⁴					1·10 ⁻³ mbar
AnI ⁻² :	1·10 ⁻⁴	1·10 ⁻³					1·10 ⁻² mbar

Page 10 for the THERMOVAC measurement channel (TM)

Adjustment of the analogue output (for this also see Section 2.10.2).

Eight different ranges can be set up.

Logarithmic output characteristic:

Ano⁻³ : log 1·10⁻³ - 1000 mbar (1.67 V / decade)

Ano⁻⁴ : log 5·10⁻⁴ - 1000 mbar (1.587 V / decade)

Linear output characteristic:

	0	0,1	1	...	5 V	...	10 V
AnI ⁻² :	1·10 ⁻⁴	1·10 ⁻³					1·10 ⁻² mbar
AnI ⁻¹ :	1·10 ⁻³	1·10 ⁻²					1·10 ⁻¹ mbar
AnI ⁺⁰ :	1·10 ⁻²	1·10 ⁻¹					1·10 ⁺⁰ mbar
AnI ⁺¹ :	1·10 ⁻¹	1·10 ⁺⁰					1·10 ⁺¹ mbar
AnI ⁺² :	1·10 ⁺⁰	1·10 ⁺¹					1·10 ⁺² mbar
AnI ⁺³ :	1·10 ⁺¹	1·10 ⁺²					1·10 ⁺³ mbar

2.3.9.2 Locking of parameter settings

By locking the parameter settings, the entered and stored parameters may be protected against any unqualified changes.

When parameter page 5 is displayed (software release number) pressing the PARA key of the TM 1 measurement channel for more than 5 seconds will lock up all parameters and prevent any further parameter changes. The „LOCK“ message will come on. With the „LOCK“ message on, it is only possible to check the settings of the parameters. However, keys TM 1, TM 2 and PM remain accessible.

Unlocking is only possible by displaying the number of the software release of the TM 1 measurement channel once more (parameter page 5) and by pressing the PARA key for more than 5 seconds.

2.4 Supply and socket connections on the rear

All supply connections and sockets are located on the rear. These are shown in Fig. 7.

2.4.1 AC power supply

Connection to the AC power and selection of a different line voltage setting and exchanging the line fuse of the CM 31 is described in Section 2.2.

2.4.2 Connection of the THERMOVAC gauge

The THERMOVAC gauge heads for measurement channels TM 1 and TM 2 are connected to sockets (7/4) and (7/10) respectively.

2.4.3 Connection of the PENNINGVAC gauge



The PENNINGVAC sensor is supplied with a high tension via socket (7/9). (3.3 kV ignition voltage, 1.6 kV operating voltage; $R_i = 7.7 \text{ M}\Omega$)

This socket is wired as follows:
 Inner conductor Positive high voltage
 Outer conductor Return and screen

2.4.4 Screw terminal outputs for the THERMOVAC channels

The connections are carried via two terminal strips. One 4-way terminal strip (7/6) or (7/7) above, and one 8-way terminal strip (7/3) or (7/12) under the gauge head connector. Those terminal strips which are above each other are always related to one THERMOVAC channel. The wiring is the same for both measurement channels but the numbering of the pins is **different**.

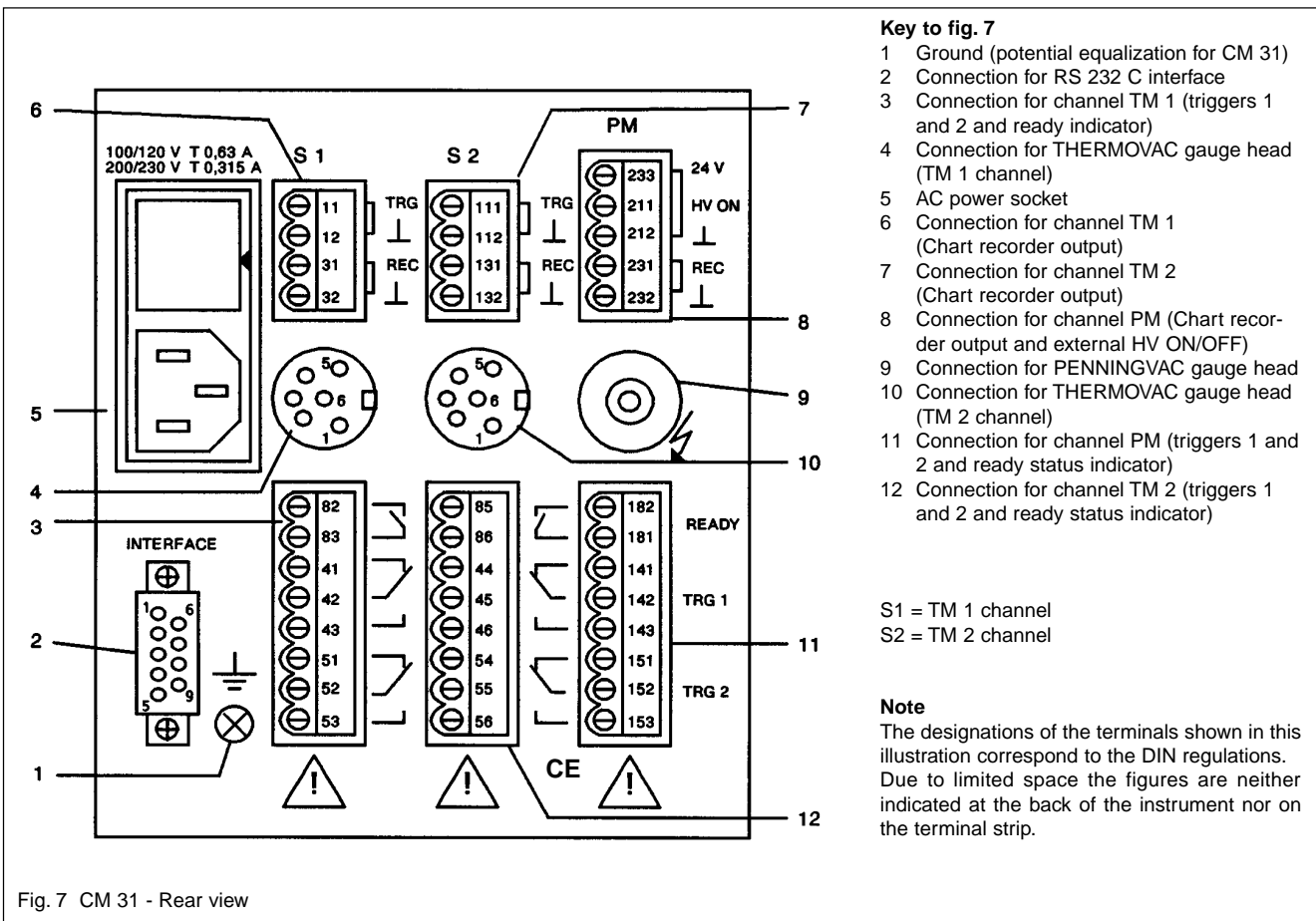









Fig. 7 CM 31 - Rear view

The 4-way terminal strip is wired as follows (Fig. 7)

TM 1	TM 2	Signal
11	111	Trigger threshold (TRG) in preparation
12	112	Trigger threshold (ground) in preparat.
31	131	Chart recorder output 0 to 10 V (REC)
32	132	Chart recorder output (ground)

The 8-way terminal strip is wired as follows (Fig.7)

TM 1	TM 2	Signal	Contact symbol
82	85	C Ready	
83	86	n.o. (open)	
41	44	n.c. (closed)	
42	45	C Trigger 1	
43	46	n.o. (open)	
51	54	n.c. (closed)	
52	55	C Trigger 2	
53	56	n.o. (open)	

n.c. Normally closed (resting contact)
n.o. Normally open (operating contact)
C Common (Centre contact)

Note

The 8-way socket is specified for a max. permissible operating voltage of 250 V AC and 50/60 Hz with reference to the safety ground conductor.

2.4.5 Screw terminal outputs for the PENNINGVAC channel









The connections are carried via two terminal strips. One 5-way terminal strip (7/8) above, and one 8-way terminal strip (7/11) under the gauge head connector.

The 5-way terminal strip is wired as follows (Fig. 7)

PM	Signal
233	+ 24 approx. ($R_i = 680 \Omega$) for external contact on 211
211	HV control input for PM (HV ON)
212	Ground for HV control input
231	Chart recorder output 0 to 10 V (REC)
232	Ground for chart recorder output

For the PENNINGVAC channel the wiring of the 8-way terminal strip (7/11) is the same as for the 8-way terminal strips (7/3) and (7/12) for the THERMOVAC channels but the numbering of the pins is different!

The 8-way terminal strip is wired as follows (Fig. 7).

PM	Signal	Contact symbol
182	C Ready	
181	n.o. (open)	
141	n.c. (closed)	
142	C Trigger 1	
143	n.o. (open)	
151	n.c. (closed)	
152	C Trigger 2	
153	n.o. (open)	

n.c. Normally closed (resting contact)
n.o. Normally open (operating contact)
C Common (Centre contact)

2.4.6 RS 232 C interface

The connections are made through a 9-way Sub-D connector (3/2).

The interface socket on the A-series instruments is wired as follows:

Pin No.	Designation	Remarks
1		Not used
2	TxD	Transmission data (output)
3	RxD	Receive data (input)
4		Not used
5	GND	Reference ground for signals
6	DTR	Is pulled high (+ 8 V approx.) when the mains voltage is applied to the instrument.
7		Not used
8	RTS	Is pulled high (+ 8 V approx.) when the mains voltage is applied to the instrument.
9	Shield	Ground connection for cable shield

2.5 Installing the instrument

The CM 31 has been designed to operate reliably under all normally encountered industrial conditions (see Section 1.2.9).

The instrument is supplied with a rugged table-top housing. The metal housing is provided with ventilation slits on the top and bottom. When installing the instrument within a cabinet, sufficient ventilation must be ensured. For this, also refer to Section 1.2.9 „Ambient conditions“.

The metal housing also reliably protects the instrument against electromagnetic interferences (EMI). However, the CM 31 should be installed away from strong magnetic fields, large transformers and motors etc., so that the instrument cannot be influenced.

2.5.1 Installation

Note

When installing the CM 31, care should be taken so as not to obstruct the ventilation slits in any way. Also ensure a sufficient throughput of air.

2.5.2 Rack installation

The CM 31 is delivered for installation into a 19" rack having 3 height units.

It is inserted into the rack and secured by screwing in four mounting screws through the holes on front panel. Mounting screws are included.

2.5.3 Panel installation

The CM 31 is delivered ready for panel mounting. The required panel cut out is given in Fig. 8.

2.5.4 Using the CM 31 as a table-top instrument

When using the CM 31 as a table-top instrument a support stand (Ref. No. 200 60 900) may be fitted to the bottom of the instrument. The support is inserted from the rear into the lowermost groove of the corner profile and is then pushed to the front until it engages.

The four adhesive feet (Ref. No. 229 48 120) are attached under the support stand and under the rear of the instrument.

2.6 Checking the equipment functions

2.6.1 TM measurement channels

The THERMOVAC measurement channels are supplied factory-aligned and does not require any maintenance.

Test gauge T 210 may be used to check important equipment functions. The test gauge is a gauge head simulator for a THERMOVAC gauge head, but it does **not supply calibration values**.

By operating the potentiometer it is possible to simulate any pressure within the range between $5 \cdot 10^{-4}$ mbar and atmosphere.

This is especially useful for checking trigger thresholds and trigger reactions in vacuum systems since this checking can be carried out without starting up the vacuum pumps.

In the event of a fault in the measurement system test gauge T 210 may be used to determine whether the fault is with the gauge head, the gauge head cable or the CM 31 itself.

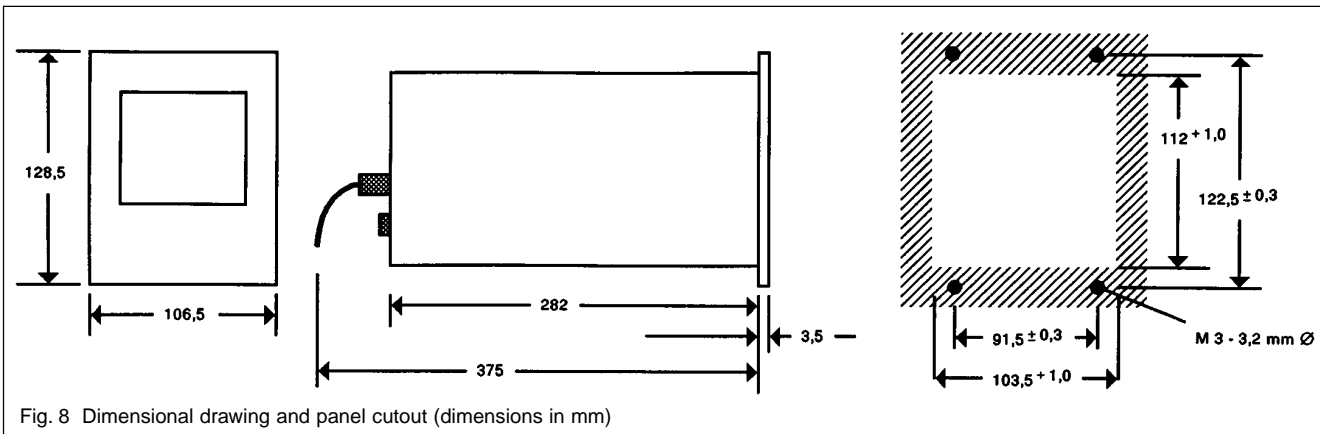

Fig. 8 Dimensional drawing and panel cutout (dimensions in mm)

2.6.2 PM measurement channel

The PENNINGVAC measurement channel is supplied factory-aligned and does not require any maintenance.

Test gauge T 35 may be used to check important equipment functions. The test gauge is a gauge head simulator for the PENNINGVAC gauge head. Different pressure values are simulated via integrated resistors and are available at three plug sockets.

The test values are indicated on the gauge head.

In the event of a fault in the measurement system test gauge T 35 may be used to determine whether the fault is with the gauge head, the gauge head cable or the CM 31 itself.

2.7 Alignment of the THERMOVAC gauge heads

Aging and contamination of the filament within the gauge head will impair the accuracy of the pressure readings. Therefore it is recommended to align the THERMOVAC gauge heads from time to time when appropriate. This alignment is carried out as follows:

Vent the vacuum system and adjust the 100 % potentiometer on the THERMOVAC gauge head so that the following bargraph display is obtained:

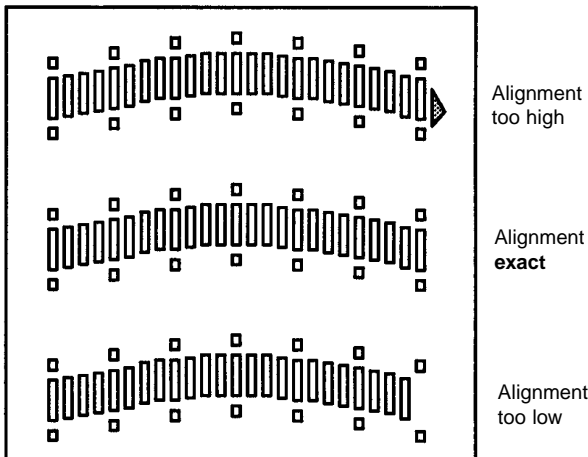

Note

In order to ensure a stable but none-the-less accurate alignment of the 100 % value, the alignment potentiometer (100 %) should be turned further by 90° in the clockwise direction after the last segment of the bargraph has come on. When doing so, the right arrow (overrange) may just come on.

Evacuate the vacuum system down to a pressure $5 \cdot 10^{-4}$ mbar and then adjust the „0“ potentiometer on the THERMOVAC gauge head so that the following bargraph display is obtained:

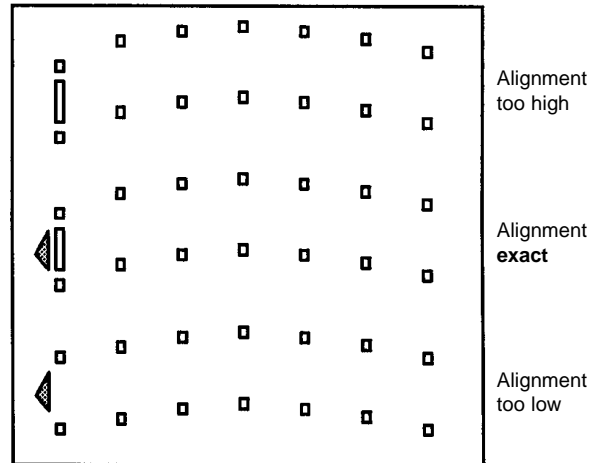

Vent the vacuum system once more and check the 100 % setting once more. If required correct any possible deviations.

If it was necessary to correct the 100 % setting, Zero alignment must be repeated.

Note

With the Torr setting the bar +3 is permanently switched off.

2.8 Switching off

The instrument is switched off simply by disconnecting the power cord.

2.9 Status messages

The COMBIVAC CM 31 is able to display a variety of status messages.

FAIL FAIL indicates that there is a fault in the sensor.

If a fault is present when selecting a THERMOVAC measurement channel, one of the following error messages is displayed:

 No sensor
 Fault cause:
 - Gauge head cable disconnected
 - Damaged cable
 - Sensor can not be identified
 - Missing sensor
 Filament broken

 Fault cause
 - Filament faulty

FAIL The following applies to the PENNINGVAC channel:

HV (high voltage) was switched on at a pressure below $5 \cdot 10^{-9}$ mbar / Torr ($5 \cdot 10^{-7}$ Pa).

Interrupted gauge head cable.

Sensor not connected.

Note

When switching on the high voltage the message „FAIL“ will appear after 10 s until the gauge tube has ignited and provided the pressure exceeds $5 \cdot 10^{-9}$ mbar.

FAULT A fault has occurred during the execution of the microprocessor program due to exceptionally strong electromagnetic interferences or a brief mains failure (1 to 3 seconds), for example. In this case the instrument or the affected measurement channel is reset to a stable through a Watchdog function:

- Display: Status FAULT, all other segments may flash
- Chart recorder output is set high to 10.2 to 10.6 V.
- The contact of the Ready relay is opened, trigger relays are set to the rest position.

Remedy:

Switch the instrument off (disconnect from the mains). Reconnect after 5 s at the earliest.



This symbol indicates that the CM 31 should be operated according to the Operating Instructions as the instrument has been operated incorrectly.

For example.: L

The triggers are set to the interval mode, but threshold 1 is higher or equal to threshold 2.

This symbol will also appear when operating a key which - in that particular operating mode - has no function. This symbol is automatically erased after some time.



FAULT

This symbol indicates the presence of a fault within the instrument.



Initialization text when changing the sensor for the TM channel.

The following applies to the PENNINGVAC channel:

 Off

Cause:

- High voltage has not been switched on.

2.10 Chart recorder output tables

2.10.1 Chart recorder output table for TM measurement channel

Table 1 Response of the chart recorder output, trigger relay and ready indicator in the TM channel

TMchannel mode	TM resdy contact	Trigger relay operating contact	Chart recorder output
AC power „OFF“	open	open	--
Immediately after AC power „ON“	open	open	10.2 - 10.6 V
AC power „ON“ after 1 s approx. and a valid measurement value	closed	open or closed depending on the pressure	0 to 10 V
broken filament	open	open	10.2 - 10.6 V
No sensor connected	open	open	10.2 - 10.6 V

Table 2 Response of the TM pressure readout at the chart recorder output for the setting Ano^{-3} .

mbar	Pa	Torr	Micron	Chart rec. output volt.
1.0·10 ⁻³	1.0·10 ⁻¹	1.0·10 ⁻³	1	0.00 V
2.0·10 ⁻³	2.0·10 ⁻¹	2.0·10 ⁻³	2	0.50 V
5.0·10 ⁻³	5.0·10 ⁻¹	5.0·10 ⁻³	5	1.16 V
9.0·10 ⁻³	9.0·10 ⁻¹	9.0·10 ⁻³	9	1.59 V
1.0·10 ⁻²	1.0·10 ⁰	1.0·10 ⁻²	10	1.67 V
2.0·10 ⁻²	2.0·10 ⁰	2.0·10 ⁻²	20	2.17 V
5.0·10 ⁻²	5.0·10 ⁰	5.0·10 ⁻²	50	2.83 V
9.0·10 ⁻²	9.0·10 ⁰	9.0·10 ⁻²	90	3.26 V
1.0·10 ⁻¹	1.0·10 ¹	1.0·10 ⁻¹	100	3.33 V
2.0·10 ⁻¹	2.0·10 ¹	2.0·10 ⁻¹	200	3.84 V
5.0·10 ⁻¹	5.0·10 ¹	5.0·10 ⁻¹	500	4.50 V
9.0·10 ⁻¹	9.0·10 ¹	9.0·10 ⁻¹	900	4.92 V
1.0·10 ⁰	1.0·10 ²	1.0·10 ⁰	1000	5.00 V
2.0·10 ⁰	2.0·10 ²	2.0·10 ⁰	2000	5.50 V
5.0·10 ⁰	5.0·10 ²	5.0·10 ⁰	5000	6.16 V
9.0·10 ⁰	9.0·10 ²	9.0·10 ⁰	9000	6.59 V
1.0·10 ¹	1.0·10 ³	1.0·10 ¹	10 000	6.67 V
2.0·10 ¹	2.0·10 ³	2.0·10 ¹	20 000	7.17 V
5.0·10 ¹	5.0·10 ³	5.0·10 ¹	50 000	7.83 V
9.0·10 ¹	9.0·10 ³	9.0·10 ¹	90 000	8.26 V
1.0·10 ²	1.0·10 ⁴	1.0·10 ²	1.0·10 ² Torr	8.33 V
2.0·10 ²	2.0·10 ⁴	2.0·10 ²	2.0·10 ² Torr	8.84 V
5.0·10 ²	5.0·10 ⁴	5.0·10 ²	5.0·10 ² Torr	9.50 V
9.0·10 ²	9.0·10 ⁴	*)	*)	9.92 V
1.0·10 ³	1.0·10 ⁵	--	--	10.00 V

*) FS: $7.6 \cdot 10^2$ Torr \cong 9.8 V

Equations for the chart recorder output (U_a) relating to the THERMOVAC measurement channel; see Table 2:

For Ano^{-3}

$$U_a = \frac{10}{6} (\log p + 3)$$

For Ano^{-4}

$$U_a = 1,58704 \cdot \log p + 5,23887$$

For AnI^{+3}

$$U_a = \frac{p}{p_{\max}} 10$$

For AnI^{+2}

$$U_a = \frac{p}{p_{\max}} 100$$

For AnI^{+1}

$$U_a = \frac{p}{p_{\max}} 1\,000$$

For AnI^0

$$U_a = \frac{p}{p_{\max}} 10\,000$$

Für AnI^{-1}

$$U_a = \frac{p}{p_{\max}} 100\,000$$

For AnI^{-2}

$$U_a = \frac{p}{p_{\max}} 1\,000\,000$$

U_a Chart recorder output voltage in V and $U_{a\max} = 10$ V

p Pressure in mbar or Torr

Example

$$p = 7 \cdot 10^{-2} \text{ mbar}$$

$$U_a = \frac{10}{6} (\log 7 \cdot 10^{-2} + 3) = \frac{10}{6} (-1.15 + 3) = 3.08 \text{ V}$$

Table 3 Display resolution and display increments

Pressure [mbar / Torr]	Increments for STD	Increments for HIGH
1.00·10 ⁻³ to 1.00·10 ⁻²	in 0.1 increments	in 0.1 increments
3.00·10 ⁻² to 6.00·10 ⁻²	in 0.1 increments	in 0.01 increments
1.00·10 ⁻¹ to 3.00·10 ⁻¹	in 0.1 increments	in 0.02 increments
6.00·10 ⁻¹ to 1.00·10 ⁰	in 0.1 increments	in 0.05 increments
etc. etc. etc. to 9.90·10 ¹	in 0.1 increments	in 0.01 increments
9.95·10 ¹ to 1.00·10 ²	in 0.1 increments	in 0.02 increments
2.00·10 ² to 3.00·10 ²	in 0.1 increments	in 0.05 increments
3.50·10 ² to 4.00·10 ²	in 0.1 increments	in 0.1 increments
5.00·10 ² to 6.00·10 ²		
8.00·10 ² **) to 1.00·10 ³ **)		

**) FS: 7.6·10² Torr

Table 4 Assignment: Measurement range, measurement uncertainty and switching hysteresis for the level trigger mode and standard resolution

mbar	Pa	Torr	Micron	Measurement uncertainty	Trigger-hysteresis Level trigger
1.0·10 ⁻³ to 4.9·10 ⁻³	1.0·10 ⁻¹ to 4.9·10 ⁻¹	1.0·10 ⁻³ to 4.9·10 ⁻³	1. 2. 3. 4	± 20 %	nicht einstellbar
5.0·10 ⁻³ to 9.9·10 ⁻³	5.0·10 ⁻¹ to 9.9·10 ⁻¹	5.0·10 ⁻³ to 9.9·10 ⁻³	5. 6. 7. 8. 9	± 20 %	+ 20 %
1.0·10 ⁻² to 9.9·10 ⁻²	1.0·10 ⁰ to 9.9·10 ⁰	1.0·10 ⁻² to 9.9·10 ⁻²	10. 11. 12... 99	± 15 %	+ 10 %
1.0·10 ⁻¹ to 9.9·10 ⁻¹	1.0·10 ¹ to 9.9·10 ¹	1.0·10 ⁻¹ to 9.9·10 ⁻¹	100. 110... 990	± 15 %	+ 10 %
1.0·10 ⁰ to 9.9·10 ⁰	1.0·10 ² to 9.9·10 ²	1.0·10 ⁰ to 9.9·10 ⁰	1000. 1100... 9900	± 15 %	+ 10 %
1.0·10 ¹ to 9.9·10 ¹	1.0·10 ³ to 9.9·10 ³	1.0·10 ¹ to 9.9·10 ¹	10000. 11000... 99000	± 15 %	+ 10 %
1.0·10 ² to 2.9·10 ²	1.0·10 ⁴ to 2.9·10 ⁴	1.0·10 ² to 2.9·10 ²	1.0·10 ² to 2.9·10 ² Torr	± 50 %	+ 20 %
3.0·10 ²	3.0·10 ⁴	3.0·10 ²	3.0·10 ² Torr	--	+ 20 %
3.5·10 ²	3.5·10 ⁴	3.5·10 ²	3.5·10 ² Torr	--	+ 20 %
4.0·10 ²	4.0·10 ⁴	4.0·10 ²	4.0·10 ² Torr	--	+ 20 %
5.0·10 ²	5.0·10 ⁴	5.0·10 ²	5.0·10 ² Torr	--	cannot be set
6.0·10 ²	6.0·10 ⁴	6.0·10 ²	6.0·10 ² Torr	--	cannot be set
8.0·10 ²	8.0·10 ⁴	7.6·10 ²	7.6·10 ² Torr	--	cannot be set
1.0·10 ³	1.0·10 ⁵	--	--	--	cannot be set

Note

The smallest possible degree of switching hysteresis for the interval trigger is + 5 % of the trigger level.

2.10.2 Chart recorder output tables for PM measurement channel

Table 5 Response of the chart recorder output, trigger relay and ready indicator in the PM channel

PM channel mode	PM-Ready contact	Trigger relay operating contact	Chart recorder output
AC power „OFF“	open	open	--
Immediately after AC Power „ON“	open	open	10.2 - 10.6 V
Immediately after „HV ON“	open	open	10.2 - 10.6 V
Measurement value ($p > 5 \cdot 10^{-9}$ mbar) present after 10 s.	closed	je nach Druck offen oder geschlossen	-0.2 - 10.2 V
No measurement value present after 10 s	open	open	10.2 - 10.6 V
HV-Off	open	open	--

Equations for the chart recorder output (U_a) relating to the PENNINGVAC measurement channel; see Table 6:

For An^{o-8}

$$U_a = \frac{10}{7} (\log p + 9)$$

For An^{l-2}

$$U_a = \frac{p}{p_{\max}} 10$$

For An^{l-3}

$$U_a = \frac{p}{p_{\max}} 100$$

For An^{l-4}

$$U_a = \frac{p}{p_{\max}} 1\,000$$

For An^{l-5}

$$U_a = \frac{p}{p_{\max}} 10\,000$$

For An^{l-6}

$$U_a = \frac{p}{p_{\max}} 100\,000$$

For An^{l-7}

$$U_a = \frac{p}{p_{\max}} 1\,000\,000$$

U_a Chart recorder output voltage in V and $U_{a\max} = 10$ V
 p Pressure in mbar or Torr

Example

$$p = 7 \cdot 10^{-3} \text{ mbar}$$

$$U_a = \frac{10}{7} (\log 7 \cdot 10^{-3} + 9) = \frac{10}{7} (-2,155 + 9) = 9,78 \text{ V}$$

Table 6 Table of examples for the PM chart recorder output at An^{o-8}.

mbar	Pa	Torr	Chart rec. output volt.
1.0·10 ⁻⁹	1.0·10 ⁻⁷	1.0·10 ⁻⁹	0.00 V
2.0·10 ⁻⁹	2.0·10 ⁻⁷	2.0·10 ⁻⁹	0.43 V
5.0·10 ⁻⁹	5.0·10 ⁻⁷	5.0·10 ⁻⁹	1.00 V
9.0·10 ⁻⁹	9.0·10 ⁻⁷	9.0·10 ⁻⁹	1.36 V
1.0·10 ⁻⁸	1.0·10 ⁻⁶	1.0·10 ⁻⁸	1.43 V
2.0·10 ⁻⁸	2.0·10 ⁻⁶	2.0·10 ⁻⁸	1.86 V
5.0·10 ⁻⁸	5.0·10 ⁻⁶	5.0·10 ⁻⁸	2.43 V
9.0·10 ⁻⁸	9.0·10 ⁻⁶	9.0·10 ⁻⁸	2.79 V
1.0·10 ⁻⁷	1.0·10 ⁻⁵	1.0·10 ⁻⁷	2.86 V
2.0·10 ⁻⁷	2.0·10 ⁻⁵	2.0·10 ⁻⁷	3.29 V
5.0·10 ⁻⁷	5.0·10 ⁻⁵	5.0·10 ⁻⁷	3.86 V
9.0·10 ⁻⁷	9.0·10 ⁻⁵	9.0·10 ⁻⁷	4.22 V
1.0·10 ⁻⁶	1.0·10 ⁻⁴	1.0·10 ⁻⁶	4.29 V
2.0·10 ⁻⁶	2.0·10 ⁻⁴	2.0·10 ⁻⁶	4.72 V
5.0·10 ⁻⁶	5.0·10 ⁻⁴	5.0·10 ⁻⁶	5.28 V
9.0·10 ⁻⁶	9.0·10 ⁻⁴	9.0·10 ⁻⁶	5.65 V
1.0·10 ⁻⁵	1.0·10 ⁻³	1.0·10 ⁻⁵	5.71 V
2.0·10 ⁻⁵	2.0·10 ⁻³	2.0·10 ⁻⁵	6.14 V
5.0·10 ⁻⁵	5.0·10 ⁻³	5.0·10 ⁻⁵	6.71 V
9.0·10 ⁻⁵	9.0·10 ⁻³	9.0·10 ⁻⁵	7.08 V
1.0·10 ⁻⁴	1.0·10 ⁻²	1.0·10 ⁻⁴	7.14 V
2.0·10 ⁻⁴	2.0·10 ⁻²	2.0·10 ⁻⁴	7.57 V
5.0·10 ⁻⁴	5.0·10 ⁻²	5.0·10 ⁻⁴	8.14 V
9.0·10 ⁻⁴	9.0·10 ⁻²	9.0·10 ⁻⁴	8.51 V
1.0·10 ⁻³	1.0·10 ⁻¹	1.0·10 ⁻³	8.57 V
2.0·10 ⁻³	2.0·10 ⁻¹	2.0·10 ⁻³	9.00 V
5.0·10 ⁻³	5.0·10 ⁻¹	5.0·10 ⁻³	9.57 V
9.0·10 ⁻³	9.0·10 ⁻¹	9.0·10 ⁻³	9.93 V
1.0·10 ⁻²	1.0	1.0·10 ⁻²	10.00 V

Table 7 Display resolution and display increments

Pressure [mbar]	Increments for STD	Increments for HIGH
9.90·10 ⁻¹⁰ to 1.00·10 ⁻⁹	in 0.1	in 0.05
3.00·10 ⁻⁹ to 6.00·10 ⁻⁹	in 0.1	in 0.01
1.00·10 ⁻⁸ to 3.00·10 ⁻⁸	in 0.1 increments	in 0.02 increments
6.00·10 ⁻⁸ to 1.00·10 ⁻⁷	in 0.1 increments	in 0.05 increments
3.00·10 ⁻⁸ to 6.00·10 ⁻⁸	in 0.1 increments	in 0.01 increments
6.00·10 ⁻⁸ to 1.00·10 ⁻⁷	in 0.1 increments	in 0.02 increments
1.00·10 ⁻⁷ usw. usw. usw. to 1.00·10 ⁻³	in 0.1 increments	in 0.05 increments
6.00·10 ⁻³ to 1.00·10 ⁻²	in 0.1 increments	in 0.01 increments
	in 0.1 increments	in 0.02 increments
	in 0.1 increments	in 0.05 increments
	in 0.1 increments	in 0.1 increments
	in 0.2 increments	in 0.2 increments

Table 8 Assignment: Measurement range, measurement uncertainty and switching hysteresis for the level trigger mode

mbar	Pa	Torr	Measurement uncertainty	Trigger hysteresis Level trigger
9.9·10 ⁻¹⁰	9.9·10 ⁻⁸	9.9·10 ⁻¹⁰	--	cannot be set
1.0·10 ⁻⁹ to 9.9·10 ⁻⁹	1.0·10 ⁻⁷ to 9.9·10 ⁻⁷	1.0·10 ⁻⁹ to 9.9·10 ⁻⁹	--	cannot be set
1.0·10 ⁻⁸ to 9.9·10 ⁻⁸	1.0·10 ⁻⁶ to 9.9·10 ⁻⁶	1.0·10 ⁻⁸ to 9.9·10 ⁻⁸	± 30 %	+ 20 %
1.0·10 ⁻⁷ to 9.9·10 ⁻⁵	1.0·10 ⁻⁵ to 9.9·10 ⁻³	1.0·10 ⁻⁷ to 9.9·10 ⁻⁵	± 30 %	+ 10 %
1.0·10 ⁻⁴ to 1.0·10 ⁻²	1.0·10 ⁻² to 1.0·10 ⁰	1.0·10 ⁻⁴ to 1.0·10 ⁻²	--	+ 20 %

3 RS 232 C interface

3.1 Description

The levels of the RS 232 C interface are defined as follows:

Level	LOW (L)	HIGH (H)
Voltage range	-3 to -25 V	3 to 25 V
Logic state	logic 1	logic 0
Level designation	Mark	Space

The interface may be operated in either of the following modes:

Printer mode

In this mode the data are output every 10 s via the interface. The instrument itself and the entry of parameters is controlled via the keyboard.

Remote control mode

Upon request (after having received the first character) the measurement data are output via the interface. Important equipment parameters may also be set up via the interface.

When receiving messages through the interface, processing of commands entered via the keyboard may be delayed (up to 2 s max.). The instrument is controlled via the computer and when no transmission is in progress the instrument can be controlled via its keyboard. When wanting to disable the entry of parameters via the instrument's keyboard the LOCK[®]-function must be enabled.

Notes

After switching on the instrument, the interface will be set to the printer mode, i.e. it will output measurement data every 10 s without a further request to do so. Immediately after receiving the first character from a connected control computer the instrument will then change to the remote control mode.

For the transmission of data, only characters from the 7-bit ASCII code will be used.

When using a computer, this computer will require an input buffer size of at least 30 characters.

XON and XOFF handshaking is not used to control the data flow and will lead to error messages.

The RS 232 C interface requires at least 3 lines:

- Transmit line (TxD; Transmit data)
- Receive line (RxD; Receive data)
- Reference ground (GND; Signal ground)

The connections are made through a 9-way Sub-D connector (7/2).

3.2 Interface parameters

3.2.1 Baud rate

The baud rate is fixed to 2400 baud.

3.2.2 Data format

The data format is fixed to:

1 start bit, 7 data bits + 1 space, 1 stop bit.

A parity bit is not generated and no parity check is run on received data.

3.2.3 End and acknowledgement character for remote operation

The character <CR> (carriage return; ASCII code 13_d) is used as the end character for remote control operation in both directions.

After a A-series instrument has received a string of characters terminated by the end character <CR> it will respond by outputting the ASCII character <ACK> (acknowledge) or <NAK> (not acknowledge) depending on whether the instrument has sensed the command so that it can be carried out or not.

3.2.4 Output rate and end character for printer output

The output rate is fixed to 6 measurement data sets per minute, i.e. all measurement data or equipment status messages are transmitted at an interval of 10 s.

In the printer mode the characters <CR> <LF> (carriage return; ASCII code: 13_d and line feed; ASCII code: 10_d) are used.

3.3 Initial operation

3.3.1 Remote control operation

3.3.1.1 Cable link

In order to link the A-series instrument to a computer or terminal, a cable link has to be provided according to Section 3.8.

The A-series instrument requires at least 3 lines :

- Transmission data	TxD	Pin 2	Opposite side: Receive data
- Receive data	RxD	Pin 3	Opposite side: Transmission data
- Signal ground	GND	Pin 5	Opposite side: Signal ground

The signals DTR and RTS are generated by the A-series instrument in order to offer correct status conditions for the opposite side; the A-series instrument itself does not require these signals.

It is strongly recommended to use a screened interface cable, especially if there is the likelihood of electromagnetic interference. In this case the shield of the screened cable should only be connected on the side of the A-series instrument (Pin 9).

In the event of very high levels of electromagnetic interference and potential differences between the A-series instrument and the opposite side (also the sensor side) a potential equalization line of sufficient cross section should be connected between the various frame grounds (a 4 mm screw terminal is provided on the rear of each A-series instrument for this purpose).

Alternatively also RS 232 isolation amplifiers or fibre optical links may be used to prevent large equalization currents from flowing. Such equipment is commercially available.

3.3.1.2 Baud rate and data format

When starting up the instrument in connection with a computer or terminal the correct baud rate and data format must be set up on the connected equipment.

3.3.1.3 End character

In the remote control mode the characters <CR> (carriage return; ASCII code: 13_d) and line feed; ASCII code: 10_d) are used. The character <LF> (line feed; ASCII code: 10_d) is always ignored by the A-series instrument. With one exception each character string sent to the A-series instrument must be terminated with <CR>. The only exception is the reset command which consists only of one character <ESC> (see also Section 2.3.1.5).

In the other direction there is no exception; all characters transmitted by the A-series instrument in the remote control mode are terminated by <CR>.

In the case of a missing or incorrect end character <CR> the interface will usually not operate properly.

3.3.1.4 Acknowledgement character

In the remote control mode, the A-Series instrument will respond to each string it receives and which has been terminated by the end sign <CR>, with one of the ack-

nowledgement characters <ACK> or <NAK>.

<ACK> (ASCII code: 6_d) means that the received command has been detected, the parameters are acceptable and that the command which has been received can be run in the current operating mode.

<NAK> (ASCII code: 21_d) means that a variety of errors may have occurred during the transmission.

- General transmission fault, interference, wrong baud rate, wrong number of start, stop or data bits
- Wrong command or command can not be run at the moment (for example MIS instead of MES for request to send measurement data)
- Wrong direction command (R/W)
- Parameter not within the correct range, not permissible, incomplete, wrong number, not or incorrectly separated (: instead of ;)

It must always be taken in to account that the instrument will only be ready to receive and process the next command after receiving the <ACK> or <NAK> character and a possibly demanded reply character string.

Any characters which are sent to the instrument after the end sign and before the acknowledgement character is sent will be ignored.

Example for a CM 31

Communication where, for example, the measurement value is read from DM channel 1 followed by setting the PM channel to argon whereby one character is not transmitted correctly with subsequent correction by the control computer:

The control computer transmits „MES R TM 1 <CR>“
Time required for processing by the
A-series instrument

A-series instrument transmits „<ACK><CR>“
Time required for processing by the
A-series instrument

A-series instrument transmits
„TM1:MBAR :3.72E+01<CR>“

Control computer transmits
„GBS W PM1 ARGON<CR>“
Time required for processing by the
A-series instrument

A-series instrument transmits „<NAK><CR>“

Control computer transmits
„GBS W PM1 ARGON<CR>“
Time required for processing by the
A-series instrument

A-series instrument transmits „<ACK><CR>“

Note

The time required by the A-series instrument to process the interface commands may be as long as 500 ms, however, normally this time will be much shorter.

3.3.1.5 Reset character

With the character <ESC> (Escape; ASCII code: 27_d) without <CR> the interface of the A-series instrument may be reset to a defined state. A character string which is possibly still being processed is erased and processing of the command is terminated.

After receiving the <ESC> character this is acknowledged by <ACK> <CR>, after which the interface will be ready to receive again.

3.3.2 Printer operation

3.3.2.1 Output of measurement data to a printer

After start-up the A-series instrument will transmit all measurement data or the corresponding sensor status information automatically every 10 s.

A cable link according to Section 2.2 is required for the connection between the A-series instrument and a printer. The printer must have a RS 232 C interface which can be set up for the parameters required by the A-series instrument.

The A-Series instruments requires at least 2 lines:

- Transmission data TxD Pin 2 Opposite side
Receive data:
- Signal ground GND Pin 5 Opposite side:
Signal ground

3.3.2.2 RS 232 C baud rate and data format for printer output

Baud rate and data format are fixed (see Sections 3.2.1 and 3.2.2).

3.3.2.3 Output rate for printer output

The measurement data are output to a printer, for example, at a fixed interval (see Section 3.2.4).

3.3.2.4 End character

In the printer mode the character string <CR> <LF> (carriage return and line feed) is used as the end character (see Section 3.3.1.3).

3.4 Data output and data formats

3.4.1 Measurement data output

2.4.1.1 Remote control operation

The A-series instrument will transmit the measurement data after being requested to do so through the command „MES R measurement channel“

R Read (optional)
Measurement channel TM1, TM2, PM

Output in the following format, provided measurement operation is possible:

Measurement channel:Unit:-n.nnE-mm<CR>

Meaning:

Measurement channel	TM1, TM2, PM	3 characters
:Unit	mbar, Torr, Pa, Micron	7 characters
:-n.nn	Mantissa possibly with sign	6 characters
E-mm	Exponent always with sign	4 characters
<CR>	End character	1 character

Thus the entire length of a string for one set of measurement data is 21 characters.

Example TM1:MBAR :7.61E-01<CR>

Output when no measurements are possible

Status format:

Measurement channel:ErrorNo.:Errortext<CR>

Meaning:

Measurement channel TM1, TM2, PM

Error no.	Error text	Description
0	OFF	HV off (PM channel only)
1	FILBR	Filament broken (for TM channel and DM channel with series 300 THERMO-VAC sensor)
2		Not used
3	NOSEN	No sensor connected (for TM and DM channel)
4	FAIL	Sensor failure for DM channel or general unspecified fault

The length of the character string for the sensor status is also 21 characters.

Example TM1:3 :NOSEN<CR>

3.4.1.2 Printer output

In the „Print only“ mode the measurement data are output to the printer in the following format:

Output in the following format, provided measurement operation is possible:

Measurement channel:Unit:-n.nnE-mm<CR><LF>

Meaning:

Measurement channel TM1, TM2, PM 3 characters
 :Unit mbar, Torr, Pa, Micron 7 characters
 :-n.nn Mantissa possibly with sign 6 characters
 E-mm Exponent always with sign 4 characters
 <CR><LF> End character 2 characters

Thus the entire length of a string for one set of measurement data and for single-channel instruments is 22 characters.

Example

TM1:MBAR:4.04E+00
 TM2:MBAR:5.00E-04
 PM:MBAR:1.00E-05<CR><LF>

Output when no measurements are possible
Status format:

Measurement channel:ErrorNo.:Errortext<CR><LF>

Meaning:

Measurement channel TM1, TM2, PM

Error no.	Error text	Description
0	OFF	HV off (PM channel only)
1	FILBR	Filament broken (for TM channel and DM channel with series 300 THERMOVAC sensor)
2		Not used
3	NOSEN	No sensor connected (for TM and DM channel)
4	FAIL	Sensor failure for DM channel or general unspecified fault

Example

TM1:3 :NOSEN TM2:1 :FILBR PM1:0:OFF<CR><LF>

3.4.2 Parameter output and response time

The format for the response to requests for parameters is given in the list of programming commands in Section 3.5.

Parameter settings and requests for parameter and measurement data require internal processing so that response times up to 2 s max. are likely to occur.

When the A-series instrument is just processing a command or transmitting a string while further characters are being transmitted to the instrument it will ignore these as invalid.

3.5 Interface commands and data input for A-series instruments with RS 232 C interface

The interface commands are composed of the following sections:

- Command abbreviation 3 characters for example MES for measurement value (compulsory entry)
- Direction character 1 character R=Read or W=Write (can be omitted when the command only allows for writing or reading, respectively)
- Measurement channel 3 characters TM1, TM2, PM
- Separating character 1 character <,> (Comma; ASCII code: 44_d)
- Parameter value As many characters as necessary; possibly with further separating characters

Notes

Direction character:

W = Writing of parameters (write)

R = Reading of set parameters (read)

In the case of the programming commands for the instruments of the A-series spaces may be added at will or left out entirely.

All characters are accepted both in upper and lower case.

3.5.1 Formation of measurement data and readout commands

Selection of the type of gas

Select type of gas **GAS W** measurement channel, type of gas
 Read type of gas **GAS R** measurement channel
 Reply format: **GAS** measurement channel, type of gas
 Type of gas: N2 Nitrogen
 Ar Argon

Display; measurement channel assignment

Assignment of the measurement channel to the display **DSP W** measurement channel
 Reading of the assigned measurement channel **DSP R**

Reply format: DSP measurement channel

Note

When setting the measurement unit Micron all measurement value outputs and trigger setting values are basically in Micron; also in case of the PM-channel although the measurement value in the instrument's display is in Torr.

3.5.2 Trigger adjustment commands

Set individual triggers for the Level mode and the CE mode, if available.

TRG
 Enter trigger values TRG W measurement channel, p1, p2
 Range for p1: 1 or 2, corresponds to trigger 1 or trigger 2 of a measurement channel
 Range for p2: -n.nnE-mm
 Value for the trigger threshold within the range permissible for the corresponding sensor (see Operating Instructions of the corresponding instrument).
 Specifically:
 -n.nn Mantissa possibly with additional sign
 -mm Exponent always with sign

Note

- When changing the trigger mode, the trigger levels are set to their minimum values (see description for parameter page 1).
- When setting the trigger, rounding deviations of ± 0.1 of the mantissa may occur.

Read trigger levels TRG R measurement channel, p1
 Reply format TRG measurement channel, Trigger 1, 2 setted value

Set both triggers for Level, Interval, CI and CE mode.

TRC
 Enter trigger values TRC W measur. channel, p1, p2
 Range for p1, p2: p1 ≙ Trigger value for Trigger 1
 p2 ≙ Trigger value for Trigger 2
 Format: -n.nnE-mm
 Value for the trigger threshold within the range permissible for the corresponding sensor (see Technical Data „Thresholds“).
 Specifically:
 -n.nn Mantissa possibly with additional sign
 -mm Exponent always with sign

Example

TRC W TM1, 1.00, 2.00

3.5.3 Operating parameters

Entry of parameters via the keyboard

Enable parameter changes (equipment parameters may be changed via the keyboard) **LOK**
 LOK W OFF
 Disable parameter changes (equipment parameters can not be changed via the keyboard) **LOK**
 LOK W ON
 Read lock status **LOK**
 LOK R

Reading of measurement data

Read current measurement data **MES**
 MES R measurement channel
 (R = Read may be omitted, since only reading is possible)

Printer start

(Starting of printer output) **PRS**
 Printer output control PRS W or PRS

High voltage switching

Switching of the high voltage; only for the PM channel in the CM 33 **HVS**
 Switch high voltage off HVS Wchannel,OFF
 Switch high voltage on HVS W channel,ON
 Read high tension status HVS R measurement channel
 Reply format: HVS channel,OFF
 HVS channel,ON

3.6 Output of error messages

3.6.1 Interface errors (ERI)

Error messages which occur due to interface operating errors are transmitted upon request to the computer in the following format:

Error message request **ERI** R
 Reply Error message

Meaning of the error messages:

OK Last command was OK
 SYNERR p1 Syntax error with the meaning of p1
 1 = Receive buffer full
 2 = Command can not be interpreted; invalid
 PARERR p1 Parameter error with the meaning of p1
 3 = Measurement channel not permissible
 4 = Incorrect operating parameter
 5 = Read or write function not permissible

The stored interface error messages are erased as soon as the next interface command is received.

3.7 Program examples for setting the parameters

'Sample Remote Control Commands for A-series CM31 with RS232 Interface

```
CLS

'initialize constants
NAK$ = CHR$(21): ACK$ = CHR$(6)
'opening RS232 communication
OPEN "COM1:2400,N,8,1,rs,cs,ds,cd" FOR RANDOM AS #1

LOCATE 1, 1: PRINT "Sample Control Program for Leybold A-Series Gauge";
LOCATE 2, 1: PRINT "COMBIVAC CM31 with RS232-Interface";

' set display to PM measurement channel
PRINT #1, "dsp w pm1" ' command: set display to PM
LINE INPUT #1, AckNakTest$ ' get handshake character from CM31
DO ' start point of the never ending loop
CLS

' cold cathode high voltage on (to PM measurement channel)
PRINT #1, "HVs w pm1,On" ' send output command to CM31: PM high voltage on
LINE INPUT #1, AckNakTest$ ' get handshake character from CM31
IF AckNakTest$ <> ACK$ THEN ' test for <ACK>/<NAK> character
PRINT #1, "eri r" ' if <NAK>, then request CM31 error code
LINE INPUT #1, AckNakTest$ ' get handshake character (without test)
LINE INPUT #1, FailMessg$ ' get error code from CM31
LOCATE 4, 1: PRINT SPACE$(79); ' clear screen line
LOCATE 4, 1: PRINT "RS232 failure on cold cathode high voltage on command: ";
LOCATE 4, 40: PRINT FailMessg$; ' error code to screen
ELSE
LOCATE 4, 1: PRINT SPACE$(79); ' clear screen line
LOCATE 4, 1: PRINT "CM31 PM high voltage on successful";
END IF

' read cold cathode high voltage status (from CM31 PM measurement channel)
PRINT #1, "hVs R PM1" ' command: read cold cathode voltage status
LINE INPUT #1, AckNakTest$ ' get handshake character from CM31
IF AckNakTest$ <> ACK$ THEN ' test for <ACK>/<NAK> character
PRINT #1, "eri r" ' if <NAK>, then request CM31 error code
LINE INPUT #1, AckNakTest$ ' get handshake character (without test)
LINE INPUT #1, FailMessg$ ' get error code from CM31
LOCATE 5, 1: PRINT SPACE$(79); ' clear screen line
LOCATE 5, 1: PRINT "failure on reading HV status of PM channel: ";
LOCATE 5, 40: PRINT FailMessg$; ' error code to screen
ELSE
LINE INPUT #1, HvStatus$ ' if no failure then get HV status
LOCATE 5, 1: PRINT SPACE$(79); ' clear screen line
LOCATE 5, 1: PRINT "PM HV status: ";
LOCATE 5, 40: PRINT HvStatus$; ' PM HV status to screen
END IF
```

```

' take measurement value from CM31 PM cold cathode gauge channel
PRINT #1, "MESr pM1" ' command: read measurement value from CM31
LINE INPUT #1, AckNakTest$ ' get handshake character from CM31
IF AckNakTest$ <> ACK$ THEN ' test for <ACK>/<NAK> character
PRINT #1, "eri r" ' if <NAK>, then request CM31 error code
LINE INPUT #1, AckNakTest$ ' get handshake character (without test)
LINE INPUT #1, FailMessg$ ' get error code from CM31
LOCATE 7, 1: PRINT SPACE$(79); ' clear screen line
LOCATE 7, 1: PRINT "failure on reading PM measurement value: ";
LOCATE 7, 40: PRINT FailMessg$; ' error code to screen
ELSE
LINE INPUT #1, MeasVal$ ' if no failure then get measurement value
LOCATE 7, 1: PRINT SPACE$(79); ' clear screen line
LOCATE 7, 1: PRINT "actual PM measurement value: ";
LOCATE 7, 40: PRINT MeasVal$; ' output PM measurement value
END IF

' set gas type of PM channel to argon
PRINT #1, "GAS w pm1,ar" ' command: set PM gas type to argon on CM31
LINE INPUT #1, AckNakTest$ ' get handshake character from CM31
IF AckNakTest$ <> ACK$ THEN ' test for <ACK>/<NAK> character
PRINT #1, "eri r" ' if <NAK>, then request CM31 error code
LINE INPUT #1, AckNakTest$ ' get handshake character (without test)
LINE INPUT #1, FailMessg$ ' get error code from CM31
LOCATE 9, 1: PRINT SPACE$(79); ' clear screen line
LOCATE 9, 1: PRINT "failure on setting gas type argon: ";
LOCATE 9, 40: PRINT FailMessg$; ' error code to screen
ELSE
LOCATE 9, 1: PRINT SPACE$(79); ' clear screen line
LOCATE 9, 1: PRINT "setting gas type argon successful";
END IF

' read current gas type of CM31 PM (cold cathode channel)
PRINT #1, "GAS Rpm1" ' command: read current gas type of PM
LINE INPUT #1, AckNakTest$ ' get handshake character
IF AckNakTest$ <> ACK$ THEN ' test for <ACK>/<NAK> character
PRINT #1, "eri r" ' if <NAK>, then request CM31 error code
LINE INPUT #1, AckNakTest$ ' get handshake character (without test)
LINE INPUT #1, FailMessg$ ' get error code from CM31
LOCATE 10, 1: PRINT SPACE$(79); ' clear screen line
LOCATE 10, 1: PRINT "failure on reading PM gas type: ";
LOCATE 10, 40: PRINT FailMessg$; ' error code to screen
ELSE
LINE INPUT #1, GasType$ ' if no failure then get gas status
LOCATE 10, 1: PRINT SPACE$(79); ' clear screen line
LOCATE 10, 1: PRINT "current gas type of CM31 PM: ";
LOCATE 10, 40: PRINT GasType$; ' PM gas type to screen
END IF

' set display of CM31 to TM2
PRINT #1, "dsp w Tm2" ' command: set CM31 display to TM2 measurement channel
LINE INPUT #1, AckNakTest$ ' get handshake character from CM31
IF AckNakTest$ <> ACK$ THEN ' test for <ACK>/<NAK> character
PRINT #1, "eri r" ' if <NAK>, then request CM31 error code
LINE INPUT #1, AckNakTest$ ' get handshake character (without test)
LINE INPUT #1, FailMessg$ ' get error code from CM31
LOCATE 12, 1: PRINT SPACE$(79); ' clear screen line
LOCATE 12, 1: PRINT "failure on setting CM31 display to channel TM2 : ";
LOCATE 12, 40: PRINT FailMessg$; ' error code to screen

```

```

ELSE
LOCATE 12, 1: PRINT SPACE$(79);                                     ' clear screen line
LOCATE 12, 1: PRINT "setting CM31 display to channel TM2 successful";
END IF

'read current displayed measurement channel of CM31
PRINT #1, "dsp R"                                                 ' command: read CM31 display channel
LINE INPUT #1, AckNakTest$                                       ' get handshake character
IF AckNakTest$ <> ACK$ THEN                                       ' test for <ACK>/<NAK> character
PRINT #1, "eri r"                                               ' if <NAK>, then request CM31 error code
LINE INPUT #1, AckNakTest$                                       ' get handshake character (without test)
LINE INPUT #1, FailMessg$                                       ' get error code from CM31
LOCATE 13, 1: PRINT SPACE$(79);                                   ' clear screen line
LOCATE 13, 1: PRINT "failure on reading display setting of CM31: ";
LOCATE 13, 40: PRINT FailMessg$;                                 ' error code to screen
ELSE
LINE INPUT #1, DispSts$                                         ' if no failure then get display status
LOCATE 13, 1: PRINT SPACE$(79);                                   ' clear screen line
LOCATE 13, 1: PRINT "current displayed channel of CM31: ";
LOCATE 13, 40: PRINT DispSts$;                                  ' display status to screen
END IF

'setting CM31 trigger TM1 no. 1
PRINT #1, "TRG W TM1,1 , 12" command: send trigger value TM1 no.1 to CM31
LINE INPUT #1, AckNakTest$                                       ' get handshake character
IF AckNakTest$ <> ACK$ THEN                                       ' test for <ACK>/<NAK> character
PRINT #1, "eri r"                                               ' if <NAK>, then request CM31 error code
LINE INPUT #1, AckNakTest$                                       ' get handshake character (without test)
LINE INPUT #1, FailMessg$                                       ' get error code from CM31
LOCATE 15, 1: PRINT SPACE$(79);                                   ' clear screen line
LOCATE 15, 1: PRINT "failure on setting of TM1 no.1 trigger: ";
LOCATE 15, 40: PRINT FailMessg$;                                 ' error code to screen
ELSE
LOCATE 15, 1: PRINT SPACE$(79);                                   ' clear screen line
LOCATE 15, 1: PRINT "setting of CM31 trigger TM1 no. 1 successful ";
END IF

'reading of CM31 trigger TM1 no. 1 value
PRINT #1, "trg r tM1, 1"                                         ' command: reading of trigger TM1 no.1
LINE INPUT #1, AckNakTest$                                       ' get handshake character
IF AckNakTest$ <> ACK$ THEN                                       ' test for <ACK>/<NAK> character
PRINT #1, "eri r"                                               ' if <NAK>, then request CM31 error code
LINE INPUT #1, AckNakTest$                                       ' get handshake character (without test)
LINE INPUT #1, FailMessg$                                       ' get error code from CM31
LOCATE 16, 1: PRINT SPACE$(79);                                   ' clear screen line
LOCATE 16, 1: PRINT "failure on reading of trigger TM1 no. 1: ";
LOCATE 16, 40: PRINT FailMessg$;                                 ' error code to screen
ELSE
LINE INPUT #1, Trigger1$                                         ' if no failure then get trigger value 2
LOCATE 16, 1: PRINT SPACE$(79);                                   ' clear screen line
LOCATE 16, 1: PRINT "current trigger TM1 no. 1 value: ";
LOCATE 16, 40: PRINT Trigger1$;                                  ' trigger value TM1 no.1 to screen
END IF

'setting CM31 trigger PM no. 2
PRINT #1, "TRG w pm1,2 , 3.9E-7"
LINE INPUT #1, AckNakTest$
IF AckNakTest$ <> ACK$ THEN

```

```

PRINT #1, "eri r"
LINE INPUT #1, AckNakTest$
LINE INPUT #1, FailMessg$
LOCATE 18, 1: PRINT SPACE$(79);
LOCATE 18, 1: PRINT "failure on setting of trigger PM no. 2: ";
LOCATE 18, 40: PRINT FailMessg$;
ELSE
LOCATE 18, 1: PRINT SPACE$(79);
LOCATE 18, 1: PRINT "setting of CM31 trigger PM no. 2 successful ";
END IF

'reading of CM31 trigger PM no. 2 value
PRINT #1, "trg r PM1, 2"
LINE INPUT #1, AckNakTest$
IF AckNakTest$ <> ACK$ THEN
PRINT #1, "eri r"
LINE INPUT #1, AckNakTest$
LINE INPUT #1, FailMessg$
LOCATE 19, 1: PRINT SPACE$(79);
LOCATE 19, 1: PRINT "failure on reading of trigger PM no. 2: ";
LOCATE 19, 40: PRINT FailMessg$;
ELSE
LINE INPUT #1, Trigger2$
LOCATE 19, 1: PRINT SPACE$(79);
LOCATE 19, 1: PRINT "current trigger PM no. 2 value: ";
LOCATE 19, 40: PRINT Trigger2$;
END IF

'take measurement value from CM31 channel TM1
PRINT #1, "MESr Tm1"
LINE INPUT #1, AckNakTest$
IF AckNakTest$ <> ACK$ THEN
PRINT #1, "eri r"
LINE INPUT #1, AckNakTest$
LINE INPUT #1, FailMessg$
LOCATE 21, 1: PRINT SPACE$(79);
LOCATE 21, 1: PRINT "failure on reading TM1 measurement value: ";
LOCATE 21, 40: PRINT FailMessg$;
ELSE
LINE INPUT #1, MeasVal$
LOCATE 21, 1: PRINT SPACE$(79);
LOCATE 21, 1: PRINT "actual TM1 measurement value: ";
LOCATE 21, 40: PRINT MeasVal$;
END IF

'set display to PM measurement channel
PRINT #1, "dsp w pm1"
LINE INPUT #1, AckNakTest$

'cold cathode high voltage off (to PM measurement channel)
PRINT #1, "HVs w pm1,Off"
LINE INPUT #1, AckNakTest$

'set gas type of PM channel to nitrogen
PRINT #1, "GAS w pm1,n2"
LINE INPUT #1, AckNakTest$

LOOP
END

```

' if <NAK>, then request CM31 error code
' get handshake character (without test)
' get error code from CM31
' clear screen line
' error code to screen
' clear screen line
' command: reading of trigger value PM no.2
' get handshake character
' test for <ACK>/<NAK> character
' if <NAK>, then request CM31 error code
' get handshake character (without test)
' get error code from CM31
' clear screen line
' error code to screen
' if no failure then get trigger value PM no.2
' clear screen line
' trigger value to screen
' command: read measurement value from CM31 TM1
' get handshake character from CM31
' test for <ACK>/<NAK> character
' if <NAK>, then request CM31 error code
' get handshake character (without test)
' get error code from CM31
' clear screen line
' error code to screen
' if no failure then get measurement value
' clear screen line
' output measurement value
' command: set display to PM
' get handshake character from CM31
' send output command to CM31: PM high voltage off
' get handshake character from CM31
' command: set PM gas type to nitrogen on CM31
' get handshake character from CM31
' never ending loop from starts with DO near begin of this programm

3.8 Examples for the cable link between the interface and an IBM[®]-PC

Example for 9-way PC links

A-series instruments Remark for A-side	A-S- Desig.	A-S- Pin	PC- Pin	PC- Desig.	IBM-PC Remark for PC side
leave unconnected		1	1	DCD	possibly connect to 6
link	TxD	2	2	RxD	link
link	RxD	3	3	TXD	link
		4	4	DTR	
link	GND	5	5	GND	link
link	DTR	6	6	DSR	link
		7	7	RTS	
link	RTS	8	8	CTS	link
Shield	Shield	9	9	RI	possibly connect to 4

Example for 25-way PC links

A-series instruments Remark for A-side	A-S- Desig.	A-S- Pin	PC- Pin	PC- Desig.	IBM-PC Remark for PC side
leave unconnected		1	8	DCD	possibly connect to 6
link	TxD	2	3	RxD	link
link	RxD	3	2	TXD	link
		4	20	DTR	
link	GND	5	7	GND	link
link	DTR	6	6	DSR	link
		7	4	RTS	
link	RTS	8	5	CTS	link
Shield	Shield	9	22	RI	possibly connect to 20

Example for 25-way PC / modem links

A-series instruments Remark for A-side	A-S- Desig.	A-S- Pin	Modem- Pin	Modem- Desig.	Modem Remark for Modem Side	
leave unconnected		1	8	DCD	leave unconnected	Out
link	TxD	2	2	TxD	link	In
link	RxD	3	3	RXD	link	Out
		4	6	DSR		Out
link	GND	5	7	GND	link	--
link	DTR	6	20	DTR	link	In
		7	5	CTS		Out
link	RTS	8	4	RTS	link	In
Shield	Shield	9	22	RI	leave unconnected	Out

4 Maintenance

4.1 Service at LEYBOLD's

If you send an appliance to LEYBOLD indicate whether the appliance is free of substances damaging to health or whether it is contaminated. If it is contaminated also indicate the nature of hazard. To do so, you must use a preprinted form which we shall send to you upon request.

A copy of this form is printed at the end of the Operating Instructions: „Declaration of Contamination of Vacuum Equipment and Components“.

Either fasten this form at the appliance or simply enclose it to the appliance.

This declaration of contamination is necessary to comply with legal requirements and to protect our staff.

LEYBOLD must return any appliance without a declaration of contamination to the sender's address.

5 Brief operating instructions

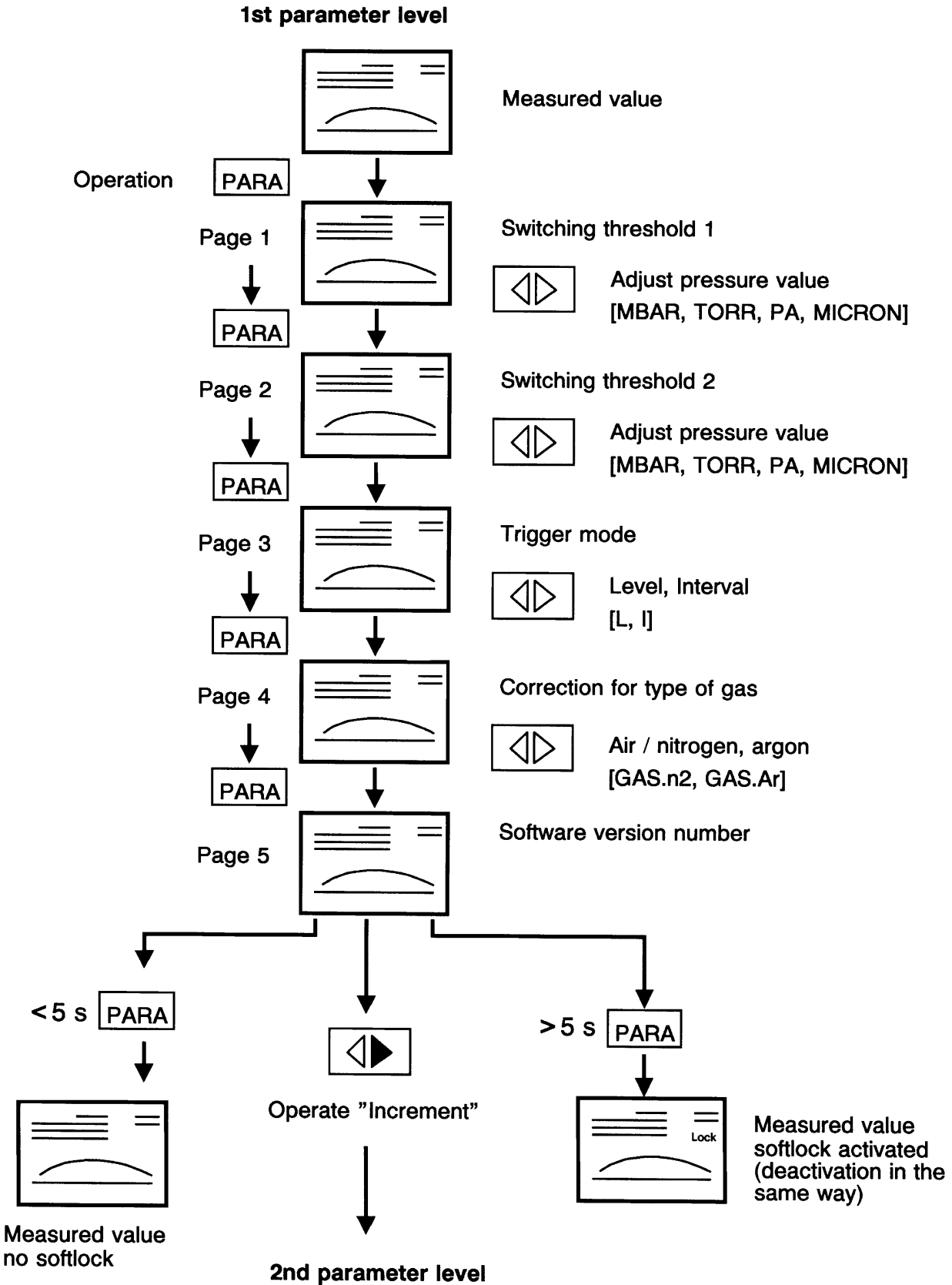

2nd parameter level

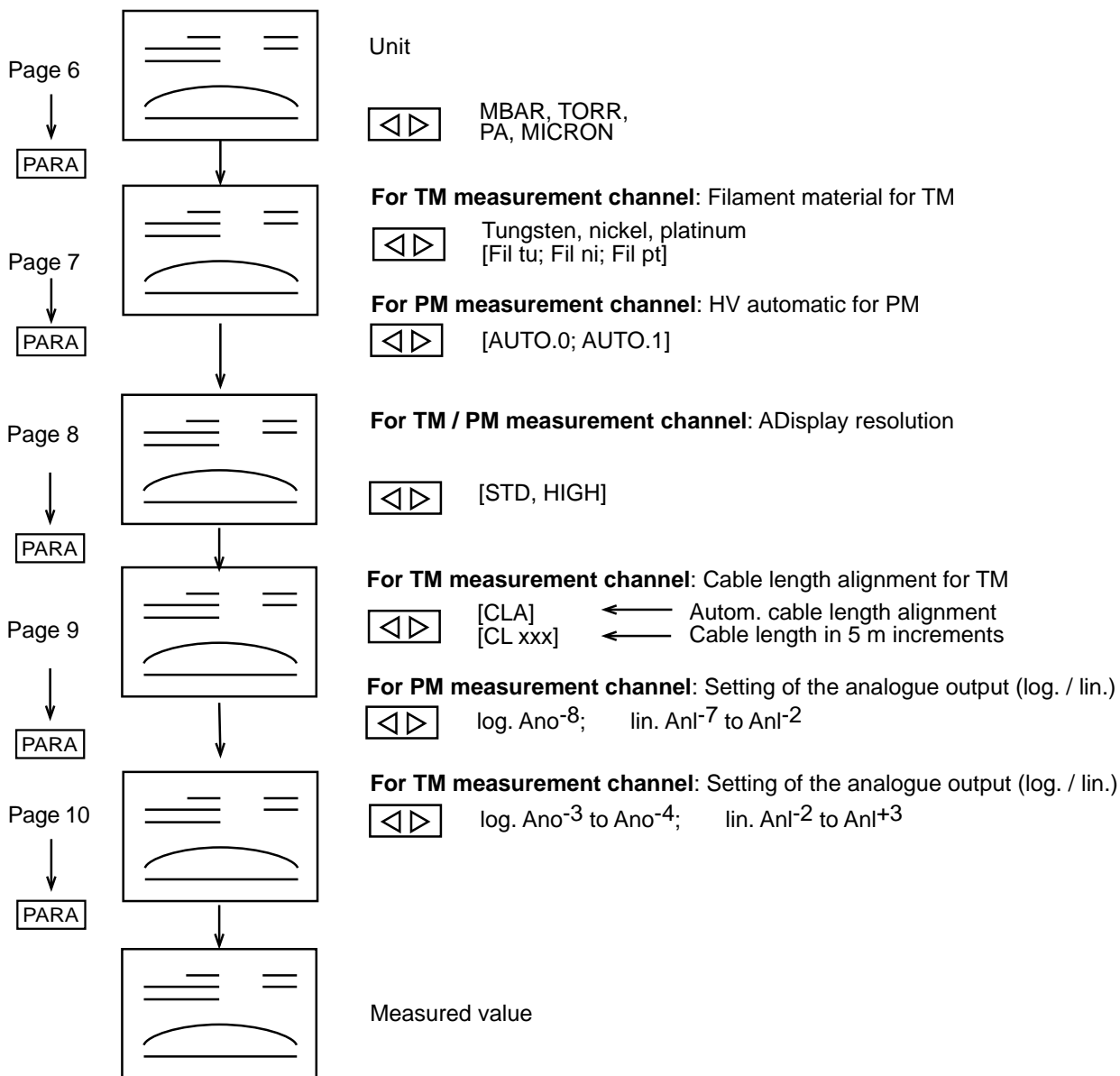



Declaration of Contamination of Vacuum Equipment and Components

The repair and/or service of vacuum equipment and components will only be carried out if a correctly completed declaration has been submitted. Non-completion will result in delay. The manufacturer could refuse to accept any equipment without a declaration.

This declaration can only be completed and signed by authorised and qualified staff.

Copies: Page 1 (white) to manufacturer or representative – Page 2 (yellow) attach to consignment packaging security – Page 3 (blue) copy for file of sender

1. Description of Vacuum Equipment and Components

– Equipment type/model: _____

– Code No.: _____

– Serial No.: _____

– Invoice No.: _____

– Delivery Date: _____

2. Reason for Return

3. Condition of the Vacuum Equipment and Components

– Has the equipment been used?
 yes no

– What type of pump oil/liquid was used? _____

– Is the equipment free from potentially harmful substances?

 yes (go to Section 5)

 no (go to Section 4)

4. Process related Contamination of Vacuum Equipment and Components

– toxic yes no

– corrosive yes no

– explosive yes no

– biological hazard yes no

– radioactive yes no

– other harmful substances yes no

Vacuum equipment and components which have been contaminated by biological explosive or radioactive substances, will not be accepted without written evidence of decontamination.

Please list all substances, gases and by-products which may have come into contact with the equipment:

Trade name Product name Manufacturer	Chemical name (or Symbol)	Dangerous material class	Measures if spillage	First aid in case of human contact
1.				
2.				
3.				
4.				
5.				

5. Legally Binding Declaration

I hereby declare that the information supplied on this form is complete and accurate. The despatch of the contaminated vacuum equipment and components will be in accordance with the appropriate regulations covering Packaging, Transportation and Labelling of Dangerous Substances.

Name of organisation or company: _____

Address: _____ Post code: _____

Tel.: _____

Fax: _____ Telex: _____

Name: _____

Job Title: _____

Date: _____ Company stamp: _____

Legally binding signature: _____



EEC Declaration of Conformity

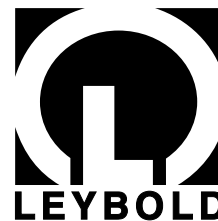

We - LEYBOLD AG - herewith declare that the products defined below meet the basic requirements regarding safety and health of the relevant EEC directives by design, type and the versions which are brought in to circulation by us.

In case of any products changes made without our approval, this declaration will be void.

Designation of the products:

COMBIVAC

Models:

CM 31 and CM 32

Catalogue numbers:

157 89, 896 89, 897 89
157 90

The product meets the requirements of the following directives:

- EEC Directive on Low-Voltages (73/23/EWG)

Cologne, February 14, 1995

Beeck, Business Area Manager
Vacuum Instruments

Cologne, February 14, 1995

Finke, Research and Development
Vacuum Instruments

LEYBOLD AG
Vacuum Technology
Bonner Strasse 498 (Bayenthal)
D-50968 Cologne
Tel.: + 49 (221) 347-0
Fax: + 49 (221) 347-1250

LHK.G1.0008.02.02.95

LEYBOLD AG

Vakuum

Bonner Straße 498 (Bayenthal)
D-50968 Köln

Telefon: (0221) 347-0

Telefax: (0221) 347-1250

1.80.5.676.30 RSP 09.95

Printed in Germany on chlorine-free bleached paper