



# Operation manual

## High-voltage power supply unit

Type: CARRERA

Serial no:

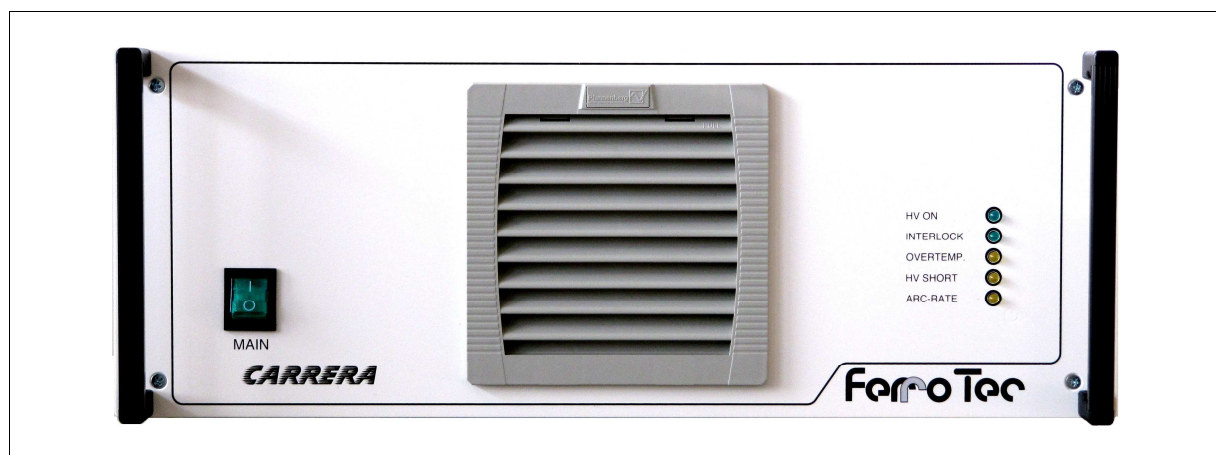



### FERROTEC GmbH

Postfach 33  
Seerosenstraße 1  
72669 Unterensingen

Telefon: +49 7022 - 9270-0  
Telefax: +49 7022 - 9270-10  
Internet: [www.ferrotec-europe.com](http://www.ferrotec-europe.com)  
E-Mail: [ebgun@de.ferrotec.com](mailto:ebgun@de.ferrotec.com)

Version 1.3\_15

Translation of the original Operation manual

		<b>NOTICE</b>
	<p><i>This instruction handbook is an integral part of the high voltage power supply and must be kept readily at hand for the operating personnel at all times.</i></p> <p><i>The safety instructions contained in it must be obeyed.</i></p> <p><i>If the machine is resold, the instruction handbook must always be delivered with it as well.</i></p>	

### **Liability**

The manufacturer's liability for the CARRERA power supply is based on the principles of German law.

The manufacturer accepts no liability for damage and losses due to:

- improper use;
- operation by unauthorised personnel;
- failure to follow safety regulations;
- failure to heed the information in the instruction handbook.

### **Translation**

If the machine is sold to a country in the EEA, this instruction handbook must be translated into the language of the country in which the machine is to be used.

Should the translated text be unclear, the original instruction handbook (German) must be consulted or the manufacturer contacted for clarification.

### **Copyright**

No part of this publication may be reproduced, transmitted, sold or disclosed without prior permission. Damages will be claimed for violations.

All rights reserved.

# 1 Table of Content

## 1.1 Table of content

1	Table of Content	2
1.1	Table of content	2
1.2	Table of pictures	4
1.3	Manufacturer's Declaration	5
2	Overview and Intended Use	6
2.1	Overview CARRERA-System	6
2.2	Intended Use	7
2.3	Explanation of terms	8
2.4	Technical specifications	9
2.4.1	Dimensions and weight	9
2.4.2	Specification	9
2.4.3	General specifications	9
3	Safety	10
3.1	Notes / Explanations	10
3.1.1	Explanation of used safety symbols	11
3.1.2	Machine Identification	12
3.2	Integrated Safety Systems	13
3.3	Overview of electrical connections	16
3.4	Safety Precautions (by the Operator)	17
3.5	Responsibilities of the Operator	19
3.6	Safety Inspections and Tests	22
4	General Warnings	23
4.1	Dangers	23
4.2	Operating Areas and Danger Zones at the Machines	24
4.3	Operating and Maintenance Personnel	25
4.4	Spare and Wearing parts	26
4.5	Shutdown Procedure	27
5	Installation	28
5.1	Delivery package	28
5.2	Transport and Packaging	29
5.2.1	Delivery (also for Spare and replacement Parts)	29
5.3	Intermediate Storage	30

5.4	Transportation to the point of Installation ( by Operator)	30
5.5	Assembly, Installation (only for trained personnel)	31
5.5.1	Assembly	31
5.5.2	Electric Connection	31
5.5.3	Overview of the electrical connectors and fuses	34
5.5.4	Connection of the high-voltage power supply unit	35
6	Functional description	39
6.1	Putting in operation for the first time (for specialized personnel only)	41
7	Operation	43
7.1	Operation and displaying elements	43
7.2	Operation modes	44
7.2.1	Operation	44
7.2.2	Switching on	44
7.2.3	Switching off	45
8	Cleaning/Maintenance	46
8.1	Complete Daily Cleaning	48
8.2	Cleaning	48
8.3	Maintenance	48
8.3.1	Function test plan	49
8.3.2	Inspections	49
8.4	Inspection of the machine	51
9	Troubleshooting	52
10	Emergency	53
11	Dismantling/Disposal	54
12	Appendix; Options	55
12.1	Appendix 1; Control unit GENIUS	55
12.2	Appendix 2; Filament Power Supply FPS	56

## 1.2 Table of pictures

Fig. 1	Overview CARRERA system	6
Fig. 2	Electrical connections of the high voltage power supply ( front side)	16
Fig. 3	Electrical connections of the high voltage power supply ( back side)	16
Fig. 4	Delivery package	28
Fig. 5	Wiring diagram of the CARRERA 3/5/6 high voltage power supply	33
Fig. 6	Wiring diagram of the CARRERA 10/12 high voltage power supply	33
Fig. 7	Overview of electrical connectors and fuses	34
Fig. 8	Interlock connector	37
Fig. 9	Harting plug, connector assignment of the power supply cable	38
Fig. 10	Overview high voltage power supply	39
Fig. 11	Overview of operation and display elements	43

1.3 Manufacturer's Declaration



## 2 Overview and Intended Use

### 2.1 Overview CARRERA-System

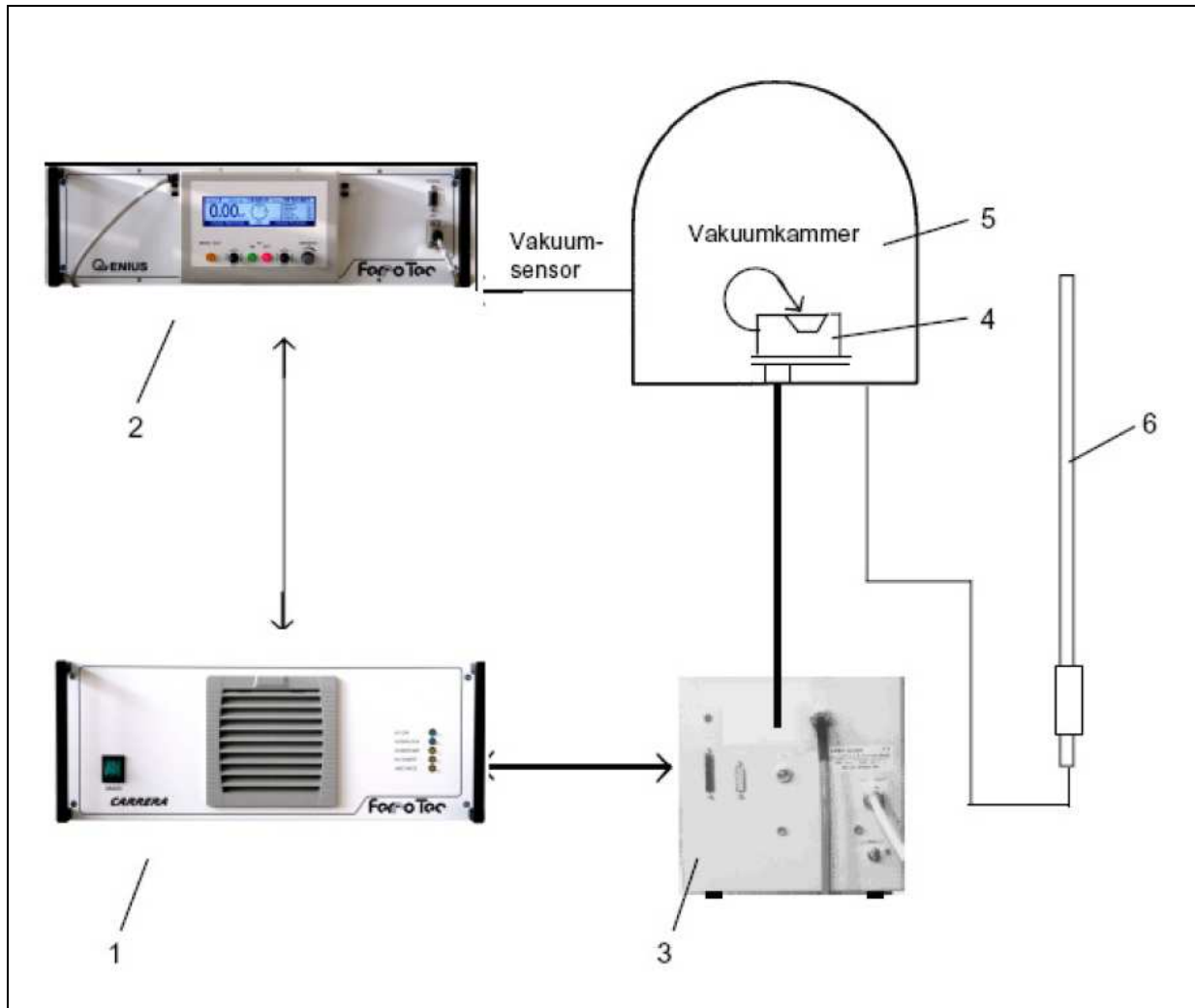

Fig. 1 Overview CARRERA system

**The complete evaporator package consist of the following:**

- 1 High voltage power supply HVP
- 2 Electron beam evaporator controller GENIUS with hand remote control
- 3 Filament power supply (FPS)
- 4 Electron beam evaporator
- 5 Vacuum chamber
- 6 Grounding rod

## 2.2 Intended Use

The high voltage power supply HVP is part of a group of devices for the operation of an electron beam evaporator installed in a vacuum chamber..

The group of devices consists of:



- High voltage power supply (HVP)
- Electron beam evaporator controller GENIUS with integrated remote control
- Filament power supply (FPS)
- Grounding rod

Use of the high voltage power supply for any other purpose requires the approval of the manufacturer.

The high voltage power supply HVP generates the high voltage needed to operate an electron beam evaporator. Other fields of application are only permitted with the written authorization of the manufacturer.



This operating manual deals solely with the design and operation of the high voltage power supply. Please see the relevant operating manuals for operation of the other devices in the group (see table of contents and figures, appendices 1 + 2).

These devices were developed, designed and built solely for commercial/industrial use.

	 <b>DANGER</b>
	<p><i>The high voltage power supply HVP is intended solely for the purpose described above. Any other use or modification of the high voltage power supply HVP without the written consent of the manufacturer is deemed improper. The manufacturer accepts no liability for resultant damage. The risk is borne solely by the operator.</i></p> <p><i>The high voltage power supply HVP may only be put into operation when it has been ensured that all safety equipment is operative and the total installation of the vacuum system comply with EU directives.</i></p>



Proper use of the machine in accordance with its intended use includes compliance with the manufacturer's operating, maintenance and repair instructions. The use is restricted to rooms in a building or halls.

		<b>HINWEIS</b>
	<p><b>Notice on application of the EMC Directive 2004/108/EC in the manufacturer's declaration:</b> <i>The high voltage power supply HVP is only allowed to be operated in <b>Industrial environment</b>.</i></p>	

### 2.3 Explanation of terms

- HVP - High voltage power supply unit
- GENIUS - Electron beam evaporation controller
- FPS - Filament Power Supply

## 2.4 Technical specifications

### 2.4.1 Dimensions and weight

Width:	483 mm
Height ( 3, 5 und 6 kW units):	175 mm
Height (10 und 12 kW units):	350 mm
Depth:	550 mm
Weight:	approx. 28,5 kg

### 2.4.2 Specification

Power:	3 kW	5 kW	6 kW	10 kW	12 kW
Mains power supply:	<b>EU Version:</b> 3 x 400V +/-10 %  <b>US Version:</b> 3 x 208V +/-10 %	<b>EU Version:</b> 3 x 400V +/-10 %  <b>US Version:</b> 3 x 208V +/-10 %	<b>EU Version:</b> 3 x 400V +/-10 %  <b>US Version:</b> 3 x 208V +/-10 %	<b>EU Version:</b> 2X 3 x 400V +/-10 %  <b>US Version:</b> 2X 3 x 208V +/-10 %	<b>EU Version:</b> 2X3 x 400V +/-10 %  <b>US Version:</b> 2X3 x 208V +/-10 %
Frequency:	50/60 Hz	50/60 Hz	50/60 Hz	50/60 Hz	50/60 Hz
Control Volage:	4 - 10 kV	4 - 10 kV	4 - 10 kV	4 - 10 kV	4 - 10 kV
High voltage set point:	4 bis 10 V, DC (entspr. 4 - 10 kV)	4 bis 10 V, DC (entspr. 4 - 10 kV)	4 bis 10 V, DC (entspr. 4 - 10 kV)	4 bis 10 V, DC (entspr. 4 - 10 kV)	4 bis 10 V, DC (entspr. 4 - 10 kV)
Emission current:	0 -300 mA	0 - 500 mA	0 - 600 mA	1.000 mA	1.200 mA
Emission current actual valuet:	0 -10 V, DC (0 -300 mA)	(0 - 500 mA)	(0 - 600 mA)	(0-1000 mA)	(0-1.200 mA)
Electrical connection: (see chap.5.5.2)	EU Version : 3 x 16 A slow blow US Version: 3 x 25 A slow blow	EU Version : 3 x 16 A slow blow US Version: 3 x 25 A slow blow	EU Version : 3 x 16 A slow blow US Version: 3 x 25 A slow blow	EU Version : 2X3 x 16 A slow blow US Version: 2X3 x 25 A slow blow	EU Version : 2X3 x 16 A slow blow US Version: 2X3 x 25 A slow blow

### 2.4.3 General specifications

**Ambient temperature :**

Lower limit:	-10 bis 35 °C
Upper limit :	+ 40° C
Air humidity max:	65 %

Noise level:	L <sub>PA</sub> = < 70 dB (A)
--------------	-------------------------------

**3 Safety**

**3.1 Notes / Explanations**

		<b>DANGER</b>
	<p><i>“DANGER” warns of dangerous situations. Avoid these dangerous situations! Otherwise they could result in severe injury or death.</i></p>	

		<b>WARNING</b>
	<p><i>“WARNING” warns of dangerous situations. Avoid these dangerous situations! Otherwise they could result in severe injury or death.</i></p>	















		<b>CAUTION</b>
	<p><i>“CAUTION” in connection with this warning symbol warns of dangerous situations. Avoid these dangerous situations! Otherwise they could result in severe injury or death.</i></p>	

		<b>NOTICE</b>
	<p><i>“NOTICE” gives you recommendations for action, and there is no risk of injury if you fail to comply with them. However, follow these recommendations for action to avoid damage and annoyance.</i></p>	

		<b>NOTICE</b>
	<p><b>Instruction manual mandatory;</b> <i>framed and marked with a book symbol.</i></p>	

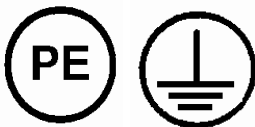
		<b>NOTICE</b>
	<p><b>„NOTICE“</b> are marked with the word "NOTICE" . This informs you about further literature.</p>	

### 3.1.1 Explanation of used safety symbols

	 <p style="text-align: center;"><b>DANGER</b></p> <p><b>Danger from electric current</b> framed and marked with the symbol shown opposite.</p>
	 <p style="text-align: center;"><b>DANGER</b></p> <p><b>Danger of burns</b> framed and marked with the symbol shown opposite.</p>
	 <p style="text-align: center;"><b>DANGER</b></p> <p><b>Danger of your hands being crushed or injured</b> framed and marked with the symbol shown opposite.</p>
	 <p style="text-align: center;"><b>DANGER</b></p> <p><b>Danger from magnetism</b> framed and marked with the symbol shown opposite.</p>
	 <p style="text-align: center;"><b>DANGER</b></p> <p><b>Danger for people with cardiac pacemakers (and with insulin pumps and people with active or passive prostheses and ferromagnetic or conductive foreign bodies) are marked with the symbol shown opposite.</b></p>
	 <p style="text-align: center;"><b>NOTICE</b></p> <p><b>Protective conductor connection</b> marked at the connection points by the symbol shown opposite.</p>
	 <p style="text-align: center;"><b>NOTICE</b></p> <p><b>Environment sign</b> marks actions to protect the environment.</p>

### 3.1.2 Machine Identification

#### **Serial-Nummber**

The information in this instruction handbook only applies to the High voltrage power supply whose type designations are given on the title page

The identification plate including the serial number is attached on the back of the high voltage power supply.

It is important that the type designation and the serial number is stated correctly when consulting us.

We can only process your query properly and quickly if this information is correct.

### 3.2 Integrated Safety Systems

The integrated safety systems must be checked at regular intervals (**d**= daily, **w** = weekly, **m** = monthly,  $\frac{1}{2}$  **y** = half-yearly, **y** = yearly).

The test methods that are to be applied are:

**V** = visual inspection, **F** = function test, **M** = measurement.

**The operator must implement the following in the overall plant:**

#### Mains Isolator (Main Switch)

The high voltage power supply is connected to the main power supply system. The electron beam evaporator is connected to and disconnected from the power supply with the main switch for this power supply system.

Test	
Interval	Method
<b>y</b>	<b>F</b>

		DANGER
	<p><i>When the main switch is switched off for cleaning, maintenance and repair work, it must be locked with a padlock to prevent unauthorised switching on.</i></p>	

#### Emergency Stop System

The high voltage power supply has to be integrated in a master emergency stop system that immediately puts the high voltage power supply into a safe operating state when actuated.

Test	
Interval	Method
<b>m</b>	<b>F</b>

#### Safety System

- Discharge rod,
- Safety switch at the vacuum chamber for the evaporator,
- Safety latch for interlocks
- Flow controller
- Vacuum monitor,

Test	
Interval	Method
<b>m</b>	<b>F</b>

- Stop valve for the cooling water supply.

**Internal Interlock circuit**

Using the plug X304 the CARRERA high voltage power supply has to be integrated into the emergency shut off circuit of the complete vacuum system

Test	
Interval	Method
m	F

**Machine Control System**

The machine control system has to be equipped internally with a three-phase, five-wire supply system with current-carrying mid-point conductor and **separate ground conductor** (with YELLOW/GREEN insulation).

Test	
Interval	Method
y	V, F, M

		DANGER
	<p><i>The owner is required to ensure that the unauthorized persons ( i.e., who are not operating or maintenance personnel) are prevented from entering the operating area.</i></p>	

The operating and maintenance personnel are trained in the use of the machine at its point of installation by personnel from FERROTEC GmbH. Should you have any questions or be uncertain about anything, please contact FERROTEC GmbH.

		NOTICE
	<p><i>It is strictly forbidden to render any of the safety systems inoperative or to modify their action.</i></p>	

		NOTICE
	<p><i>This instruction handbook is an integral part of the electron beam evaporator and must be kept readily at hand for the operating personnel at all times. The safety instructions contained in it must be obeyed.. If the electron beam evaporator is resold, the instruction handbook must always be delivered with it as well.</i></p>	



**NOTICE**

*The type, scope and action of the safety systems were arranged with the operator.*



### 3.3 Overview of electrical connections

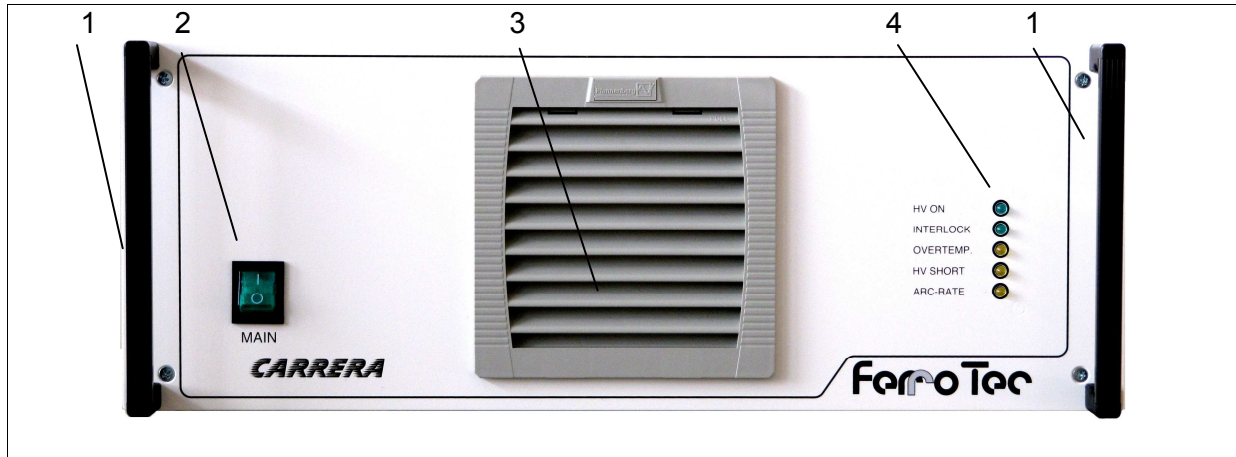

Fig. 2 Electrical connections of the high voltage power supply ( front side)

#### Front side of the high voltage power supply:

- 1 Transportation handle
- 2 ON/OFF switch
- 3 Air filter inlet
- 4 LED-Display

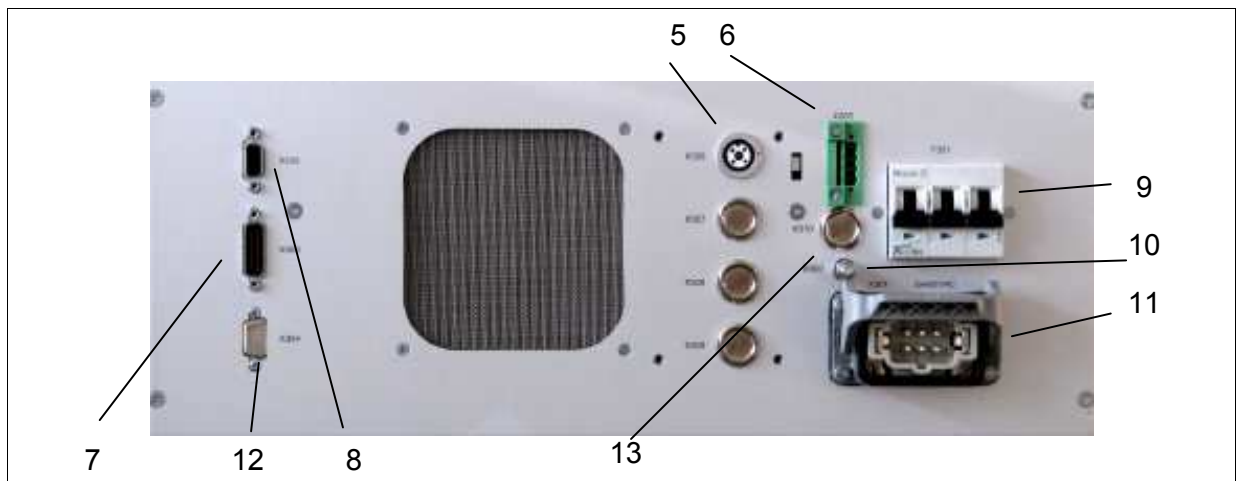

Fig. 3 Electrical connections of the high voltage power supply ( back side)

#### Back side of the high voltage power supply:

- 5 High voltage output
- 6 Interlock connection
- 7 Digital interface (connection to Control unit)
- 8 Analoginterface (connection to Control unit)
- 9 Fuses
- 10 Grounding

- 11 Mains supply
- 12 Connection Master/Slave: Control signal
- 13 Connection Master/Slave: Interlock signal

### 3.4 Safety Precautions (by the Operator)

The operator must:

- instruct his operating and maintenance personnel in the use of the **safeguards** of the electron beam evaporator and
- ensure the safety precautions are being observed including the use of personal protective equipment.
- The owner must ensure that entry to the hazard area of the machine (into which the high voltage power supply has been built) by unauthorized persons (no operating and maintenance personnel) is prevented. The minimum clearances stated in DIN EN ISO 13857 are to be complied with when installing the high voltage power supply.
- The high voltage power supply may only be operated when the safety devices of the machine into which the high voltage power supply has been built have been activated. The person setting up the entire machine must ensure that through suitable technical measures.
- The cutting off of the energy sources is to be done in such a way technically that the switching-off procedure described under section 4.5 can be complied with.

This instruction handbook must be kept in a safe place for future reference. The frequency of inspections and checks must be observed.

The work described in this instruction handbook is explained in such a way that

- the chapters on operation and modes of operation can be understood by an **instructed person** and
- those on transport, installation and assembly, maintenance and troubleshooting by a **skilled person**.

The chapters on **transport, installation and assembly, maintenance and troubleshooting** are intended for **skilled persons only**. Work described in these chapters may only be carried out by such skilled persons.

**Instructed Person**



A person familiarised with and, if applicable, trained in his or her particular duties by a skilled person and advised of the risks of improper conduct and about the necessary safeguards and safety precautions.

**Skilled Person**

A person with relevant technical training, know-how, experience and knowledge of applicable standards to enable him or her to assess the work assigned to him or her and to perceive potential risks.

**Definitions based on EN 60204-1:2006**

### 3.5 Responsibilities of the Operator

		<b>NOTICE</b>
	<p><i>In the EEA (European Economic Area) national implementation of the framework directive 89/391/EEC and corresponding individual directives, in particular the directive 2009/104/EEC concerning the minimum safety and health requirements for the use of work equipment by workers at work, as amended, are to be observed and adhered to. In Germany the Plant Safety Ordinance of October 2002 must be observed (translation of the above-mentioned directive into national law).</i></p>	

The operator must (where necessary) obtain any local **operating permits** required and observe the provisions contained therein

In addition to this he must observe local laws and regulations on

- personnel safety (accident prevention regulations)
- safety of work materials and tools (safety equipment and maintenance)
- disposal of products (laws on wastes)
- disposal of materials (laws on wastes)
- cleaning (cleaning agents and disposal)
- environmental protection.

In addition, the owner must note:



- A constant hazard evaluation of the workplaces (danger of hands being crushed, danger of stumbling) is to be carried out. The measures are to be defined in work instructions and the working personnel are to be instructed accordingly
- The supervisors must check compliance with the measures stated in the work instructions.
- Ensure that the operating personnel are suitably trained.
- Work on electrical equipment is only to be carried out by suitably trained persons. The connecting cables and terminals must be properly insulated and covered.
- It is only possible to ensure optimal functioning of the elements if the machine controller is working perfectly. The switching states of the limit switches must be properly incorporated into the machine controller and the signal cables must be in perfect condition.



- The switching and safety facilities for setting up, testing, shutting down (including shutting down in an emergency), operation, maintenance, cleaning and servicing are to be installed and verified by the person setting up the entire unit. This includes also lockable main switches and emergency shut off switches
- The owner must ensure that the operating stations are not affected by waste gases (such as diesel engine exhaust fumes) or a lack of oxygen.
- The workplaces are to be assessed by the owner in accordance with the noise and vibration regulations. Any noisy areas are to be marked, the employees are to be instructed about them and must use hearing protection.
- The owner is required to provide suitable safety measures for protection against fire such as suitable fire extinguishers of the stipulated number and size at easily accessible points and is to instruct his employees about protection against fire
- The warning notes from the documentation for modules supplied by other companies are to be complied with and integrated into the workplace-related hazard evaluations
- The operator is required to ensure that the high voltage power supply is only operated when it is in perfect working order



**Connections:**

Before starting the high voltage power supply the operator must ensure that:

- only specifically trained personnel are used for installation and start-up if this work is done by the operator himself and that local rules and laws are followed in the way this is installed..

		<b>NOTICE</b>
	<p><b>Lighting</b> <i>The operator must ensure that there is adequate and uniform lighting in all areas of use of the electron beam evaporator. The recommended illumination is 300 Lux (maintenance value; ASR 7/3 applies in Germany).</i></p>	

		<b>NOTICE</b>
	<p>The owner envisages <b>only one</b> earth circuit connector on the floor of the vacuum chamber. All the devices (Carrera, GENIUS, FPS, and grounding rod) are to be connected in star form from this earthing point. Use the grounding points that have been provided at the individual devices for this purpose. The earth circuit connector itself must be earthed at the earthing point of the building.</p> <p>The guarantee is null and void if the installation is not carried out correctly.</p>	

		<b>NOTICE</b>
	<p>The owner envisages phase monitoring for the HVP. The phase monitoring system must cut the HVP off from the mains if a mains phase fails.</p>	

### 3.6 Safety Inspections and Tests

Factory inspections and tests by the manufacturer.

1. Airborne noise measurement
  - According to the Machinery Directive (Position 1.7.4/f)
  
2. Tests and inspections in terms of DIN EN 60204-1 (Edition 2007)
  - Check whether the electrical equipment corresponds to the technical documentation (chap. 18.1)
  
  - Continuous connection of the protective conductor system (chap. 18.2)
  
  - Insulation resistance tests (chap. 18.3)
  
  - Voltage tests (chap. 18.4)
  
  - Protection against residual voltage (chap. 18.5)
  
  - Function tests (chap. 18.6)  
The functions of the electrical equipment, particularly those concerning safety and protective measures, were tested







## 4 General Warnings

### 4.1 Dangers

The safety systems and safety instructions described in this handbook must be heeded accordingly.

The machine is operated from the control unit in combination with the GENIUS controller, the CARRERA high voltage power supply and the overall plant.

Note that a fan is built into the high-voltage mains device. Ensure that there is clear space of 20 cm before and in front of the unit to ensure a free and continuous flow of air.



	 <p style="text-align: center;"><b>DANGER</b></p> <p><i>Pay attention to the <b>danger of electric shock</b> when carrying out adjustment, maintenance and repair work! Before touching the electron beam evaporator, discharge it with the <b>grounding rod</b>.</i></p>
	 <p style="text-align: center;"><b>DANGER</b></p> <p><i>There is a <b>danger of burns</b> at heated parts, especially at the crucible. Wear suitable protective gloves.</i></p>
 	 <p style="text-align: center;"><b>DANGER</b></p> <p><i>Pay attention to the <b>dangers from magnetism</b> when using and handling the electron beam evaporator.</i></p> <p><i>People with cardiac pacemakers (and with insulin pumps and people with active or passive prostheses and ferromagnetic or conductive foreign bodies) must keep clear of the electron beam evaporator! The limits of how close they may approach the machine must be clearly marked.</i></p>



#### 4.2 Operating Areas and Danger Zones at the Machines

The **operating area** is defined by the operator (overall plant).

The **danger zone** during adjustment and maintenance work is the immediate area around the high voltage power supply.

	 <b>WARNING</b>
	<p><i>The danger zone during adjustment, maintenance and repair work extends 1 m around the electron beam evaporator. The area needed to open the switch cabinet doors must be taken into account.</i></p> <p><i>Keep the danger zone around the machine free of objects. Lay cables in such a way that they cannot be tripped over!</i></p> <p><i>The operator must ensure that access to the <b>danger zones</b> by unauthorised persons is prevented..</i></p>

The danger zones may only be entered for cleaning, maintenance and repair work by skilled personnel under compliance with applicable safety regulations.



### 4.3 Operating and Maintenance Personnel

The operating and maintenance personnel are those people responsible for the transport, assembly, installation, operation, adjustment and cleaning of the machine as well as for troubleshooting.



1. The machine may only be operated by trained and authorised personnel.
2. The different responsibilities in the operation of the machine must be clearly defined and observed so that no confusion with respect to responsibilities arises, thus endangering safety.
3. Whenever any work (operation, maintenance, repair, etc.) is carried out, the shutdown procedure specified in this instruction handbook must be followed.
4. The operating personnel may not apply any working methods that impair the safety of the machine.
5. The operating personnel are co-responsible for ensuring that no unauthorised person works with or on the machine
6. The operating personnel must immediately report any changes in the machine that impair its safety to the responsible executive.
7. The unit may only be operated when it is in perfect working order.
8. The operating personnel are to be equipped by the owner with safety equipment as required by law and appropriate for the materials being processed.
9. The owner is required to regularly check that the personal safety equipment is actually being used.





#### 4.4 Spare and Wearing parts

Spare parts and accessories that have not been supplied by us have also not been tested and approved by us. The fitting and/or use of such products could therefore negatively affect the design characteristics of your machine. FERROTEC GmbH accepts no liability for damages arising from the use of non-original parts and non-original accessories.

		<b>DANGER</b>
	<p><i>Fundamentally speaking, it is forbidden to make any repairs within the unit.</i></p> <p><b><i>Danger: high voltages!</i></b></p>	

#### 4.5 Shutdown Procedure

	 <b>NOTICE</b>
	<p>The shutdown procedure may only be initiated by skilled personnel according to the definition in DIN EN 60 204 (see also chap. 3.5).</p>

   	 <b>DANGER</b>
	<p>The following procedure for switching off is to be followed without fail before carrying out any cleaning, repair or maintenance work.</p> <p>1. Switch off the unit:</p> <ul style="list-style-type: none"><li>- Switch off the high voltage with the HV button at the GENIUS.</li><li>- Turn off the On/Off switch at the HVP high-voltage mains device.</li><li>- Pull out the mains plugs at the high-voltage mains device X301, control X101 and the filament current supply X201.</li><li>- Wait for at least 3 minutes before starting work on the electrical equipment. The capacitors must discharge themselves.</li></ul> <p>2. For maintenance and repair work:</p> <ul style="list-style-type: none"><li>- Ensure that nothing is still electrically live,</li><li>- Use an earthing rod to earth all the high-voltage feedthroughs.</li></ul> <p>There is a danger to life and limb for the personnel if this procedure is not followed.</p>

## 5 Installation

### 5.1 Delivery package

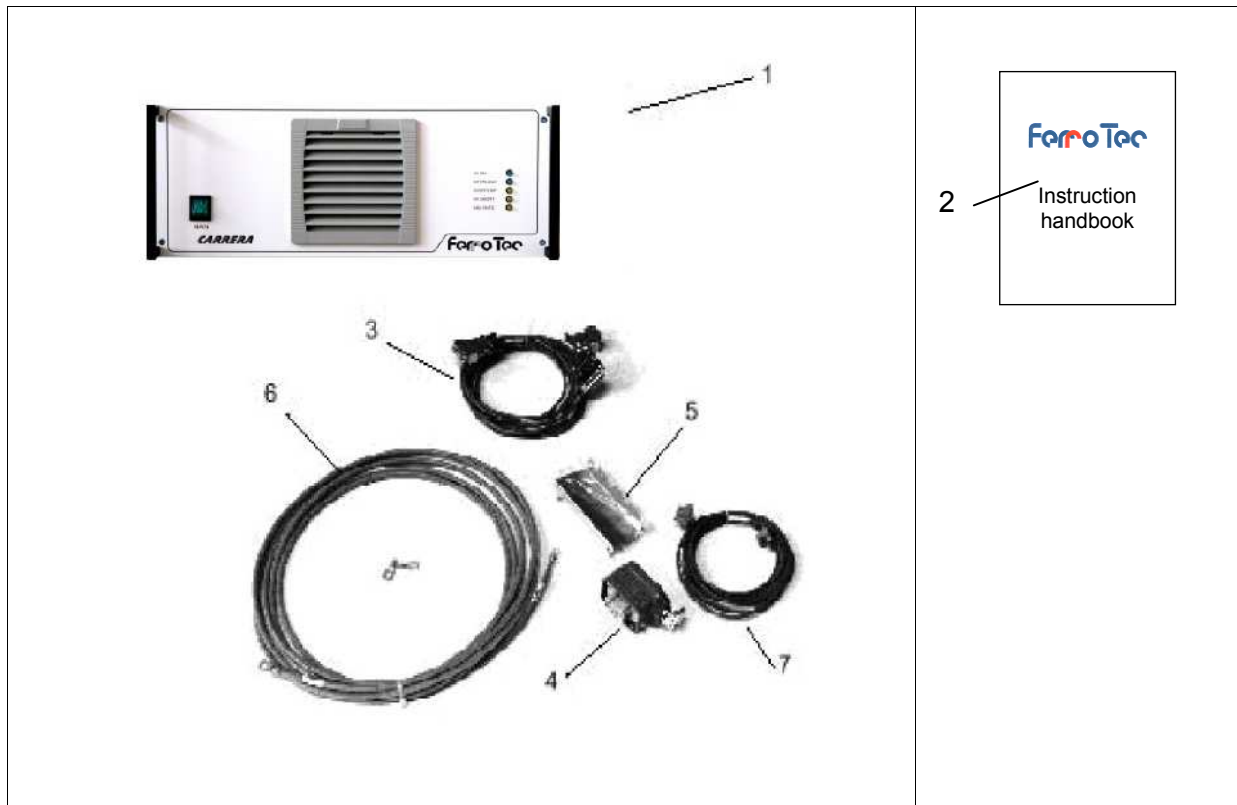

Fig. 4 Delivery package

**The delivery package consists of:**

- 1 High voltage power supply HVP
- 2 Instruction handbook
- 3 Y-Kabel (see Fig. 5-2) Nr. 950040
- 4 Harting plug and accessory
- 5 Interlock with 3 Allen screws M4-10 mm
- 6 Grounding cable (see Fig. 5-2) P/N. 950001
- 7 Interlock cable (see Fig. 5-2) P/N 950010

## 5.2 Transport and Packaging

Machines, devices and other equipment from FERROTEC GmbH are carefully inspected and packed before shipment. Nevertheless, it is still possible that they might become damaged during transit

### 5.2.1 Delivery (also for Spare and replacement Parts)

#### **Receiving Inspection:**

- Check the shipment against the packing list to ensure that it is complete!

#### **If the Packaging is Damaged**

- Check the shipment itself for damage (visual inspection)!

#### **Complaints**

If the shipment was damaged during transit:

- Immediately contact the last carrier!
- Keep the packaging material (for possible inspection or return shipment)



### 5.3 Intermediate Storage

The freight packaging of the electron beam evaporator and spare and replacement parts is designed for a storage period of three months from delivery.



#### Storage Conditions

Closed and dry room with a room temperature of +5°C to +40°C.  
The relative humidity allowed is max 80%  
(not condensing).

### 5.4 Transportation to the point of Installation ( by Operator)

		<b>WARNING</b>
	<i>Take the <b>weight</b> of the <b>transport unit</b> into account during transport (see technical specifications). The transport unit can tip over during transport. Pay attention to the <b>centre of gravity</b></i>	

After unpacking the high-voltage mains unit, transport it to the intended place of installation with suitable lifting gear or else transport it with two people.

		<b>NOTICE</b>
	<i>The weight of the high voltage power supply is approx. 28,5 kg.</i>	

Two handles are provided at the front of the unit to enable it to be held.

### 5.5 Assembly, Installation (only for trained personnel)

Assembly and initial start-up must be carried out by skilled personnel from FERROTEC GmbH or the customer's skilled personnel who have been especially trained for this work.

Consult the instruction handbook and technical reference material supplied for assembly and installation of the electron beam evaporator.

		<b>DANGER</b>
	<i>The installation of the high voltage power supply must be carried out only by trained, skilled personnel.</i>	

#### 5.5.1 Assembly

- The high voltage power supply is designed to be mounted into a 19"-Rack.
- Please, keep in mind that the unit must be installed in such a way that there is unobstructed air inlet and outlet for the operation of the fan of the high-voltage power supply unit

		<b>NOTICE</b>
	<i>Check the load-bearing capacity of the assembly rack. To keep the point of gravity of the whole assembly as low as possible, it is recommended to install the high-voltage power supply unit as the lowest device of the group.</i>	

#### 5.5.2 Electric Connection

##### Connection conditions

- Connect the power supply line to the Harting plug in accordance with the supplied drawing (see Appendix).
- Observe the prescribed safety earthing connections
- Make sure there is a differential current switch.



- Connect the filament power supply to the emergency switching system of the whole equipment.

		<b>DANGER</b>
	<p><i>Please, note that before the connection of the high-voltage power supply unit the complete cabling of the vacuum system, the electron beam vaporizer, the filament power supply and the Genius control unit must be installed.</i></p>	

**Wiring diagram** (with an electron beam vaporizer) and the GENIUS control unit.

		<b>NOTICE</b>
	<p><i>On special versions the wiring diagram attached in the Appendix is valid in these case of these designs.</i></p> <p><i>If the Genius control unit is used the wiring diagram shown in this operation manual is valid.</i></p>	

The wiring diagram contains all connections.  
The plugs are marked with X...; you will find this marking on the devices as well. The marking of the cables is 95 .. .. At the same time these are part numbers for ordering spare parts.

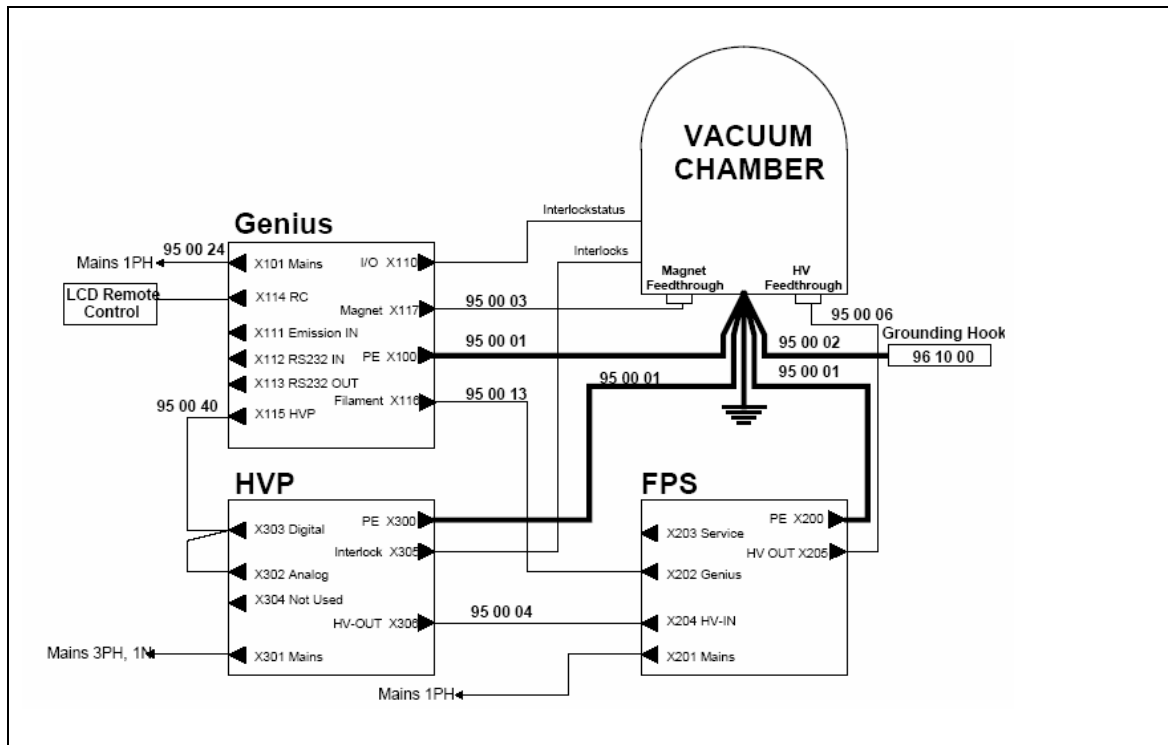

Fig. 5 Wiring diagram of the CARRERA 3/5/6 high voltage power supply

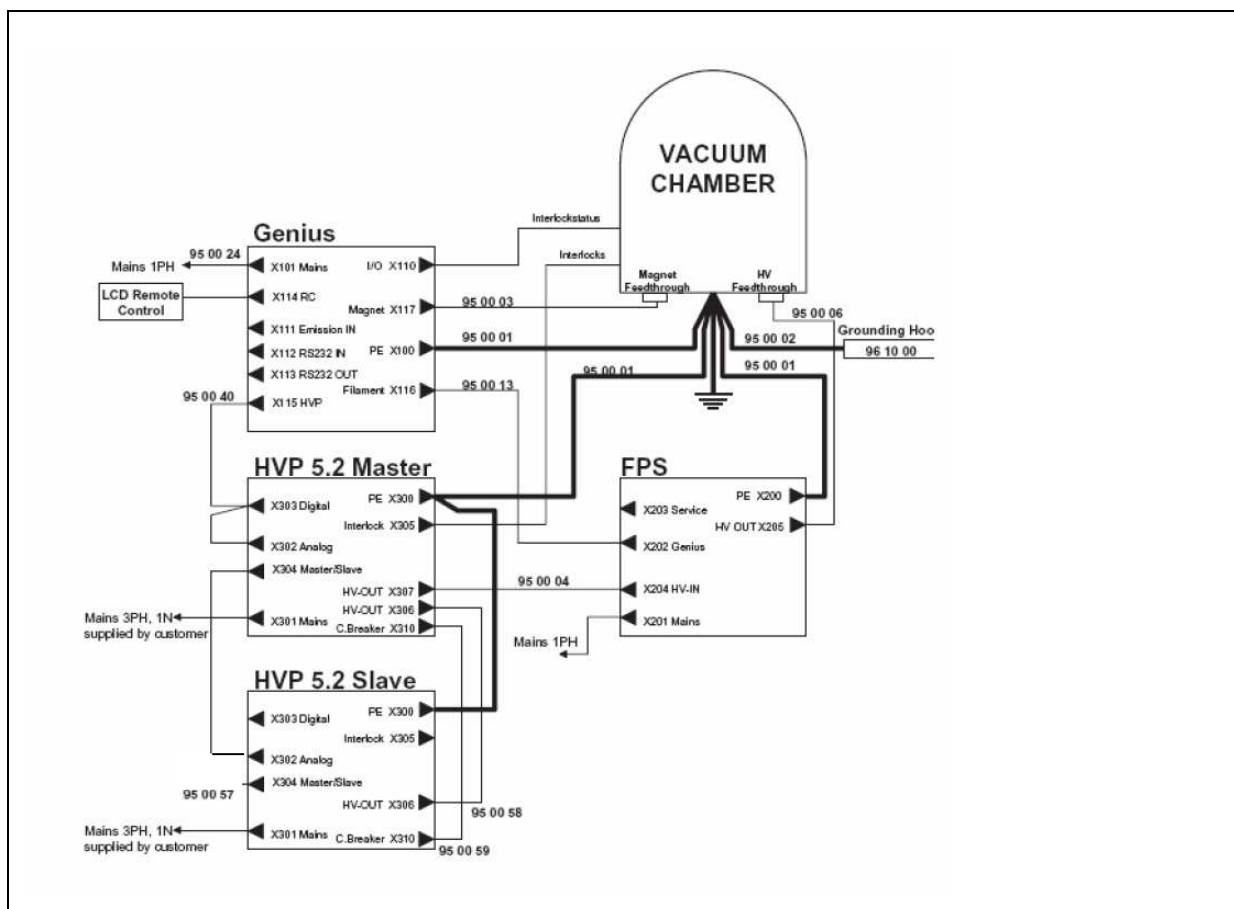

Fig. 6 Wiring diagram of the CARRERA 10/12 high voltage power supply

### 5.5.3 Overview of the electrical connectors and fuses

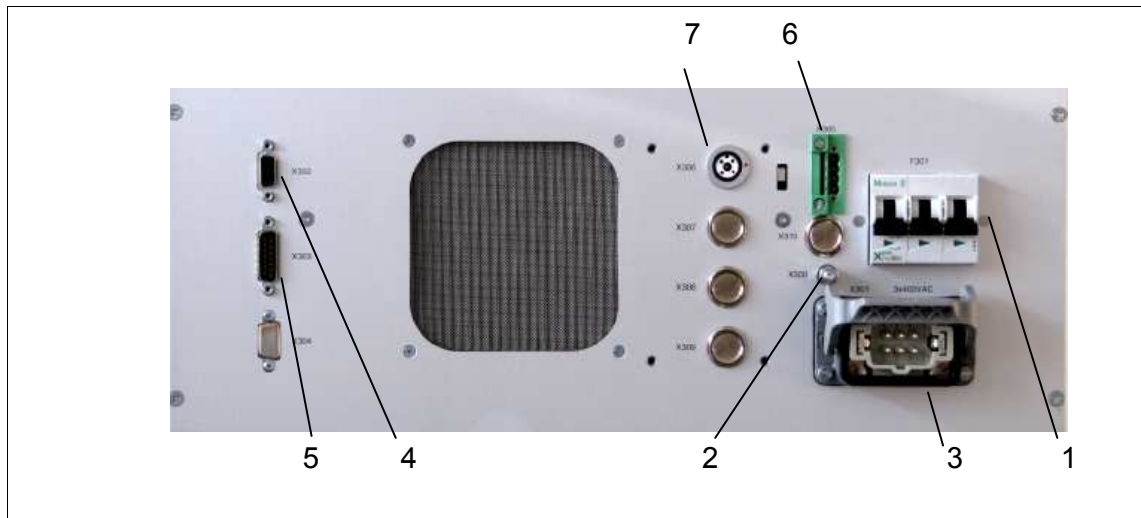

Fig. 7 Overview of electrical connectors and fuses

The electric connectors and fuses are found on the rear panel of the high-voltage power supply unit..

#### Fuses

- 1 Main fuse block **F301** (mains supply line)

#### Electrical connectors

- 2 Earthing screw **X300**
- 3 Mains connector **X301** (Harting plug)  
Connection between the mains supply and the high-voltage power supply unit
- 4 Control line analog output **X302**  
Connection between the high-voltage power supply unit and the control unit
- 5 Control line digital output **X303**  
Connection between the high-voltage power supply unit and the control unit
- 6 Interlock **X305** for the connection of an external fuse chain.
- 7 High-voltage output **X306** to **X309**  
Connection between the high-voltage power supply unit and the filament power supply

The outputs are installed in accordance with the order. The internal arrangement of the connectors is parallel while the fuses are installed in series. Unused connectors must be bridged with blind flanges to prevent the possibility of switching high voltage on (see chapter 3.2).

### 5.5.4 Connection of the high-voltage power supply unit

Connect the high-voltage power supply unit in accordance with the wiring diagram.

The following components are to be connected:

- High-voltage cable (the cable and connectors are part of the delivery or they are already connected to the filament power supply)
- Earthing line
- Control line
- Mains supply line

#### High – voltage cable

The high-voltage cable connects the high-voltage power supply unit with the filament power supply, which is found in the vacuum device.

1. The high-voltage cable is connected to the high-voltage power supply unit with the **X305** connector.

		<b>NOTICE</b>
	<i>Be sure to use the supplied high-voltage cable. It is only this way that you can avoid electromagnetic interference.</i>	

2. Secure the high-voltage cable with the protective metal plate.

		<b>NOTICE</b>
	<i>Optionally, you can connect max. 4 high-voltage cables to the high-voltage power supply unit. Please, note that in versions of the high-voltage power supply unit with more high-voltage outputs all the outputs must be connected. Or the not used outputs must be protected with blind connectors.</i>	

**Earthing line**

- Connect the earthing contact X300 of the high-voltage power supply unit to the earthing point of the vacuum chamber.
- For this purpose use a cable with cable lugs, green/yellow wire sheathing and the cross-section of 16 mm<sup>2</sup>.

**Control Line**

The Y-control cable represents the connection of the high voltage power supply and the genius control unit.

- Connect the high voltage power supply the Genius control unit (Analog: connector X302, Digital: plug X303).

		<b>NOTICE</b>
	<i>The Y-control cable is part of the scope of delivery of the Genius controller .</i>	

		<b>NOTICE</b>
	<i>If you have bought the high-voltage power supply unit without a control unit, use common connectors and connect them in accordance with connector assignment</i>	

**Pin assignment of the interfaces**

Digital interface connector X303: (15-pole Sub-D connector)

Digital Input:	PIN1	High Voltage ON	in
(15-30V DC	PIN2	High Voltage Status	(-)
max. 20 mA Input current)	PIN 3	Reset	in
	PIN 4	Reset	(-)
Digital Outputs:	PIN 5	High Voltage ON	out
(15-30V DC	PIN 6	Hochspannung vorhanden	(+)
max. 20 mA Output current)	PIN 7	Unit O.K.	out
	PIN 8	Unit O.K.	(+)
	PIN 9	Current limit exceeded	out
	PIN 10	Current limit exceeded	(+)
	PIN 11	ARC-Error	out
	PIN 12	ARC- Error	(+)
	PIN 13	Overtemperature	out
	PIN 14	Overtemperature	(+)

**Analoger Interface-Stecker X302:** (9-polige Sub.-D Buchse)

Analog Input:	PIN 1	High voltage-Setpoint	(+)
(0...10 V DC)	PIN 2	High voltage-Setpoint	(-)
Analog Output:	PIN 5	High voltage-actual value	(+)
(0...10 V DC)	PIN 6	High voltage-actual value	(-)
	PIN 7	Current-actual value	(+)
	PIN 8	Current-actual value	(-)

**Interlock connector X305:**

(4-pole serial connector, see Fig. 5-4)

Interlock-loop	PIN 1	Interlock	(+)
(24 V AC)	PIN 2	Interlock	(-)
	PIN 3	Main contactor feedback	(+)
	PIN 4	Main contactor feedback	(-)

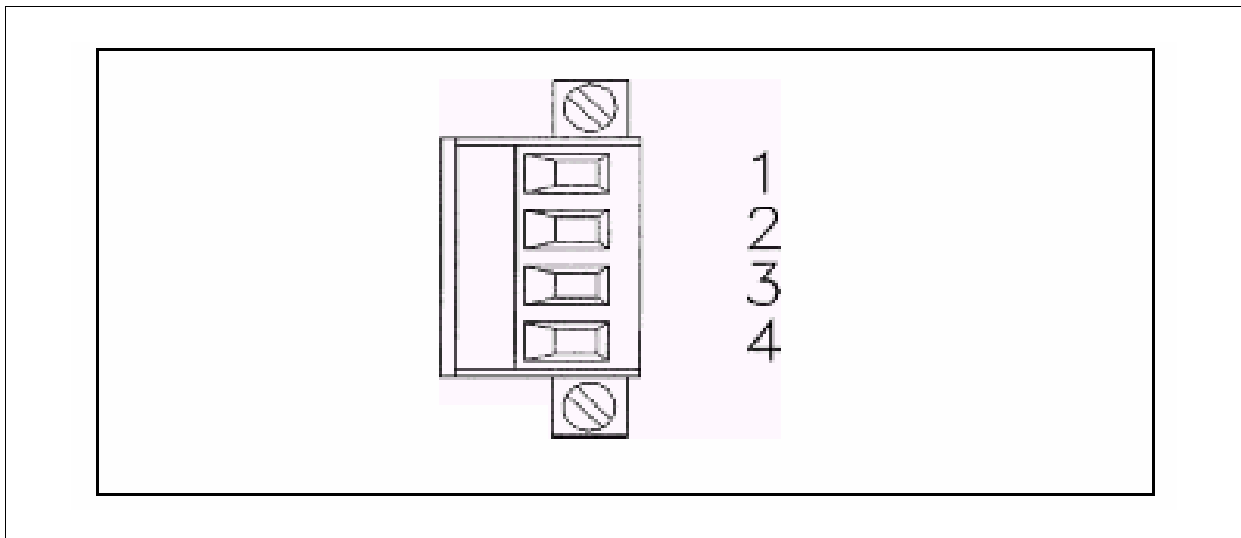

*Fig. 8 Interlock connector*

### Main supply line

The mains supply line is used to connect the high-voltage power supply unit to the mains.

1. Connect the mains supply line with the Harting plug to the X301 connector.

		<b>DANGER</b>
	<i>First make sure whether the mains supply line is without voltage.</i>	

2. Connect the mains supply line with the Harting plug to the X301 connector.

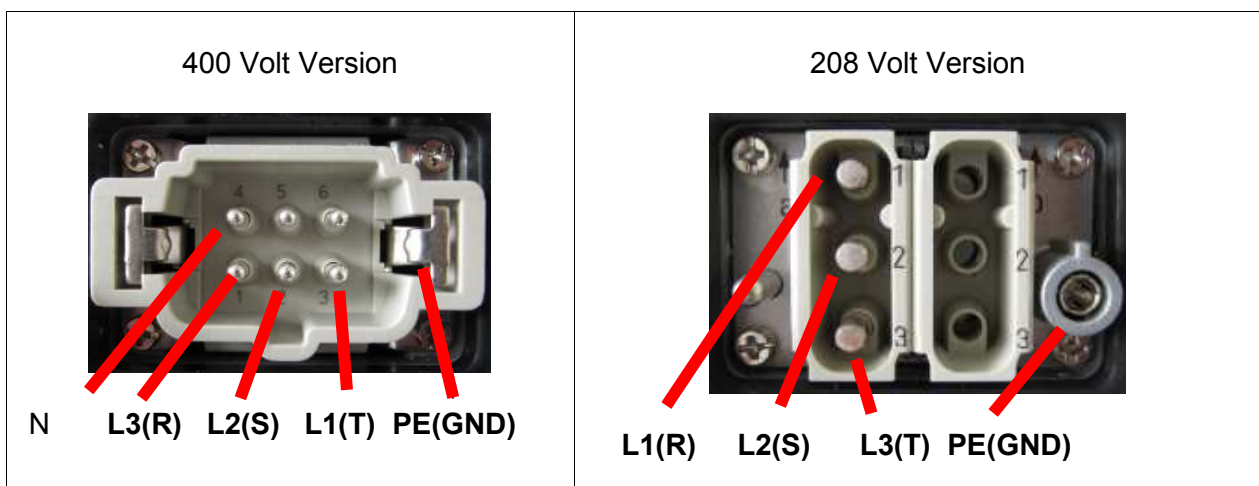

Fig. 9 Harting plug, connector assignment of the power supply cable

**6 Functional description**

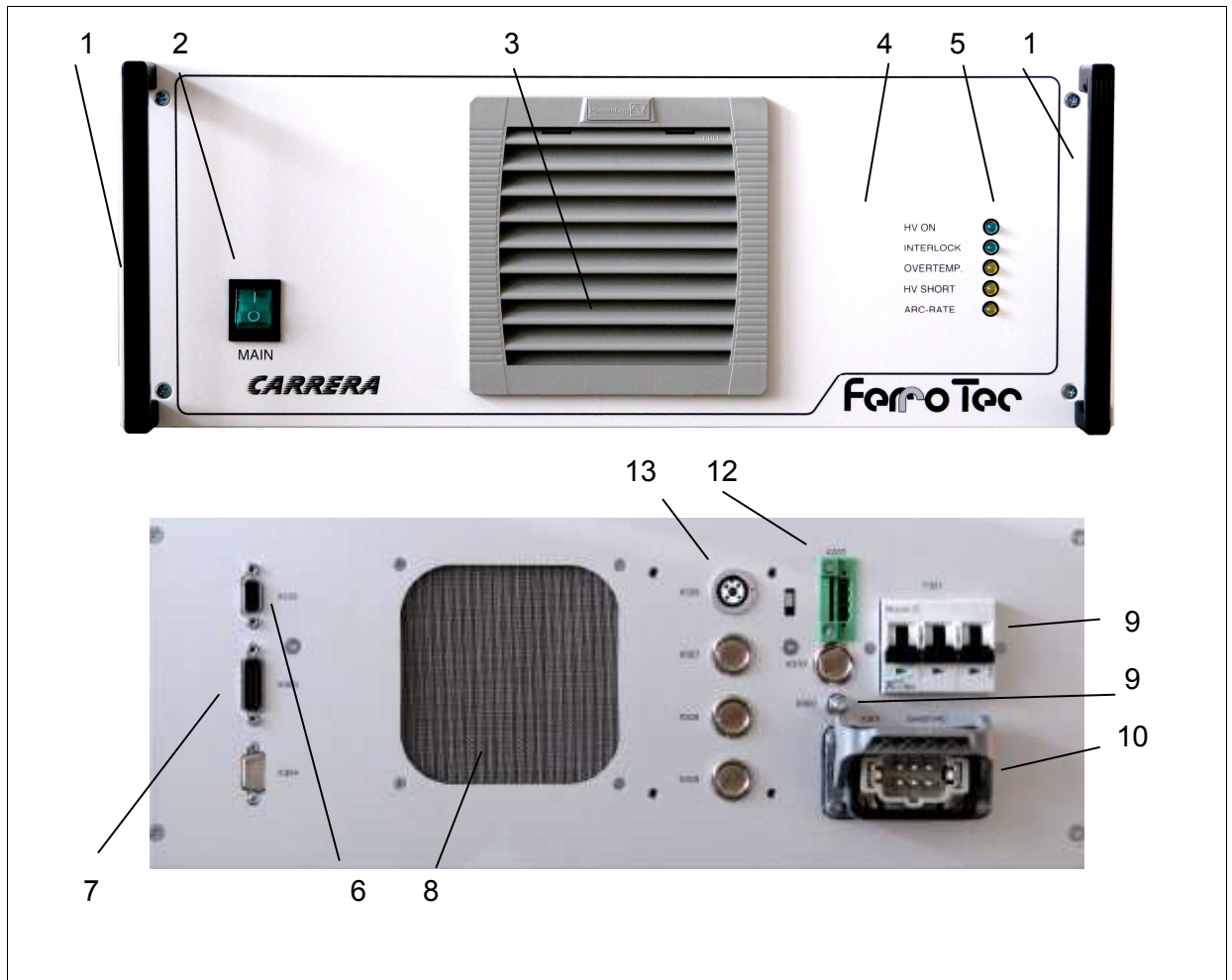

Fig. 10 Overview high voltage power supply

- 1 Transportation handles
- 2 ON / OFF switch
- 3 Air inlet with the filter mat (replaceable)
- 4 Housing
- 5 LED-Indicators
- 6 Analog interface (connection to the control unit)
- 7 Digital interface (connection to the control unit)
- 8 Air outlet
- 9 Earthing
- 10 Mains supply line
- 11 Fuses
- 12 Interlock connector
- 13 High voltage output



### **Function**

The high-voltage power supply unit produces high voltage for an electron beam vaporizer that is incorporated in a vacuum device.

The maximum power output of the unit is 3, 5, 6, 10 or 12 kW.

The operation range of high voltage is from 4kV to 10kV, the range of emission current is 0-1200 mA. The set values are maintained constant independently of the acceptable mains fluctuation of  $-10/+10\%$ .

High voltage and emission current are set with the use of connected control devices. Data are exchanged between the high-voltage power supply unit and the control unit via connected control lines.

All electric connections, i.e.

- connection to the mains;
- connection to the control unit;
- earthing; and
- high-voltage output

are made on the rear panel of the device.

To ensure protection from faulty operation the high-voltage power supply unit is equipped with safety current circuits that disconnect high voltage immediately in case of a failure. Failures are indicated with the use of the LED display. The primary purpose of the safety circuits is to protect the operation personnel, but they also protect the whole system from consequences of faulty operation.

The inside of the high-voltage power supply unit is cooled with air. Generated heat is removed with the use of an internal fan.

The high-voltage power supply unit is designed for installation in a 19" rack.

		<b>NOTICE</b>
	<p><i>To get a complete overview of the operation of the high-voltage power supply unit you should read the instructions concerning the operation of the filament power supply (FPS) in connection with the electron beam vaporizer described in the Appendix</i></p>	

### 6.1 Putting in operation for the first time (for specialized personnel only)

		<b>NOTICE</b>
	<p><i>The equipment may only be put in operation by trained specialized personnel.</i></p>	

The high-voltage power supply unit is put in operation together with the whole system.



The components of the complete system

- High voltage power supply HVP
- Control unit Genius
- Filament power supply FPS
- Vacuum system
- Electron beam evaporator

must be completely installed and connected before the system is first put in operation.

To put the system in operation carry out the following tests:

1. Check
  - the earthing connections,
  - the mains supply,
  - the control lines,
  - the high voltage cablefor correct and tight connection.
2. Test the safety circuit (see chapter **Fehler! Verweisquelle konnte nicht gefunden werden.**, Interlock-connector X304).
3. Test the emergency switch system

	 <b>NOTICE</b>
	<p><i>Carry out the relevant tests in compliance with 60 204, item 19. Before carrying out the work, remove the Harting plug to avoid any damage to the electronics.</i></p> <p><i>Note VDE 0721-3032 (test procedures for electronic heating units with electron guns)</i></p> <p><i>The earthing cables must be laid directly and made as short as possible, coils of earthing cable can lead to problems and are therefore forbidden.</i></p>

## 7 Operation



### WARNING

The high voltage power supply can only be operated by trained personnel.

### 7.1 Operation and displaying elements

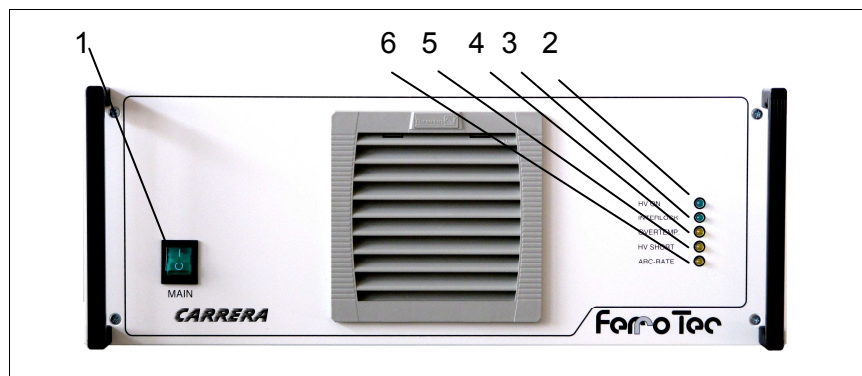



Fig. 11 Overview of operation and display elements

The operation and displaying elements are found on the front panel of the high-voltage power supply unit.

- 1 Ein Main “On/Off” switch is used to switch the high-voltage power supply on and off.
- 2 “HV on” LED (green) is lit if the high-voltage power is at least on the level of 70% of the set value of high voltage.
- 3 “Interlock” LED (green) is lit if the circuit of connected safety contacts is closed.
- 4 “Over-temperature” LED (yellow) is lit if the device has been disconnected due to excessive temperature.
- 5 “HV short” LED (short circuit – yellow) is lit if the device has been disconnected due to a short circuit
- 6 “ARC rate” LED (yellow) Is lit if the device has shut off because of ARC rate

## 7.2 Operation modes

	 <b>NOTICE</b>
	<i>The operating modes are described in the separate operating instructions of the components of the operating system.</i>



### 7.2.1 Operation

The high-voltage power supply unit can only be operated in connection with a control unit of the corresponding vacuum device with a built-in electron beam vaporizer and filament power supply.



### 7.2.2 Switching on

The system should be switched on as follows:



1. Check whether the fuses in the main fuse block of the high-voltage power supply unit are properly connected.
2. Switch on the GENIUS control unit.
3. Switch on the main "On/Off" switch of the high-voltage power supply unit.

	 <b>NOTICE</b>
	<i>Keep minimum time pause of 5 seconds between switching on the mains supply and switching on high voltage.</i>

4. Check for the green LED „Interlock“ is lit.  
Check the set value of emission current.
5. Switch on high voltage on the GENIUS control unit.



	 <b>NOTICE</b>
	<i>Observe instruction in operation manuals of the whole system.</i>

### 7.2.3 Switching off

		<b>NOTICE</b>
	<p><i>Please note, that the high-voltage power supply unit will only be switched off when the production process in the vacuum device has finished.</i></p>	

When switching the system off, proceed as follows:

1. Switch off high voltage on the GENIUS unit.  
Switch off the main "On/Off" switch of the high-voltage power supply unit.

		<b>DANGER</b>
	<p><i>Before you touch the electron beam vaporizer, earth it with the earthing rod to remove any possible charge.</i></p>	

**8 Cleaning/Maintenance**

		<b>DANGER</b>
	<p><i>The chapter <b>Cleaning / Maintenance</b> is intended for skilled personnel only. Maintenance, cleaning and repair work may only be carried out by skilled personnel.</i></p>	

**Skilled Person**



A person with relevant technical training, know-how, experience and knowledge of applicable standards to enable him or her to assess the work assigned to him or her and to perceive potential risks.



**The above definition is based on EN 60204-1.**





		<b>DANGER</b>
	<p><i>The operating and maintenance personnel are trained in the use of the electron beam evaporator at its point of installation by personnel from FERROTEC GmbH. Should you have any questions or be uncertain about anything, please contact FERROTEC GmbH.</i></p>	

For trouble-free operation of the electron beam evaporator it is absolutely essential that it is cleaned and serviced at regular intervals.

		<b>NOTICE</b>
	<p><i>Maintenance and cleaning of <b>vendor components</b> (e.g. drive motor) are described in their manufacturer's separate <b>instruction handbooks</b>. They are contained in the technical reference material.</i></p>	

		<b>NOTICE</b>
	<p>The times specified in this instruction handbook are based on one-shift operation (8 hours/day, 22 days/month, 12 months/year).</p> <p><b>D</b> = Daily    <math>\frac{1}{2}</math> Y = Half-yearly  <b>W</b> = Weekly    Y = Yearly  <b>M</b> = Monthly    W.Hr. = Work hours  <math>\frac{1}{4}</math> Y = Quarterly    MIH = Manufacturer's instruction handbook</p>	

		<b>NOTICE</b>
	<p>The shutdown procedure may only be initiated by skilled personnel according to the definition in DIN EN 60 204 (see also chap. 3.3).</p>	

      		<b>DANGER</b>
	<p>The following procedure for switching off is to be followed without fail before carrying out any cleaning, repair or maintenance work.</p> <p>1. Switch off the unit:</p> <ul style="list-style-type: none"> <li>- Switch off the high voltage with the HV button at the GENIUS.</li> <li>- Turn off the On/Off switch at the HVP high-voltage mains device.</li> <li>- Pull out the mains plugs at the high-voltage mains device X301, control X101 and the filament current supply X201.</li> <li>- Wait for at least 3 minutes before starting work on the electrical equipment. The capacitors must discharge themselves.</li> </ul> <p>2. For maintenance and repair work:</p> <ul style="list-style-type: none"> <li>- Make sure that the machine is electrically dead,</li> <li>- Use an earthing rod to earth all the high-voltage feedthroughs.</li> </ul> <p>There is a danger to life and limb for the personnel if this procedure is not followed.</p>	



### 8.1 Complete Daily Cleaning

		<b>DANGER</b>
	<p><i>The shutdown procedure must be followed before any cleaning, maintenance or repair work is carried out (see chap. 4.5). Do not use sharp objects or tools to clean the machine unless they are explicitly intended for this purpose.</i></p>	

### 8.2 Cleaning

Clean the front panel with a wet piece of cloth once a month.

		<b>NOTICE</b>
	<p><i>Do not use any aggressive cleaning agents and sharp objects.</i></p> <p><i>Proceed in such a way that no water can get into the high-voltage power supply unit.</i></p>	

### 8.3 Maintenance

		<b>DANGER</b>
	<p><i>During maintenance work pay attention to the <b>dangers from electric current!</b></i></p>	

In the case of the high-voltage power supply unit the maintenance and cleaning work is only limited to:

- Cleaning of the housing; and
- Replacement of the filter mat at the air inlet.

		<b>NOTICE</b>
	<p><i>If there is a need of other maintenance work, please, contact the FERROTEC GmbH Company.</i></p>	

### 8.3.1 Function test plan

	Interval for One-Shift System				
	W	M	½ Y	Y	MIH
Emergency stop system (emergency stop buttons)		X			
Mains isolator (main switch)				X	
Check all electric terminal and plug connections			X		
Push buttons and switches on the switch cabinet		X			
Check all plug, screw and clamped joints for firmness and tighten if necessary				X	
Function check of the electric drives					X



### 8.3.2 Inspections

1. Carry out a visual inspection of the switch cabinet.  
Check:
  - the wiring for kinks, abrasions and burns,
  - the covers and insulation for damage,
  - the switch cabinet doors for ease of movement.
2. Carry out a function test of all subassemblies in setting mode and in manual mode.



If all the functions work properly, the **machine is handed over** to the operating personnel.

### Replacement of the filter mat

The air that is suctioned by the fan passes through a filter mat that catches dust particles. This filter mat should be replaced every 6 months. The cleaning intervals must be adapted to the ambient conditions



		<b>NOTICE</b>
	<p><i>Please note that regular replacement of the filter mat is necessary as dust deposits in the inner space of the high-voltage power supply unit can cause flashovers.</i></p>	

If you operate the high-voltage power supply unit without a filter mat, you should send the unit regularly to the FERROTEC GmbH Company for cleaning.

		<b>DANGER</b>
	<p><i>Before you start replacing the filter mat you must switch high voltage off Carry out the switching-off procedure (see Chapter 8.).</i></p>	

Proceed as follows:



1. Draw the filter element out of the device towards the front.
2. Replace the filter mat with a new one.
3. Insert the filter element back into the unit.

		<b>NOTICE</b>
	<p><i>The filter element (part no. 1-90 00 69) can be ordered from the FERROTEC GmbH Company.</i></p>	

## 8.4 Inspection of the machine



After completing cleaning, maintenance and repair work:

1. Check that the protective conductor connections are firm.
2. Check that the work has been carried out properly and fully.

		<b>NOTICE</b>
	<i>After checking and replacing spare and wearing parts make sure that all safety systems are in working order..</i>	

- If all the functions work properly, the electron beam evaporator is **handed over** to the **operating personnel**.

## 9 Troubleshooting

		DANGER
<p><i>The situations and information on faults, their causes and correction in this chapter are described in such a way that they can be understood by skilled persons (see definition chapter. 3.3 „Safety Precautions“)with training in</i></p> <ul style="list-style-type: none"> <li>- electrical engineering/electronics</li> <li>- mechanical engineering/maintenance.</li> </ul> <p><i>These technicians must be equipped with the proper tools and test materials.</i></p> <p><i>The shutdown procedure (see chap. 8) must be carried out before all maintenance and repair work.</i></p> <p><i>If the measures described below do not prove successful, please contact FERROTEC GmbH.</i></p>		

Fault	Cause	Remedy
Power supply cannot be switched ON	Disconnected mains plug  The high-voltage connector is not connected and locked  Safety conditions are no met	Connect the mains plug Plug Connect and lock the high-voltage connector Ccheck safety interlock circuit
The “Over-temperature” LED is lit	The fan is not operating  Dirty filter mat	Contact the FERROTEC Service Dept. Replace the filter mat
The “HV short” LED is lit	Short circuit	Clean the electron beam vaporizer
The "ARC rate" LED is lit	Too low process pressure ARC rate has been exceeded	Use a lower process pressure Change the ARC rate setting

## 10 Emergency

In the event of an emergency:

1. Press the emergency stop button on the master control unit.  
The emergency stop button is released by pulling out or turning anticlockwise/clockwise.
2. Switch off the main switch if necessary.

## 11 Dismantling/Disposal

### Dismantling

Dismantling may only be performed by skilled personnel.  
Make sure the shutdown procedure is followed before beginning dismantling work.

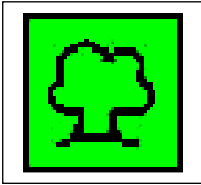

### Disposal

The machine is primarily made of copper (except for the electrical equipment) and must be disposed of in accordance with local environmental protection regulations

Oil and cleaning materials must be disposed of in accordance with the local laws and the instructions given in the material safety data sheets

Contaminated cleaning tools (brushes, cloths, etc.) must also be disposed of in accordance with the manufacturer's instructions.

## 12 Appendix; Options

### 12.1 Appendix 1; Control unit GENIUS

Control unit **GENIUS**  
including hand remote

**The options include:**

Overview and Intended Use /Explanations

Table of content / pictures

Safety

General Warnings

Technical data

Scope of delivery

Transportation, Packaging and Storage

Set up and mounting

Function and operation

Control and status elements

Initial start up

Modes of operation

Cleaning / Maintenance

Fault, Cause, Remedy

Dismantling/Disposal

Emergencies



## 12.2 Appendix 2; Filament Power Supply FPS

**The options include:**

Overview and Intended Use /Explanations

Table of content / pictures

Safety

General Warnings

Technical data

Scope of delivery

Transportation, Packaging and Storage

Set up and mounting

Function and operation

Control and status elements

Initial start up

Modes of operation

Cleaning / Maintenance

Fault, Cause, Remedy

Dismantling/Disposal

Emergencies