



DIGITAL SWEEP

INSTRUCTION MANUAL



Copyright © TELEMARK, 1995-2020 – All rights reserved

Manual Rev 1.0.0 June 2020

telemark.com

This manual is for software version 4.2.19212 and above.
Current interface and software options might be different. Contact manufacturer for current manual release if the software interface or functions are different from this manual or download the current version of this manual at

<https://telemark.com/e-beam-power-supplies/sweep-controllers/>

Brand and product names are trademarks or registered trademarks of their respective companies

TABLE OF CONTENTS

1	INTRODUCTION	7
1.1	Intended Use	7
1.2	Liabilities and Warranty	7
1.3	Safety	8
1.3.1	Personnel Qualifications	8
1.3.2	Illustration of Residual Dangers	8
1.4	General Safety Instructions	9
2	TECHNICAL DATA	11
2.1	General Data	11
2.1.1	Mechanical Data	11
2.1.2	Ambience	12
2.1.3	Use and Operating Modes	12
2.1.4	Standards	12
2.2	Mains Connection	13
2.3	Pack List	13
2.4	Specifications	14
2.5	Features	15
2.6	Interfaces	15
2.6.1	Input/Output Interface	15
3	INSTALLATION	16
3.1	Unpacking	16
3.2	Mechanical Installation	16
3.2.1	Required components	17
3.3	Installation	17
3.3.1	Rack Installation	17
3.4	Controller Connecting	18
3.4.1	Front Panel	18
3.4.2	Rear Panel	19
3.4.3	Mains Connection	20
3.4.4	Grounding	20

3.4.5	Remote Control - J2	22
3.4.6	Host – J1	23
3.4.7	Output - J3	23
3.5	List of Accessories or Supplies	25
4	USING THE DIGITAL SWEEP	26
4.1	Front Panel.....	26
4.1.1	Main Power Switch.....	26
4.1.2	Power On LED indicator	27
4.1.3	Handheld	27
4.1.4	LCD Touchscreen	27
4.1.5	LED, RUN	27
4.1.6	LED, REMOTE CONTROL	27
4.1.7	LED, HANDHELD	27
4.2	Avatar Handheld	28
4.2.1	Four-way and OK Momentary switch.....	28
4.2.2	Joystick	29
5	CONFIGURATION	31
5.1	Unlocking	31
5.2	Configure Pocket Setup	32
5.3	Configure Pattern	34
5.3.1	Sine	35
5.3.2	Triangle	35
5.3.3	Circle	36
5.3.4	Line	36
5.3.5	Point.....	37
5.4	Display Tail Length.....	37
6	OPERATION	39
6.1	General Operation.....	39
6.1.1	Power-Up	39
6.1.2	Power-Down.....	39
6.2	Pattern Selection.....	40
6.3	Move Pattern.....	40
6.4	Run On/Off.....	41
6.5	Remote On/Off	41
7	MAINTENANCE AND SERVICE.....	43

7.1	Maintenance.....	43
7.2	Cleaning.....	43
8	STORAGE AND DISPOSAL.....	44
8.1	Packaging	44
8.2	Storage.....	44
8.3	Disposal	44
8.4	WEEE	44
9	ERRORS AND WARNINGS	46
9.1	Error Codes.....	46
9.2	Interlock Fail.....	46
10	WARRANTY CONDITIONS	48
10.1	Limited Warranty	48

TABLE OF FIGURES

Figure 1-1, Keep Foreign Material Out of the Digital Sweep	9
Figure 2-1, Sweep Reference Dimensions.....	11
Figure 3-1, Front Panel Connection	18
Figure 3-2, Avatar Sweep Handheld	19
Figure 3-3, Rear panel Digital Sweep Controller	19
Figure 3-4, Three-conductor cable with protective ground (example)	20
Figure 3-5, Connections	21
Figure 3-6, Dsub25 pinouts	22
Figure 3-7, Host Port.....	23
Figure 3-8, Telemark standard Coil Wire Reference Code.....	23
Figure 3-9, Telemark Source Standard Direction Reference.....	24
Figure 3-10, Typical 8 pin Sweep/coil Installation	24
Figure 3-11, Typical 4 Pin Sweep/coil Installation	24
Figure 4-1 - Front Panel	26
Figure 4-2, Avatar Sweep Handheld	28
Figure 4-3, Four way and OK switch Operation	29
Figure 5-1, Unlocking Screen.....	31
Figure 5-2, Configure Pocket Setup	32
Figure 5-3, Pattern Button	32
Figure 5-4, Pocket Setup Button	32
Figure 5-5, Pocket Setup, Center	33
Figure 5-6, Pocket Setup, Direction.....	33
Figure 5-7, Copy Pocket Setup	34
Figure 5-8, Configure Pattern.....	34
Figure 5-9, Setup Pattern, Sine	35
Figure 5-10, Setup Pattern, Triangle	35
Figure 5-11, Setup Pattern, Circle	36
Figure 5-12, Setup Pattern, Line	36

Figure 5-13, Setup Pattern, Point 37

Figure 5-14, Display Tail Length 37

Figure 5-15, Display Tail Length Adjustment..... 38

Figure 5-16, Display Tail Length Hide 38

Figure 6-1, Touchscreen Display 39

Figure 6-2, Pattern Selection..... 40

Figure 6-3, Select Pattern Move..... 40

Figure 6-4, Move Pattern..... 40

Figure 6-5, Run On Mode..... 41

Figure 6-6, Run Off Mode..... 41

Figure 6-7, No Pattern Selected 42

Figure 6-8, Remoted Pattern Selected 42

Figure 8-1, WEEE Symbol 45

Figure 9-1, Interlock Fail..... 46

1 INTRODUCTION

Please read this manual carefully to ensure optimum operating conditions right from the start. This user manual handbook contains important information about the functionality, installation, start-up and operation of the Model Digital Sweep.

1.1 Intended Use

The Telemark Digital Sweep is intended for use with electron beam (EB) sources such as the Telemark line of EB sources and with other compatible EB sources that use electromagnetic deflection or combinations of electromagnetic deflection and permanent magnet focusing. The sweep output drives the latitude and longitude (X, Y) coils of an electron beam source to move the beam spot.

The device is referred to as Digital Sweep in the remainder of this manual.

1.2 Liabilities and Warranty

Telemark is not liable for damages resulting from improper use of the device and the guarantee expires, if the user, or third party:

- ignores information contained in this manual,
- utilizes the product in a manner inconsistent with intended purpose,
- makes any modification or alteration of the product,
- unit should not be used with unauthorized accessories (compatible accessories, types and models can be found in the product documentation)

Telemark reserves the right to make changes without prior notice. Illustrations may vary depending on the version of the device.

1.3 Safety

1.3.1 Personnel Qualifications

All work described in this document may only be carried out by persons who have suitable technical training and the necessary experience or who have been instructed by the end user of the product.

1.3.2 Illustration of Residual Dangers

This Operating Manual illustrates safety notes concerning residual dangers as follows:



Information on preventing any kind of physical injury.



Information on preventing extensive equipment and environmental damage.



Information on correct handling or use. Disregarding safety notes can lead to malfunctions or equipment damage.

Note: Indicates particularly important, but not safety-relevant information.

1.4 General Safety Instructions

For all work you are going to do, adhere to the applicable safety regulations. Also observe all safety notes given in this document and forward the information to all other users of the product. Pay attention to the following safety notes:



Mains voltage.

Contact with live parts is extremely hazardous when any objects are introduced, or any liquids penetrate the device.

Make sure that no objects enter the device. Keep the device dry.

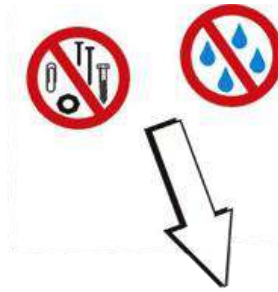

Figure 1-1, Keep Foreign Material Out of the Digital Sweep



Improper use.

Improper use can damage the Digital Sweep.

Use the Digital Sweep only as intended by the manufacturer.



Improper installation and operation data.

Improper installation and operation data may damage the Digital Sweep.

Strictly adhere to the stipulated installation and operation data.

2 TECHNICAL DATA

2.1 General Data

2.1.1 Mechanical Data

Dimensions:	19-inch (483mm) rack 2U, 3 1/2" (89mm) high x 9 3/8" (238mm) deep, See Fig. 2-1
Net Weight:	10.6 lb. (4.8 kg)

Controller Installation: 19" Rack standard or Bench Top unit

Assembly: Connected outside of a high vacuum system to electron beam source that is inside a high vacuum system.

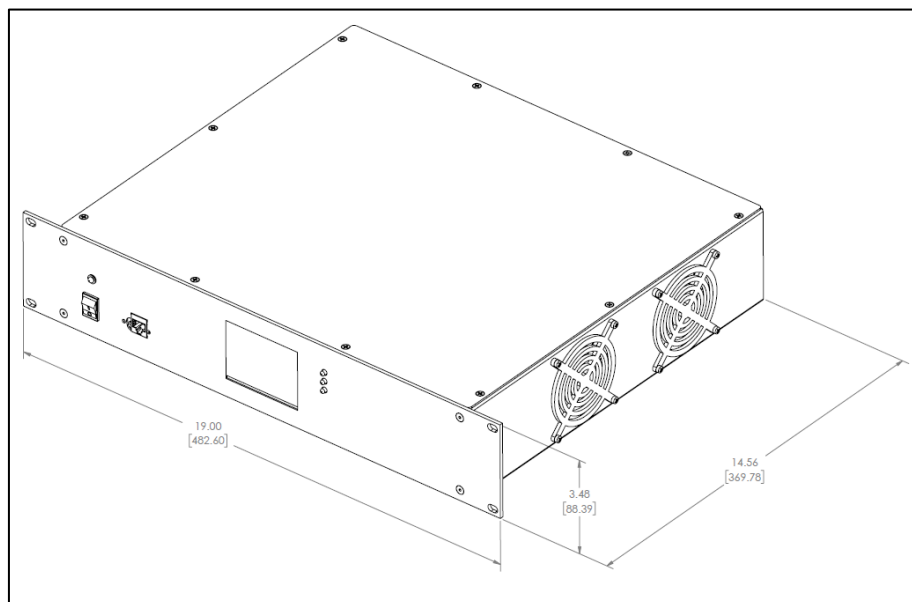

Figure 2-1, Sweep Reference Dimensions

2.1.2 Ambience

Temperature Storage:	-20...+60 °C
Operation Temperature:	+5...+40 °C
Relative Humidity:	Max. 80 % (up to 31 °C), decreasing to max. 50 % (above 40 °C)

Use indoor only

Altitude:	max. 2000 m n.p.m.
The degree of dust standard:	II
Humidity resistance:	IP20

2.1.3 Use and Operating Modes

There are two common operation modes:

1. Manual control, with the touchscreen on the front panel
2. Hardware remote control with I/O interface

This mode is active by pressing the Remote button on the touchscreen. In this mode the only button available on the touchscreen is to return to manual mode.

2.1.4 Standards

Conformity with the Directive relating to electrical equipment designed for use within certain voltage limits 73/23/EWG

Conformity with the Directive relating to electromagnetic compatibility 89/336/EWG

Harmonized and international/national standards and specifications:

EN 61010-1 (Safety requirements for electrical equipment for measurement, control and laboratory use)



EN 61000-6-2 (Electromagnetic compatibility generic immunity standard)

EN 61000-6-3 (Electromagnetic compatibility generic emission standard)



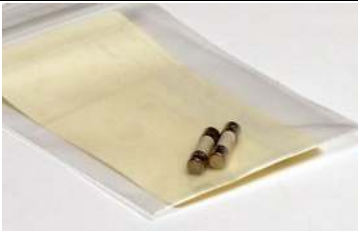

2.2 Mains Connection

Voltage:	90 to 264 VAC, 1 phase operation
Frequency:	47 - 63 Hz
Current consumption:	Max. 0.4 A at 120V, Max. 0.4 A at 230V
Power consumption:	Max. 17 W
Overvoltage category II	
Protection class 1	
Connection US	
appliance connector	IEC 320 C14
Fuse	Slow Blow, 5 A, 250 V, 5mm x 20mm

2.3 Pack List

Part No.	Quantity	Description	
122-4002-4	1	Cable Kit, Digital Sweep	
135-0301-2	1	Digital Sweep Ship Fuse Kit	
135-0501-1	1	Assembly, Sweep Handheld, Avatar Joystick	
135-0600-1	1	Chassis Assembly, Digital Sweep	

122-4002-4, Cable Kit, Telemark Digital Sweep

Part No.	Quantity	Description	
122-0108-1	1	Cable, Sweep (XY), 3p Philmore/Loose 25 ft.	
122-1112-1	1	Cable, Sweep Joystick 9 pin D, 10 feet	
124-0925-7	1	Connector Kit, 25 Pin, D-Sub F, w/ Intlk loop	
376-9010-1	1	Power Cord	

2.4 Specifications

Electrical	
Input Supply Voltage	90 to 264 Vac (47 63 Hz), 1 phase operation *
Input Current	Max 0.4A
Mode of operation	Electron beam source pocket sweeping with one of five shapes
Methods of control	Local or remote through Communication Interface
Dimensions	Controller dimensions: 19-inch (483mm) rack 2U, 3 1/2" (89mm) high x 9 3/8" (238mm) deep
Weight	Net Weight: 10.6 lb. (4.8 kg)

I/O control	
Analog Interface	25 Dsub female connector, 9 Inputs: 75V reverse breakdown Passive Mode (contact closure) Outputs: 3 relay contacts NO @ max 1A, 24 DC or AC

2.5 Features

The Sweep outputs user adjustable patterns to EB sources. A Sweep is needed for positioning and moving the e-beam around the source's crucible pocket in a defined pattern. The beam movement helps heat (and evaporate) the crucible pocket's material more evenly. Sweeping is accomplished by running current through magnetic coils next to the crucible pocket. One output runs to each of two coils (latitude and longitudinal), which are placed perpendicularly to each other. Their magnetic fields affect the position/motion of the electron beam.

A simple front panel touch screen color LCD (liquid crystal display) and handheld joystick interface is used to configure and run EB sweep patterns. The LCD display allows for easy visualization of each pattern. The LCD panel prompts the user through the various steps of a normal operation.

2.6 Interfaces

2.6.1 Input/Output Interface

Connector: D-Sub 25 male connector

Refer to chapter 3.6.5 for details

No of Digital Inputs: 9 – Inputs are contact closure to sweep reference. Input voltages greater than 5VDC may damage the Digital Sweep.

Response time: 100 ms max

No of Digital Outputs: 3 – Relay; 50V maximum compliant

Response time: 100 ms max

3 INSTALLATION

3.1 Unpacking

1. Visually inspect the transport packaging for signs of external damage
2. Unpack the Digital Sweep and put the packaging material aside

Note: Keep the packaging material for later use. The Digital Sweep must be stored and transported in the original packaging material only.

3. Examine the Digital Sweep for completeness
4. Visually inspect the Digital Sweep for signs of damage



Damaged product.

Putting a damaged product into operation can be extremely dangerous.

Never attempt to put a damaged product into operation. Secure the damaged product from unintended operation. Send a damage report to the haulage company or the insurer.

3.2 Mechanical Installation

Digital Sweep can be used in the following ways: as a bench top device, mounted in a control panel or mounted in a 19 "rack. In each case, consider the following important safety information:



The temperature of the environment. Exceeding the allowable temperature of the device may damage the unit.

Make sure that the maximum permissible ambient temperature is not exceeded, and the air can circulate freely through the ventilation slots. Do not expose the device to direct sunlight.

3.2.1 Required components

The following is the minimum list of components required for setting up the sweep for safe operation.

- Electron beam source with an electromagnetic coil in working order.
- Vacuum system.
- 19-inch rack with 115/230VAC, 50/60 Hz power to house the controller.
- Cable from ground on chamber to ground stud on sweep controller.

3.3 Installation

The Electron Beam source (EB source) Sweep is designed to be mounted in a standard 19-inch electronic instrument cabinet. Other suitable places on a vacuum system may be used. The installation procedures are described below.

3.3.1 Rack Installation

The Digital Sweep is designed for installation into a rack according to DIN 41 494 (19", 2 HU).



Ambient temperature.

Exceeding the maximum permitted ambient temperature may damage the device.

Make sure that the maximum permitted ambient temperature is not exceeded. Do not expose the device to direct sunlight.



Protection class of the rack.

If the product is installed in a rack, it is likely to lower the protection class of the rack (protection from foreign bodies and water) e.g. according to the EN 60204-1 regulations for switching cabinets.

Take appropriate measures to restore the required protection class of the rack.

3.4 Controller Connecting



Figure 3-1, Front Panel Connection

3.4.1 Front Panel

A – Handheld, Avatar Joystick Sweep Remote Control Connection

The Handheld can be used when needed and removed when not needed.



Figure 3-2, Avatar Sweep Handheld

3.4.2 Rear Panel

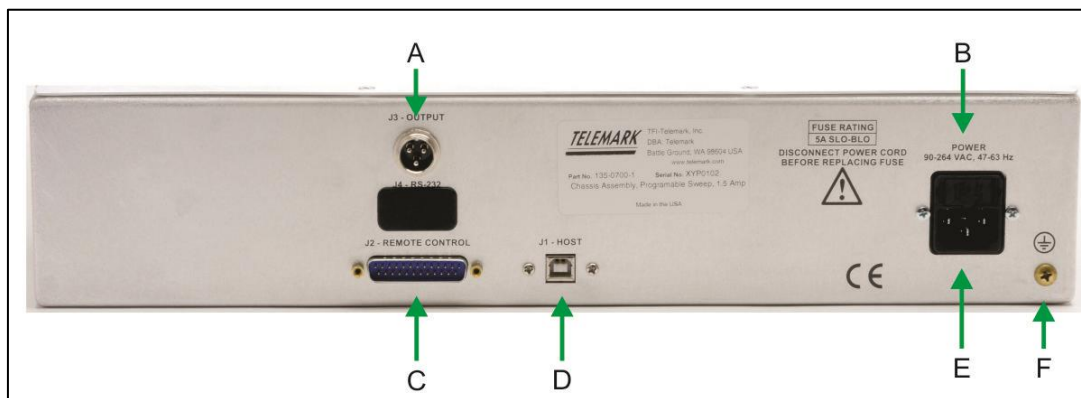

Figure 3-3, Rear panel Digital Sweep Controller

- A – **Sweep Output** (see chapter 3.4.7 for details)
- B – **Main power socket** IEC C13 (see chapter 3.4.3 for details)
- C – **Remote Control**, Input/Output interface connector Dsub 25 female (see chapter 3.4.5 for details)
- D – **USB connector**, Type B (see chapter 3.4.6 for details)
- E – **Fuses**
- F – **Grounding screw** (see chapter 3.4.4 for details)

The configuration of the available connections and photographs of cables is described in the following sections.

3.4.3 Mains Connection

The mains connection is designed for a mains cable which contains IEC 320 connector on the device side. A mains cable is supplied with the device. If the plug is not compatible with your wall socket, you should replace it with a suitable mains cable:

Three-conductor cable with protective ground

Conductor cross-section $3 \times 1.5 \text{ mm}^2$ or larger

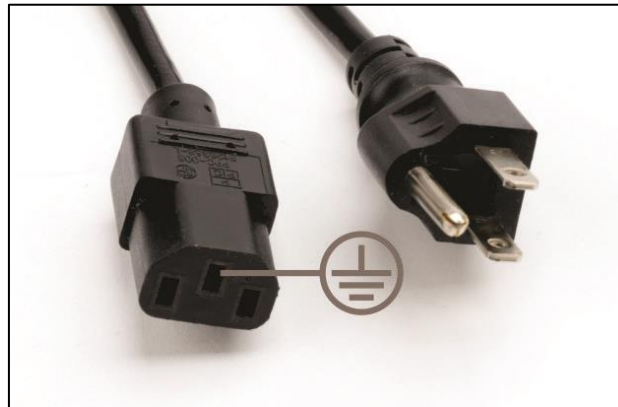

Figure 3-4, Three-conductor cable with protective ground (example)



Mains power.

Improperly grounded devices can be extremely dangerous in the event of a fault. Use three-wire mains or extension cables with protective ground only. Plug the mains cable into wall sockets with protective ground only.

1. Connect the appliance connector of the mains cord with the mains connection of the device
2. Connect the plug of the mains cable with the wall socket

Note:

If the device is installed in a switching cabinet, the mains power can be supplied via a switchable central power distributor.

3.4.4 Grounding

Grounding screw (Fig. 3-3, the reference F) should be used to connect the Digital Sweep with the main grounding system in which it operates. It is recommended to use a cable with a minimum section of 2.5 mm^2

If required, connect the vacuum system ground from the earthing screw using the protective conductor.

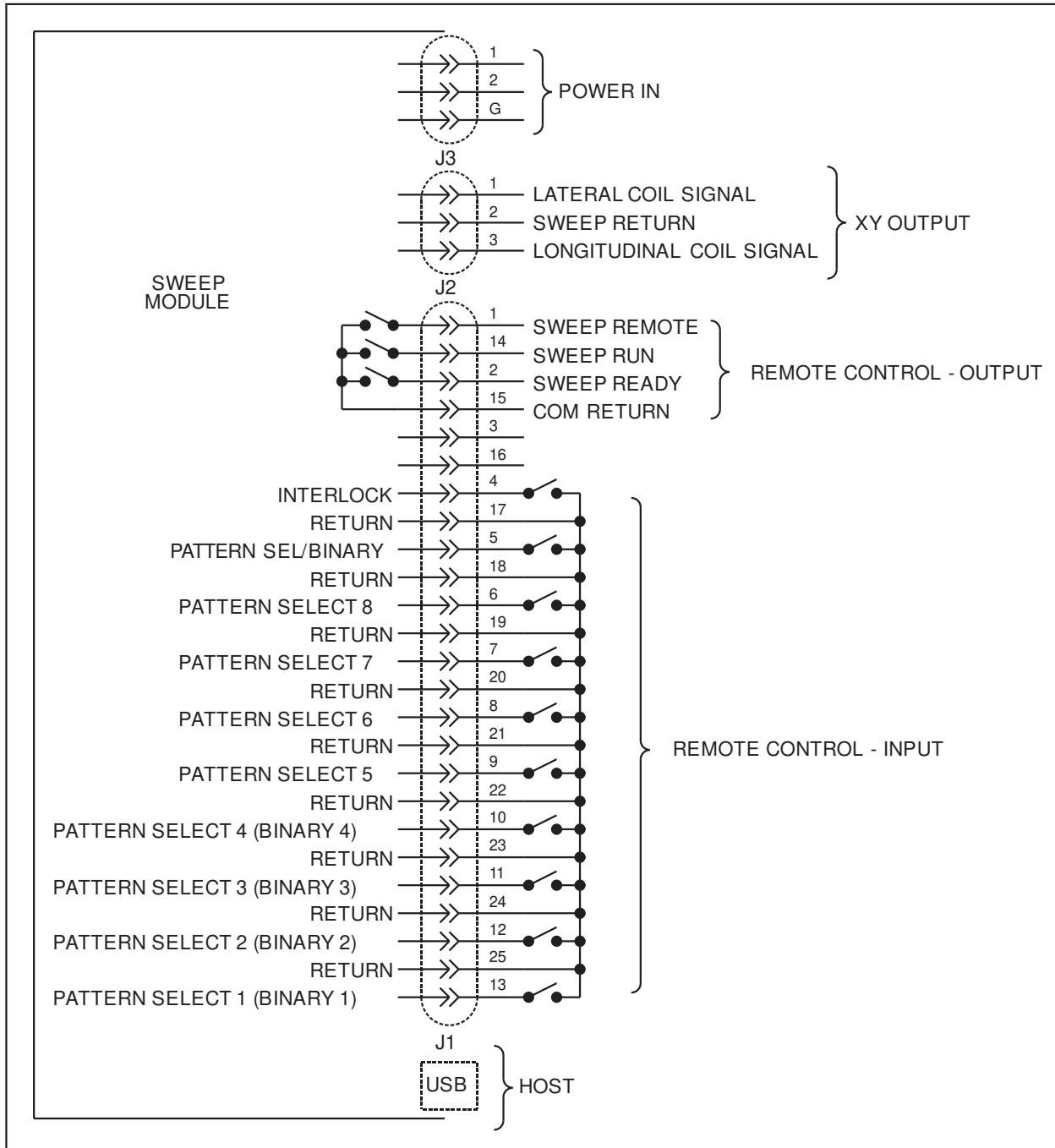

Figure 3-5, Connections

3.4.5 Remote Control - J2

The outputs are on a 25-pin male connector on the back of the controller, isolated SPST relays, 50VDC max, 2A max.

Pin outs and functions description:

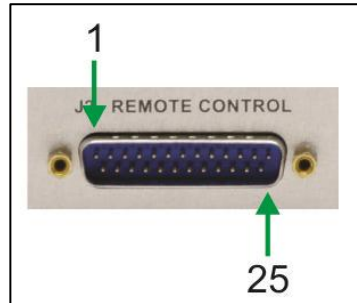

Figure 3-6, Dsub25 pinouts

Remote Control Input

Interlock – these pins need to be closed for the sweep output to operate. If these are not close a red INT will show in the upper left of the screen

Pattern Select – When in Remote mode and a signal has selected a pattern, that pattern will run. If no valid pattern is selected, then no pattern is output. The Run LED and the Remote LED will light up when the pattern is being output to the EB Source coils.

A pattern number may be selected two different ways. When pins 17 and 5 are open the pattern is selected by a Pattern Select pin being closed (contact closed). When pins 17 and 5 are closed then a pattern is selected by Binary code input on pins 10, 11, 12, and 13. See table for binary code input (0 = open, 1 = closed).

Note: Inputs are contact closure to sweep reference. Input voltages greater than 5VDC may damage the Digital Sweep.

Pattern	Binary			
	4 (J2-10)	3 (J2-11)	2 (J2-12)	1 (J2-13)
1	0	0	0	1
2	0	0	1	0
3	0	0	1	1
4	0	1	0	0
5	0	1	0	1
6	0	1	1	0
7	0	1	1	1
8	1	0	0	0

Remote Control Output (50V maximum compliant)

Outputs are a contact closure (dry contacts) inside the Digital Sweep.

Sweep Remote – A signal is sent out when the user has put the Digital Sweep in remote mode.

Sweep Run – A signal is sent out when there is output going to the EB source coils.

Sweep Ready – A signal is sent out when the Digital Sweep is ready and operational.

3.4.6 Host – J1

The host port is for upgrading the sweep software. **IF J1 IS CONNECTED TO A PC THE DIGITAL SWEEP WILL AUTOMATICLY GO IN TO DOWNLOAD MODE.**



Figure 3-7, Host Port

3.4.7 Output - J3

Connection of the sweep generator to the EB Source is shown in Figure 3-D, 3-E, 3-F, 3-G or 3-H. The horizontal and lateral coils should be brought out of the tank by way of a feedthrough and connected to pins 1, 2, 3 of J3 on the Sweep Module as shown. The interconnecting wire must be capable of passing a minimum of two amperes. The return wire is shared by both longitudinal and lateral coils. The sweep voltage is grounded inside the sweeper. However, you should connect the return wire to ground at the EB source end. To leave the return wire ungrounded could damage the sweeper. Normally one side of each coil is connected to ground at the electron beam source. The return wire is connected to the same spot inside the tank.

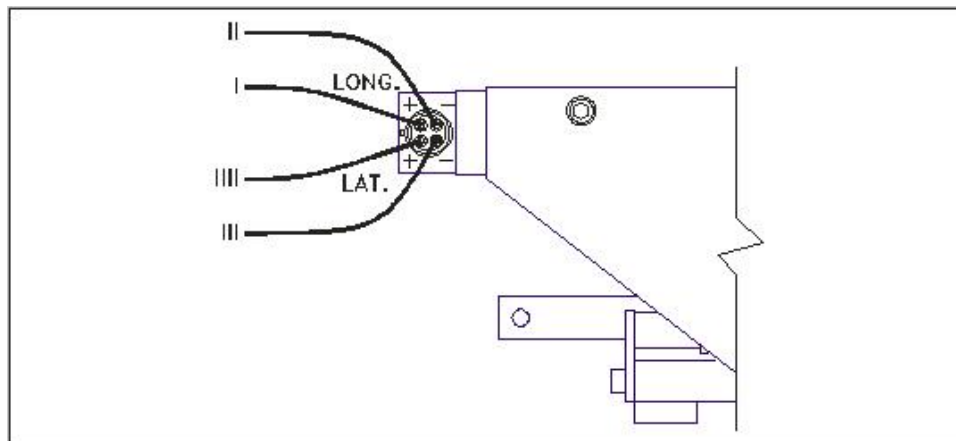

Figure 3-8, Telemark standard Coil Wire Reference Code

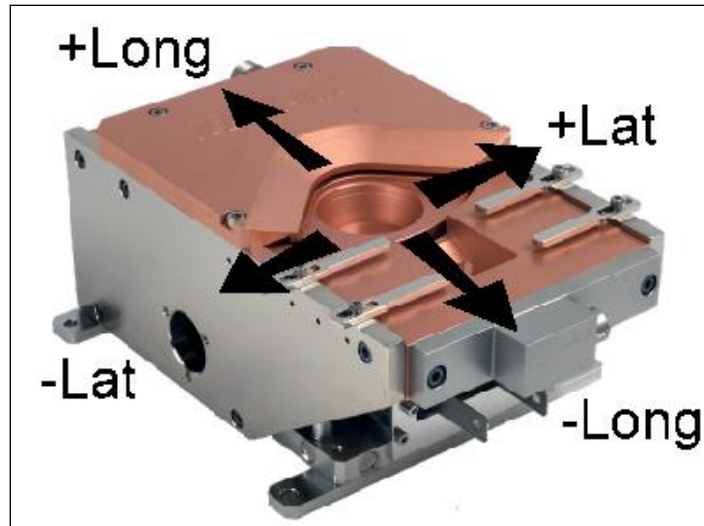

Figure 3-9, Telemark Source Standard Direction Reference

Note: the EB source Latitude and longitude coils can be connected in any manner needed to change the preferred viewing orientation as long as the Sweep Return is connected to ground.

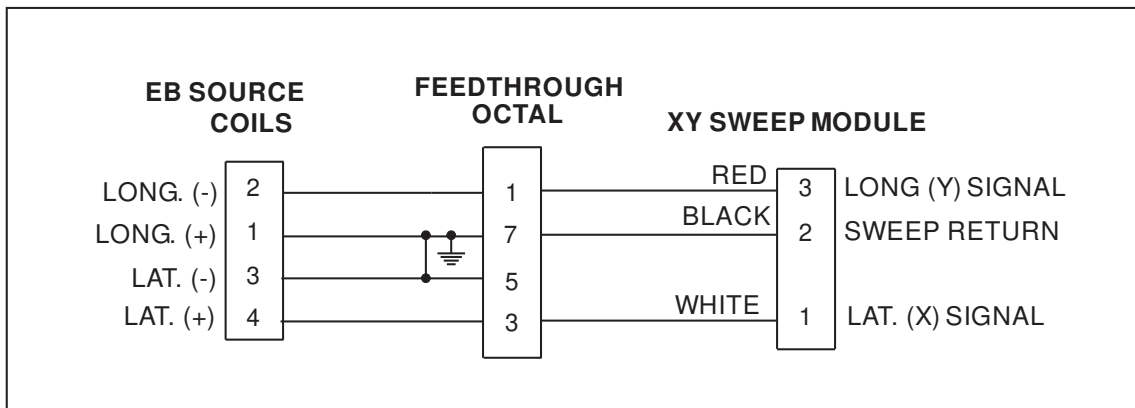

Figure 3-10, Typical 8 pin Sweep/coil Installation

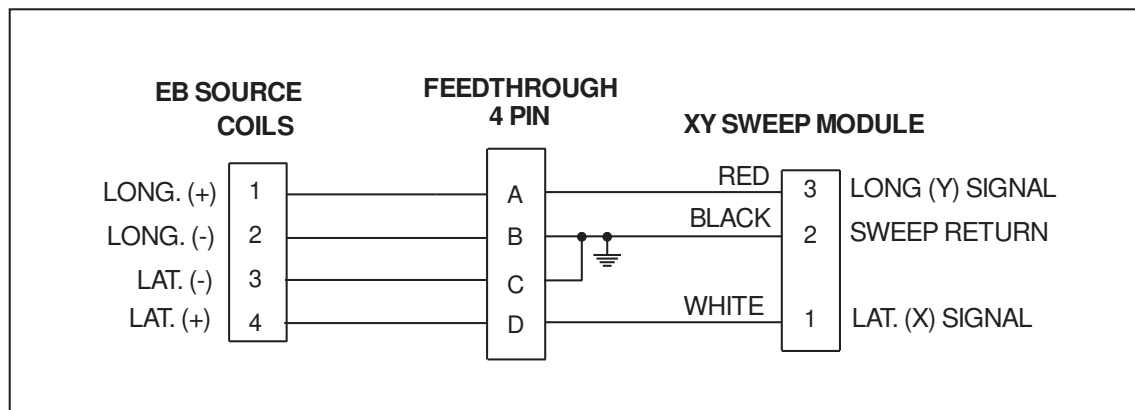

Figure 3-11, Typical 4 Pin Sweep/coil Installation



Improper connection.

In the case of incorrect connection - in accordance with Figure 3-8, 3-10, and 3-11 there is a danger of damage to the controller

3.5 List of Accessories or Supplies

Recommended parts:

8 pin feedthrough or 4 pin feedthrough

4 USING THE DIGITAL SWEEP

4.1 Front Panel

Please refer to Fig. 4-1 for front panel details

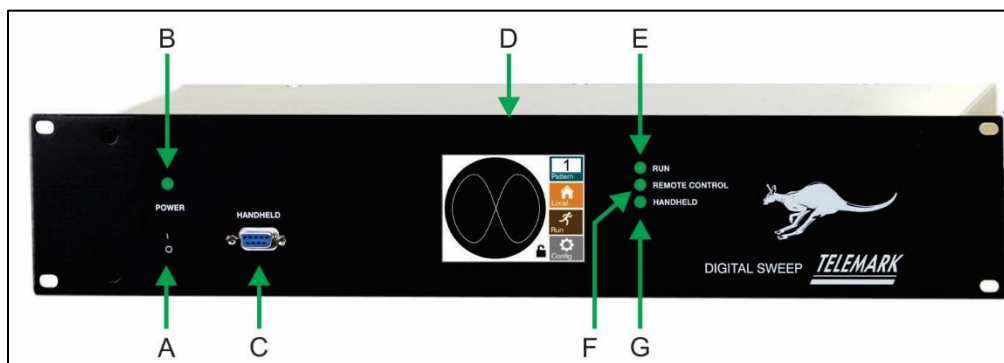

Figure 4-1 - Front Panel

- A – **POWER SWITCH** (see chapter 4.1.1 for details)
- B - **Power On LED** indicator (see chapter 4.1.2 for details)
- C - **HANDHELD** (see chapter 4.1.3 for details)
- D - **LCD touch screen** (see chapter 4.1.4 for details)
- E - **LED, RUN** (see chapter 4.1.5 for details)
- F - **LED, REMOTE CONTROL** (see chapter 4.1.6 for details)
- G - **LED, HANDHELD** (see chapter 4.1.7 for details)

4.1.1 Main Power Switch

Switching On the power button (position 'I') activates the main power circuit of the device. Switching off the unit (position 'O' switch) completely cuts the power to the internal circuits - controller is safe to make rear panel connections.



Risk of the electric shock!

All connection to the devices may only be carried out with the unit is turned off - the main power switch in 'O' position.

Failure to do so may cause electric shock

4.1.2 Power On LED indicator

Green LED indicates the unit power is on.

4.1.3 Handheld

The handheld Joystick can be plugged in or unplug at any time.

4.1.4 LCD Touchscreen

Interaction with the user takes place by means of a graphical LCD Touchscreen display. The screen can be set to turn off using the screen saver setting, The Sweep is always operational if the power is on even if the screen is off. Touch the screen to wake screen up.

4.1.5 LED, RUN

This LED lights up if sweep is running a pattern.

4.1.6 LED, REMOTE CONTROL

This LED lights up if unit is being controlled by a remote PLC through J2 on the back panel.

4.1.7 LED, HANDHELD

This LED lights up if joystick is plugged in and operational

4.2 Avatar Handheld

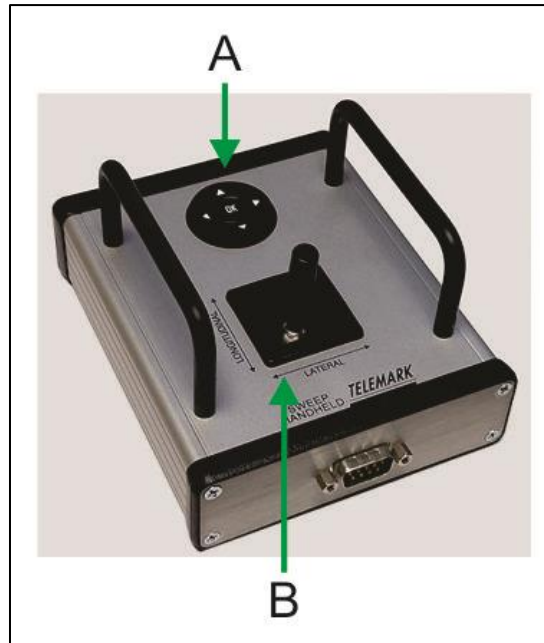

Figure 4-2, Avatar Sweep Handheld

A – **FOUR-WAY SWITCH** (see chapter 4.2.1 for details)

B – **JOYSTICK** (see chapter 4.2.2 for details)

4.2.1 Four-way and OK Momentary switch

- 1 Pocket Location/Size Setup** – The joystick is used to set the center and diameter of the pocket, see configuration chapter for more information.
- 2 Pocket Pattern Setup** – The joystick can be used to set the sweep Frequency and Amplitude for each pocket, see configuration chapter for more information.

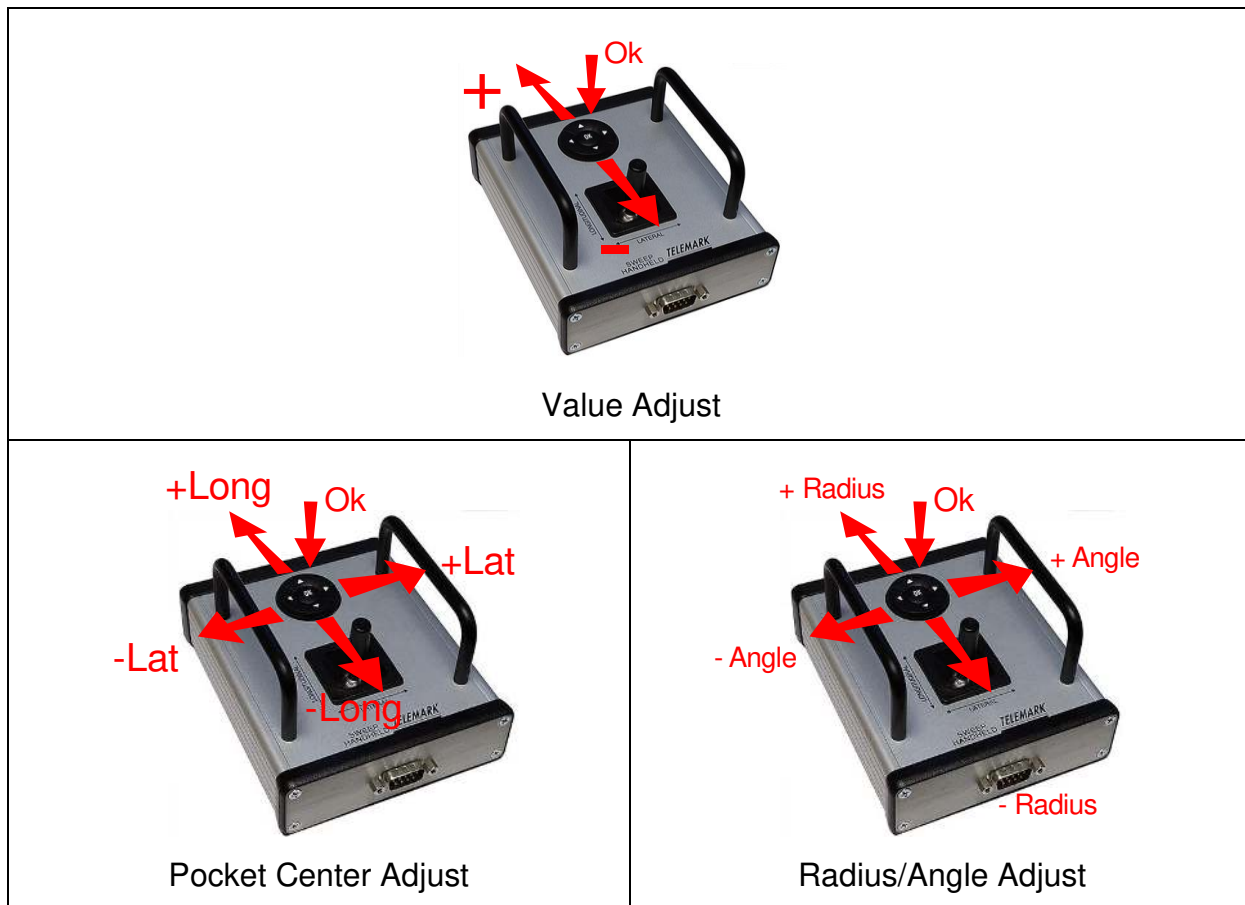

Figure 4-3, Four way and OK switch Operation

When the remote is plugged in it can function in three ways depending on the state of the screen.

Value Adjust –The Ok button switches the between variables. The Red button is the active variable. Up increases the value and down decrease the value of the button indicated in red.

Pocket Center Adjust – moves the center position in lateral and longitudinal directions. The Ok button cycles between pocket center and the eight radial adjustment points.

Radius/Angle Adjust – changes pocket point radius and deviation angle +/-22 degrees. The Ok button cycles between pocket center and the eight radial adjustment points.

4.2.2 Joystick

The joystick controls the latitudinal and longitudinal beam position.

- 1 Run Off Mode** – The joystick directly controls the e-beam output position, allowing the user to precondition the material manually. The Joystick lever controls direction of beam: left [-] & right [+] controls the lateral direction; near [-] (as seen from the EB source emitter) & far [+] controls the longitudinal direction.

- 2 Pattern Shift** – The joystick is used to move the center of the pattern in run mode, see operation chapter for more information.

5 CONFIGURATION

5.1 Unlocking

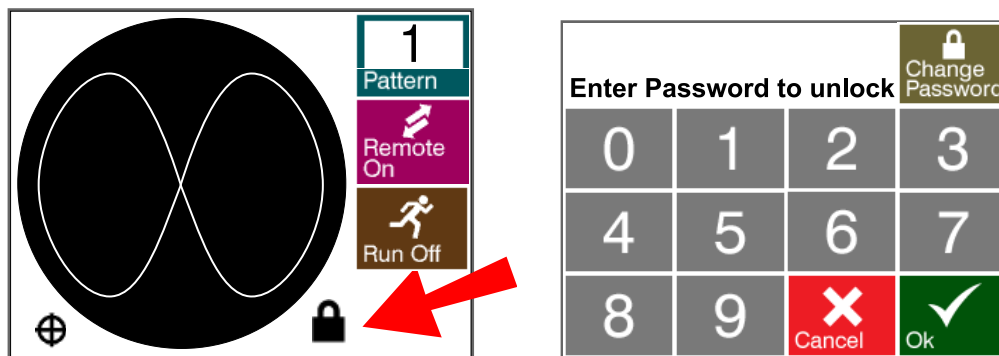

Figure 5-1, Unlocking Screen

To configure the Sweep first it must be unlocked. Press the lock to unlock the Sweep and enter the password.

The default password is "1234". The password can be changed at this time by pressing the **Change Password** button. Once the Sweep is unlocked it will stay unlocked until it is locked by pressing the **lock** or by turning the power off.

5.2 Configure Pocket Setup

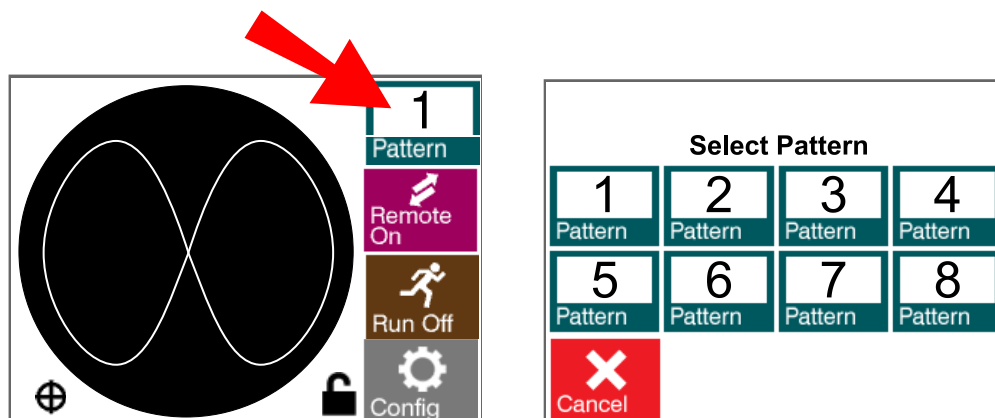

Figure 5-2, Configure Pocket Setup

Press the **Pattern** button to select the pattern to configure.

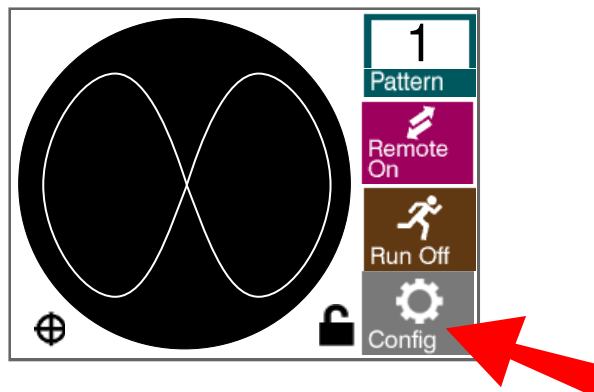

Figure 5-3, Pattern Button

Once the sweep is unlocked then the **Config** (Configure) button can be pressed.

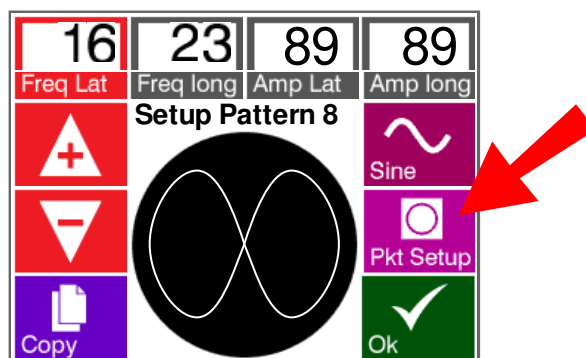

Figure 5-4, Pocket Setup Button

Select the **Pocket Setup**

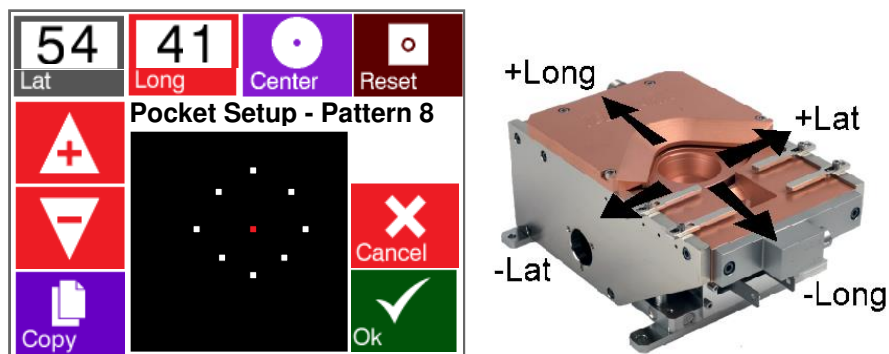

Figure 5-5, Pocket Setup, Center

First set the pocket center point. With the e-beam source running at low power and looking at the pocket, observe the beam and position the beam in the center of the pocket using the handheld joystick or touchscreen to control the latitudinal/ longitudinal position. Moving the center point moves all 9 points.

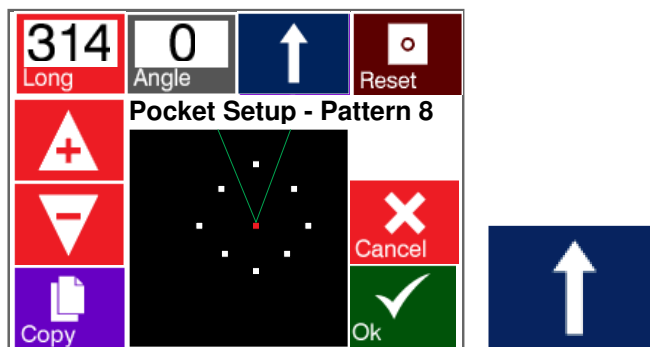

Figure 5-6, Pocket Setup, Direction

Next set the limits of the pocket with the 8 limit points. The limit points can be selected by pressing the blue arrow button to cycle around the 8 directions. Each time you press the blue direction arrow the sweep will switch to the next setup point. Two green lines are drawn to show the available area. First adjust the distance from center with the radius value. If you need to make a rotational adjustment use the angle adjustment to move +/-22 degrees. When you are satisfied with all five points then push the **Ok** button (Press Cancel to not save changes to pocket setup).

Once the center and limits have been set it is a good idea to make a note of the settings. The **Reset** button will reset all values of the current pocket setup to their minimums. There is a confirmation screen to prevent accidental resetting. The black box is the usable area that defines the maximum output of 1.6.

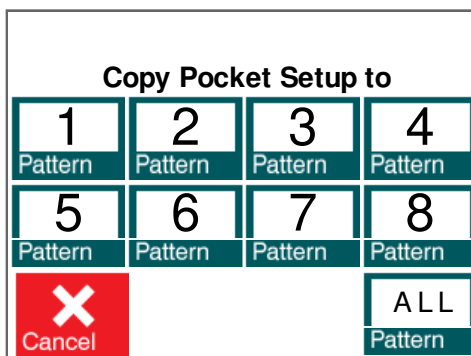

Figure 5-7, Copy Pocket Setup

The pocket setup can be copied to other patterns. Normally copying to ALL patterns would be desirable if the pockets in the e-beam source are the same size.

5.3 Configure Pattern

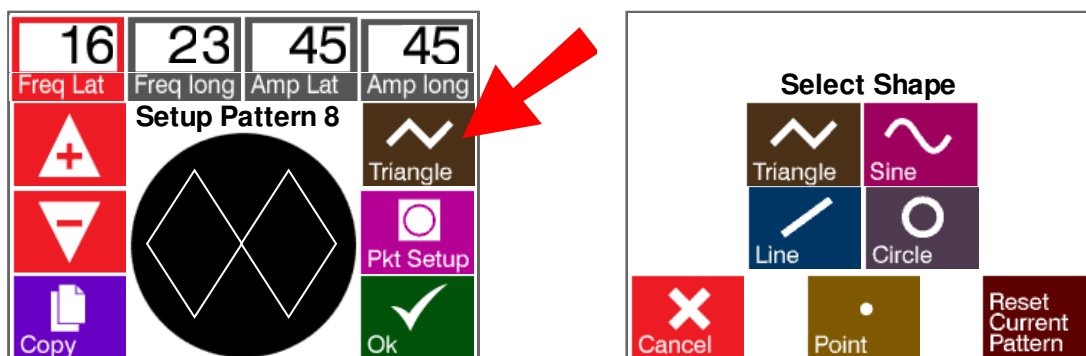

Figure 5-8, Configure Pattern

First, select the shape type, **Triangle**, **Line**, **Circle**, **Sine** or **Point** by touching the Shape button. The **Reset Current Pattern** button will reset the current pattern settings for all shapes to factory defaults.

Adjust the Frequencies and Amplitudes using the + and – arrows on the touch screen or use the joystick remote, up is + and down is –. Red highlight indicates the box with the parameter to be adjusted. Click on the remote to switch to adjust the other values or touch on the touchscreen. Latitudinal and longitudinal frequencies are adjustable from 0.5Hz to 100Hz and Collapse and Rotate frequencies are adjustable from 0 to 5Hz.

5.3.1 Sine

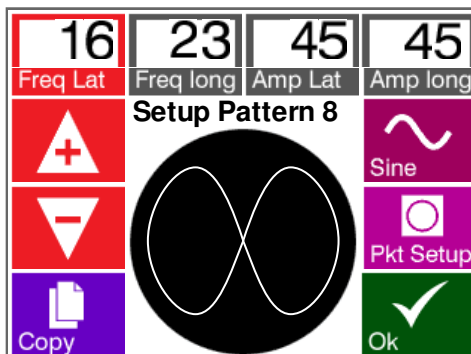

Figure 5-9, Setup Pattern, Sine

Freq Lat – Frequency Latitudinal 0.5Hz to 100Hz

Freq Long – Frequency Longitudinal, 0.5Hz to 100Hz

Amp Lat – Amplitude Latitudinal, 25-100% of configured maxim pocket

Amp Long - Amplitude Longitudinal, 25-100% of configured maxim pocket

5.3.2 Triangle

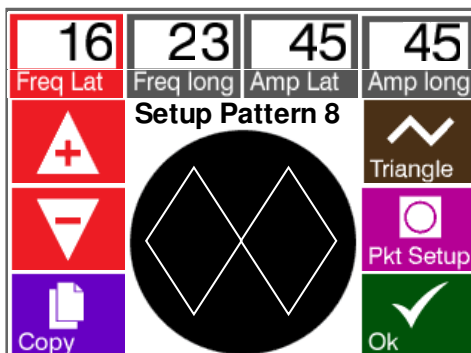

Figure 5-10, Setup Pattern, Triangle

Freq Lat – Frequency Latitudinal, 0.5Hz to 100Hz

Freq Long – Frequency Longitudinal, 0.5Hz to 100Hz

Amp Lat – Amplitude Latitudinal, 25-100% of configured maxim pocket

Amp Long - Amplitude Longitudinal, 25-100% of configured maxim pocket

5.3.3 Circle

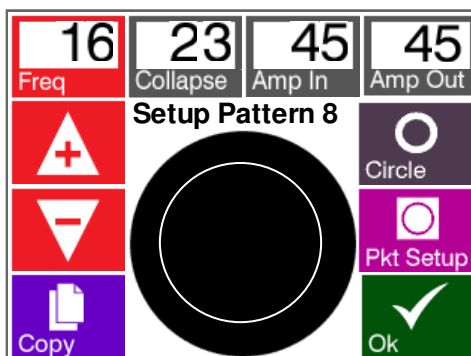

Figure 5-11, Setup Pattern, Circle

Freq – Frequency, 0.5Hz to 100Hz

Collapse - Collapse, 0 to 5Hz. (if collapse is 0 then the Amp In is not visible)

Amp In – Amplitude In, 5-100% of configured maxim pocket (only when the collapse greater than 0)

Amp Out – Amplitude Out, 10-100% of configured maxim pocket

5.3.4 Line

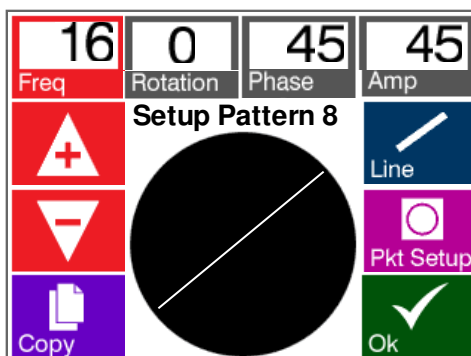

Figure 5-12, Setup Pattern, Line

Freq – Frequency, 0.5Hz to 100Hz

Rotation – Rotation of the line, 0 to 20Hz.

Phase – Controls the angle of the line (only visible when the rotation is 0), 0 to 179

Amp – Amplitude, 25-100% of configured maxim pocket

5.3.5 Point

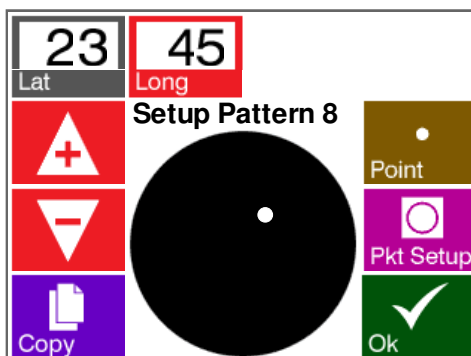

Figure 5-13, Setup Pattern, Point

The point pattern is a fixed point and location is a special case. The lat and long numbers displayed are the absolute location numbers. A maximum of 97% of configured pocket maximum in any direction is designed to prevent users from damaging the e-beam source pocket.

Lat – Latitudinal position, -511 to +511 (-97% to +97% of configured pocket maximum)

Long – Longitudinal position, -511 to +511 (-97% to +97% of configured pocket maximum)

5.4 Display Tail Length

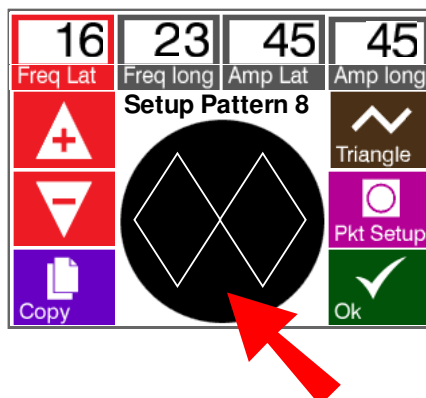

Figure 5-14, Display Tail Length

The pattern on the LCD screen maybe difficult to see depending on the Shape, Frequency, and Amplitude of the pattern. Adjusting the LCD Tail Length can improve the visibility of the pattern. This adjustment can be accessed by pressing anywhere on the pattern display area.

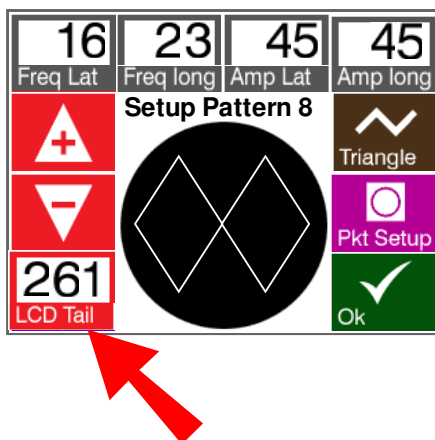

Figure 5-15, Display Tail Length Adjustment

Changing the LCD Tail length (10-300) makes the display of the pattern more or less visible. Note: the LCD Tail length has no effect on the actual output to the EB source.

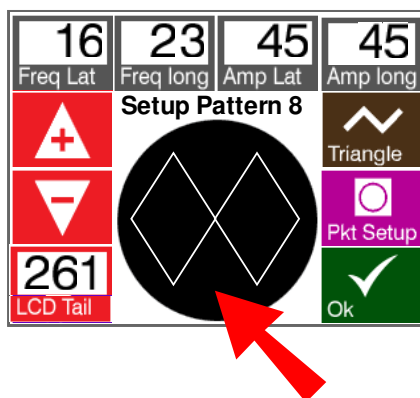

Figure 5-16, Display Tail Length Hide

Press on the display area Hide LCD Tail adjustment.

6 OPERATION

6.1 General Operation

6.1.1 Power-Up

When the front-panel **POWER** switch is turned on, the fans turn on and the LCD lights and displays the version of the software for 3 seconds then displays the operational screen shown below.

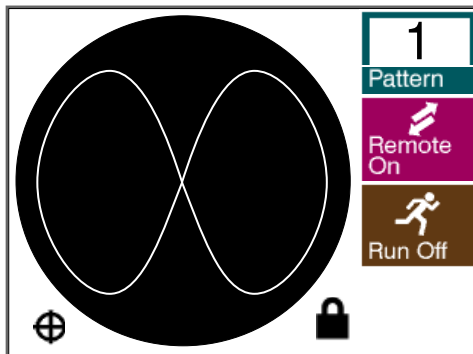

Figure 6-1, Touchscreen Display

Then turn on the power supply HV & Emission. Set the Hi-Voltage at the level necessary for the material, but set the Emission very low, just enough to barely see a beam. This way the sweep pattern settings can be judged and finalized without affecting the material.

6.1.2 Power-Down

When the front-panel **POWER** switch is turned off, all lights and outputs go off. All patterns are stored in memory; last pattern used will be the current selection when the unit is turned back on.

6.2 Pattern Selection

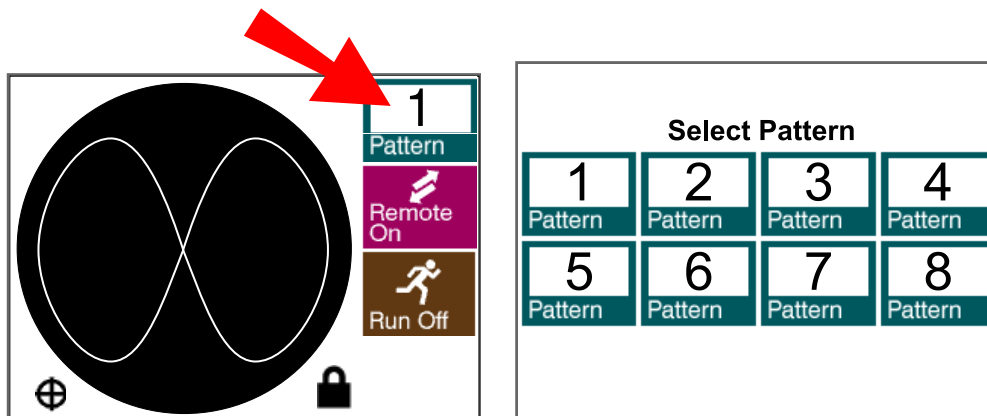

Figure 6-2, Pattern Selection

Press the **Pattern** button to get the Select Pattern menu.

6.3 Move Pattern

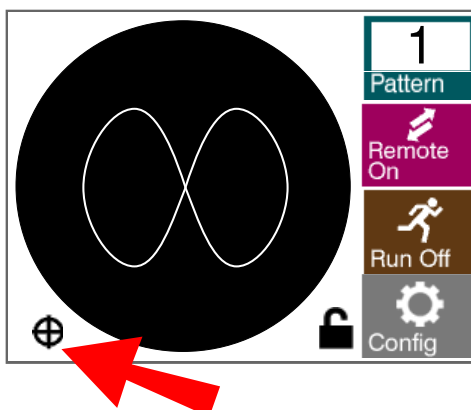

Figure 6-3, Select Pattern Move

Patterns can be moved in the pocket by pressing the Pattern Move icon

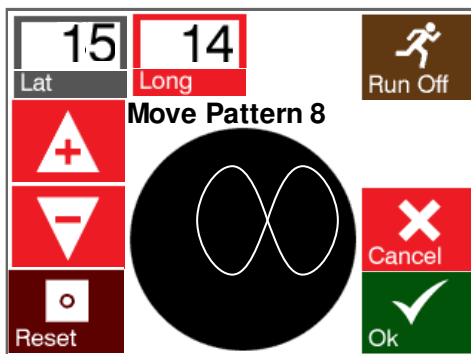

Figure 6-4, Move Pattern

Latitude and longitude can be adjusted with the + and – arrows or with the joystick. The pattern can only be moved to the edge of the pocket. In **Locked** mode the new location

will be stored until the Digital Sweep power is turned off. In **Unlocked** mode the new location will be stored in permanent memory till it is reset or changed. The Reset button will reset Latitude and longitude to 0. If the pattern is changed in configuration mode and the shape exceeds the pocket limit the pattern shift will be reset to 0. Also, any changes to the pocket limit will reset the pattern shift to 0.

6.4 Run On/Off

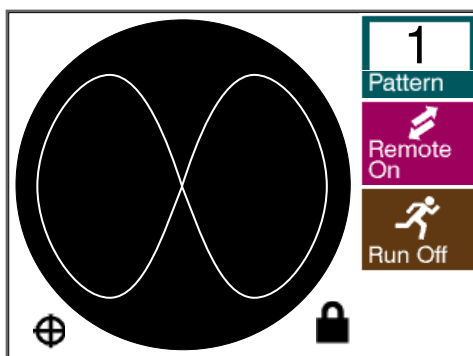

Figure 6-5, Run On Mode

When in **Run On** mode the pattern that has been selected the Select Pattern menu is output.

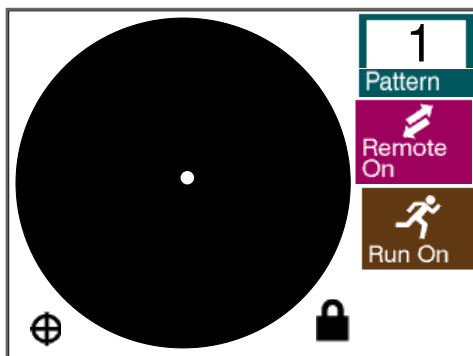

Figure 6-6, Run Off Mode

When in **Run Off** mode the joystick directly controls the e-beam output position, allowing the user to precondition the material manually. The Joystick lever controls direction of beam: left [-] & right [+] controls the lateral direction; near [-] (as seen from the EB source emitter) & far [+] controls the longitudinal direction.

6.5 Remote On/Off

Remote button toggles between on and off. **Remote On** allows control from a PLC using the remote-control input on J2 on the back panel. When remote is **on** the operator can only turn it off, all other operations are disabled. **Remote On** gives full control to the remote and lights up the Remote LED on the front panel.

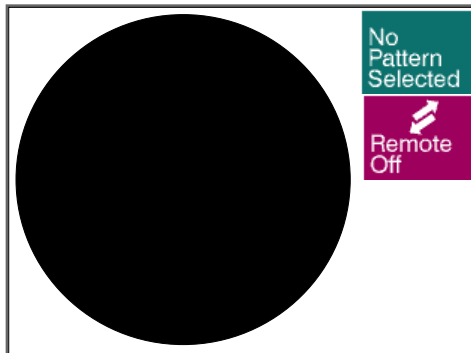

Figure 6-7, No Pattern Selected

If no pattern is selected by the remote, then **No Pattern Selected** is shown and there is no output to the coils

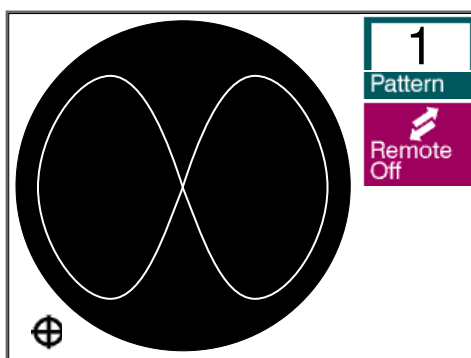

Figure 6-8, Remoted Pattern Selected

If a valid pattern is selected by the remote (contact closed) then that pattern and pattern number will be displayed, the Run LED will light up and the pattern is output to the coils.

7 MAINTENANCE AND SERVICE

7.1 Maintenance

The Sweep does not require any special maintenance.

7.2 Cleaning

For cleaning the outside of the device, a slightly moistened cloth will usually do. Do not use any aggressive or abrasive cleaning agents.



Mains voltage.

Components inside of the Sweep controller are components to mains voltage.

Protect the device from liquids.

Do not open the device.

8 STORAGE AND DISPOSAL

8.1 Packaging

Please keep the original packaging. The packaging is required for storing the Sweep and for shipping it to a Telemark service center.

8.2 Storage

The Sweep may only be stored in a dry room. The following requirements must be met:

Ambient temperature: -20...+60 °C

Humidity: as low as possible. Preferably in an air-tight plastic bag with a desiccant.

8.3 Disposal

The product must be disposed of in accordance with the relevant local regulations for the environmentally safe disposal of systems and electronic components.

8.4 WEEE

The use of the Waste Electrical and Electronic Equipment (WEEE) symbol (see Figure 8-1) indicates that this product may not be treated as household waste. By ensuring this product is disposed of correctly you will protect the environment. Recycling information of this product can be obtained at the place of sale, your household waste disposal service provider, or local authority.



Figure 8-1, WEEE Symbol

9 ERRORS AND WARNINGS

9.1 Error Codes

The Digital Sweep checks at start up and continually when it is turn on for any errors, if an error is found the sweep output is stopped and **Remote** mode it turned off. The error conditions must be fixed before the Digital Sweep will be operational. Errors may be with the Digital Sweep, the EB source coils, or the connection between the two. The possible error codes are shown below:

- +24V failure on Latitude driver
- 24V failure on Latitude driver
- +24V failure on Longitude driver
- 24V failure on Longitude driver
- EEPROM failure - no acknowledge
- EEPROM failure - invalid product code
- EEPROM failure - write verify

9.2 Interlock Fail

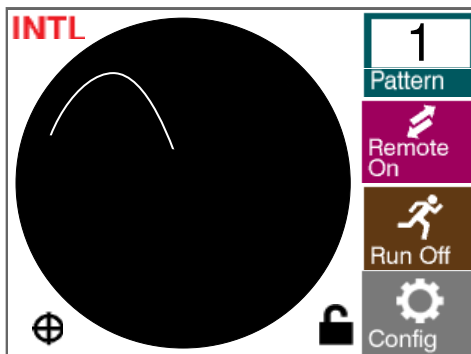

Figure 9-1, Interlock Fail

When the interlock string is broken a red "INTL" will show in the upper left corner of the screen, the pattern will stop on the screen and the output to the EB sources will stop.

10 WARRANTY CONDITIONS

10.1 Limited Warranty

The Electron Beam Source Digital Sweep is guaranteed against faulty materials, function and workmanship for a period of 12 months after delivery from Telemark. Components which are purchased by Telemark from other manufacturers will be guaranteed for any lesser time that such manufacturer warrants its products to Telemark. This warranty is valid only for normal use where regular maintenance is performed as instructed. This warranty shall not apply if repair has been performed or an alteration made by anyone other than an authorized Telemark representative or if a malfunction occurs through abuse, misuse, negligence or accident. No charge will be made for repairs made under warranty at Telemark's facilities. Freight costs both ways will be at customer's expense. Telemark reserves the right for final warranty adjustment.