



# MODEL 861 DEPOSITION CONTROLLER

## INSTRUCTION MANUAL



Copyright © TELEMARK, 1995-2020 – All rights reserved

Manual Rev 1.0.0 June 2020

[telemark.com](http://telemark.com)

This manual is for software version 2.5.0 and above.  
Current interface and software options might be different. Contact manufacturer for current manual release if the software interface or functions are different from this manual or download the current version of this manual at

<https://telemark.com/quartz-crystal-control/861-deposition-controller/>

Brand and product names are trademarks or registered trademarks of their respective companies

# TABLE OF CONTENTS

<b>1</b>	<b>INTRODUCTION.....</b>	<b>13</b>
1.1	INTENDED USE .....	13
1.2	LIABILITIES AND WARRANTY .....	13
1.3	SAFETY .....	14
1.3.1	Personnel Qualifications .....	14
1.3.2	Illustration of Residual Dangers .....	14
1.4	GENERAL SAFETY INSTRUCTIONS .....	15
1.5	SOFTWARE.....	16
<b>2</b>	<b>TECHNICAL DATA.....</b>	<b>17</b>
2.1	GENERAL DATA .....	17
2.1.1	Mechanical Data .....	17
2.1.2	Ambience .....	18
2.1.3	Use and Operating Modes .....	18
2.1.4	Standards.....	19
2.2	MAINS CONNECTION.....	19
2.3	PACK LIST.....	20
2.3.1	Standard Items.....	20
2.3.2	Optional Items.....	23
2.4	SPECIFICATIONS .....	25
2.4.1	Measurement .....	25
2.4.2	Display .....	25
2.4.3	Communication .....	25
2.4.4	Program Storage Capacity.....	25
2.4.5	Process Parameters.....	25
2.4.6	Material Parameters.....	26
2.4.7	Input/Output Capability .....	27
2.4.8	Source/Sensor Capability .....	27
2.4.9	Oscillator Capability .....	27
2.4.10	Sensor Parameters .....	27
2.4.11	Source Parameters .....	28
2.4.12	DAC.....	28
2.4.13	Utility Parameters.....	28
2.4.14	Display Parameters.....	29
2.5	FEATURES .....	29
2.6	INTERFACES .....	29

2.6.1	Input Interface .....	29
<b>3</b>	<b>INSTALLATION.....</b>	<b>30</b>
3.1	UNPACKING.....	30
3.2	MECHANICAL INSTALLATION .....	30
3.2.1	Required components .....	31
3.3	INSTALLATION.....	31
3.3.1	Rack Installation.....	31
3.4	CONTROLLER CONNECTING.....	32
3.4.1	Front Panel.....	32
3.4.2	Rear Panel .....	33
3.4.3	Mains Connection .....	34
3.4.4	Grounding .....	35
3.4.5	RS-232 .....	35
3.4.6	Ethernet.....	35
3.4.7	Source-Sensor .....	36
3.4.8	Discrete Input, 25 Pin.....	37
3.4.9	Discrete Output, 25 Pin .....	40
3.4.10	Input/Output, 37 Pin .....	41
3.5	INSTALLING ADDITIONAL BOARDS.....	44
3.5.1	Source-Sensor Board.....	44
3.5.2	Discrete I/O Board.....	44
3.6	SENSOR HEAD INSTALLATION.....	44
3.7	SENSOR OSCILLATOR .....	45
3.8	OSCILLATOR TEST .....	46
3.9	INSTRUMENTATION FEEDTHROUGH .....	46
3.10	SENSOR CRYSTAL REPLACEMENT .....	46
3.11	REMOTE CONTROL .....	47
<b>4</b>	<b>USING THE 861.....</b>	<b>48</b>
4.1	FRONT PANEL .....	48
4.1.1	Main Power Switch.....	48
4.1.2	Power On LED indicator .....	49
4.1.3	Handheld .....	49
4.1.4	USB.....	49
4.1.5	LCD Touchscreen .....	49
4.2	HANDHELD .....	49

4.3	TOUCH SCREEN OPERATION .....	50
4.3.1	Program Menu .....	50
4.3.2	Results .....	50
4.3.3	USB .....	51
4.3.4	Right Side Bar Buttons .....	54
4.3.5	Entering Alpha Characters .....	55
4.3.6	Copying, Deleting and Moving .....	55
<b>5</b>	<b>CONFIGURATION .....</b>	<b>57</b>
5.1	GETTING STARTED .....	57
5.2	SETUP .....	58
5.2.1	Display .....	58
5.2.2	Utility .....	61
5.2.3	Sensor .....	63
5.2.4	Source .....	66
5.2.5	DAC .....	69
5.2.6	Inputs .....	70
5.2.7	Outputs .....	72
5.2.8	Actions .....	75
5.3	MATERIAL .....	77
5.3.1	Define A Material .....	77
5.4	PROCESS .....	85
5.4.1	Define A Process .....	86
<b>6</b>	<b>OPERATION .....</b>	<b>88</b>
6.1	INITIAL POWER UP .....	88
6.2	DISPLAYS .....	89
6.2.1	Rate .....	89
6.2.2	Power .....	89
6.2.3	Thickness .....	89
6.2.4	PROCESS NAME and LAYER NUMBER .....	90
6.2.5	Film Number .....	90
6.2.6	System Status .....	90
6.2.7	Source Number .....	90
6.2.8	Pocket Number .....	90
6.2.9	Material Name .....	90
6.2.10	Sensor Number .....	90
6.2.11	Crystal Health % .....	91
6.2.12	Time To Go .....	91
6.3	OPERATING CONTROLS .....	91
6.3.1	Manual Button .....	91

6.3.2	Start Button .....	91
6.3.3	Abort Button .....	92
6.3.4	Reset Button .....	92
6.3.5	Zero Button .....	92
6.3.6	Shutter Button .....	92
6.4	SIDE BAR CONTROLS .....	92
6.4.1	Status Button.....	92
6.4.2	Program Button.....	93
6.5	MANUAL POWER HANDHELD .....	93
6.6	SIMULATE OPERATION .....	93
6.7	STARTING A PROCESS .....	94
6.8	STARTING A NEW LAYER.....	94
6.9	RESUMING AN ABORTED OR HALTED PROCESS.....	94
6.10	STATUS DISPLAYS .....	95
6.11	MODES.....	96
6.11.1	Ready.....	96
6.11.2	Abort.....	97
6.11.3	In Process .....	97
6.11.4	Not Sampling.....	97
6.11.5	Process Complete.....	97
6.11.6	Manual .....	97
6.11.7	Simulate .....	97
6.12	STATES.....	97
6.13	ERROR, WARNING, AND INFORMATION MESSAGES .....	98
6.13.1	Description .....	99
6.13.2	Min Rate & Max Power .....	99
6.13.3	Max Rate & Min Power .....	99
6.13.4	Rate Est. Error .....	99
6.13.5	Crystal Failure .....	99
6.13.6	Time Power .....	100
6.13.7	Rate Dev. Alarm.....	100
6.13.8	Alarm Action.....	100
6.13.9	Crystal Marginal .....	100
6.13.10	Rate Dev. Alert.....	100
6.13.11	Max Power Alert.....	100
6.13.12	Min Power Alert.....	100
6.13.13	Alert Action.....	100
6.13.14	Xtal Fail Switch.....	100
6.13.15	Xtal Mrgn Switch .....	100

6.13.16 Rate Dev. Atten.....	101
6.13.17 Maximum Power .....	101
6.13.18 Minimum Power .....	101
6.13.19 Change Pocket.....	101
6.13.20 Change Crystal .....	101
6.13.21 Attention Action.....	101
<b>7 TUNING .....</b>	<b>102</b>
7.1 ESTABLISHING 861 CONTROL LOOP PARAMETERS .....	102
7.2 EMPIRICAL CALIBRATION .....	103
7.2.1 Film Density .....	104
7.2.2 Tooling Factor .....	104
7.2.3 Acoustic Impedance.....	104
<b>8 THEORY OF OPERATION .....</b>	<b>106</b>
8.1 BASIC MEASUREMENT.....	106
8.2 CRYSTAL HEALTH CALCULATION .....	106
8.3 RATE CALCULATION .....	106
8.4 RATE CONTROL .....	107
8.5 EMPIRICAL CALIBRATION .....	107
8.5.1 Film Density .....	107
8.5.2 Tooling Factor .....	108
8.5.3 Acoustic Impedance.....	108
<b>9 STANDARD INTERFACE.....</b>	<b>109</b>
9.1 GENERAL .....	109
9.2 RS-232 SERIAL INTERFACE .....	109
9.3 ETHERNET INTERFACE.....	110
9.4 PROTOCOL .....	110
9.5 DATA TYPES.....	111
9.6 MESSAGE RECEIVED STATUS .....	111
9.7 DEBUG COMPUTER INTERFACE.....	112
9.8 INSTRUCTION SUMMARY .....	112
9.9 INSTRUCTION DESCRIPTIONS - STANDARD .....	113
9.9.1 Remote activation of controller (Code #100) .....	113
9.9.2 Send controller hardware configuration (Code #1) .....	114
9.9.3 Send a material (Code #106).....	115

9.9.4	Receive a material (Code #107) .....	116
9.9.5	Send material list (Code #108) .....	117
9.9.6	Send process (Code #110) .....	117
9.9.7	Receive process (Code #11) .....	118
9.9.8	Delete process (Code #12) .....	118
9.9.9	Send process layer (Code #13) .....	118
9.9.10	Insert process layer (Code #14) .....	119
9.9.11	Replace process layer (Code #115) .....	119
9.9.12	Delete process layer (Code #16) .....	119
9.9.13	Send a process list (Code #17) .....	120
9.9.14	Send controller status (Code #28) .....	120
9.9.15	Start process (Code #29) .....	122
9.9.16	Send run-time values (Code #30) .....	122
9.9.17	Initiate Automatic Data Logging (Code #31) .....	123
9.9.18	Send Process Log Directory (Code #36) .....	123
9.9.19	Send run-time values (Code #39) .....	124
9.9.20	Delete a material (Code #150) .....	125
9.9.21	Select Process (Code #151) .....	125
9.9.22	Query Numerical Value (Code #200) .....	125
9.10	INSTRUCTION DESCRIPTIONS – LEGACY CODES .....	125
9.10.1	Remote activation of controller (Code #0) .....	125
9.10.2	Send a material (Code #6) .....	126
9.10.3	Receive a material (Code #7) .....	127
9.10.4	Send material list (Code #8) .....	128
9.10.5	Send process (Code #10) .....	128
9.10.6	Replace process layer (Code #15) .....	129
<b>10</b>	<b>360C SERIAL INTERFACE .....</b>	<b>130</b>
10.1	GENERAL .....	130
10.2	RS-232 SERIAL INTERFACE .....	130
10.3	PROTOCOL .....	131
10.4	DATA TYPES .....	132
10.5	MESSAGE RECEIVED STATUS .....	132
10.6	DEBUG COMPUTER INTERFACE .....	133
10.7	INSTRUCTION SUMMARY .....	133
10.8	INSTRUCTION DESCRIPTIONS – 360C .....	134
10.8.1	Remote activation of controller (Code #0) .....	134
10.8.2	Send a material (Code #6) .....	134
10.8.3	Receive a material (Code #7) .....	137
10.8.4	Send material list (Code #8) .....	137

10.8.5	Send process (Code #10)	138
10.8.6	Receive process (Code #11)	138
10.8.7	Delete process (Code #12)	139
10.8.8	Send process layer (Code #13)	139
10.8.9	Insert process layer (Code #14)	140
10.8.10	Replace process layer (Code #15)	140
10.8.11	Delete process layer (Code #16)	140
10.8.12	Send a process list (Code #17)	141
10.8.13	Send controller status (Code #28)	141
10.8.14	Start process (Code #29)	143
10.8.15	Send run-time values (Code #30)	143
10.8.16	Send Process Log Directory (Code #36)	146
10.8.17	Delete a material (Code #150)	146
<b>11</b>	<b>ASCII SERIAL INTERFACE</b>	<b>148</b>
11.1	GENERAL	148
11.2	RS-232 SERIAL INTERFACE	148
11.3	ASCII PROTOCOL	148
11.4	LIST OF COMMANDS	149
11.5	ASCII CHECKSUM	149
11.6	ASCII NO CHECKSUM	149
11.7	ERROR CODES	150
11.8	DEBUG COMPUTER INTERFACE	150
11.9	INSTRUCTION SUMMARY	151
11.9.1	Echo	151
11.9.2	Hello	151
11.9.3	Query	151
11.10	UPDATE	153
11.11	STATUS	154
11.12	REMOTE	156
<b>12</b>	<b>MIXED ASCII INTERFACE</b>	<b>158</b>
12.1	GENERAL	158
12.2	RS-232 SERIAL INTERFACE	158
12.3	MIXED ASCII PROTOCOL	158
12.4	LIST OF COMMANDS	159



12.5	ASCII CHECKSUM PROTOCOL .....	159
12.5.1	Send.....	159
12.5.2	Response .....	159
12.5.3	Error Codes.....	160
12.5.4	Packet Error codes.....	160
12.5.5	Debug Computer Interface.....	161
12.6	INSTRUCTION SUMMARY .....	161
12.7	UPDATE.....	165
12.8	STATUS.....	165
12.9	REMOTE.....	167
<b>13</b>	<b>TROUBLE SHOOTING.....</b>	<b>169</b>
<b>14</b>	<b>MATERIAL TABLE.....</b>	<b>170</b>
<b>15</b>	<b>MAINTENANCE AND SERVICE.....</b>	<b>184</b>
15.1	MAINTENANCE .....	184
15.2	CLEANING.....	184
<b>16</b>	<b>STORAGE AND DISPOSAL.....</b>	<b>185</b>
16.1	PACKAGING.....	185
16.2	STORAGE.....	185
16.3	DISPOSAL .....	185
16.4	WEEE .....	185
<b>17</b>	<b>WARRANTY CONDITIONS .....</b>	<b>187</b>
17.1	LIMITED WARRANTY .....	187

## TABLE OF FIGURES

Figure 1-1, Keep Foreign Material Output of 861 .....	15
Figure 2-1, 861 Reference Dimensions .....	18
Figure 3-1, Front Panel Connection .....	32
Figure 3-2, 861 Manual Power Handheld .....	33
Figure 3-3, Rear panel 861 Controller .....	33
Figure 3-4, Three-conductor cable with protective ground (example) .....	34
Figure 3-5, RS-232 Connection .....	35
Figure 3-6, Ethernet Connection .....	36
Figure 3-7, Source-Sensor Card .....	36
Figure 3-8, Source Connection .....	37
Figure 3-9, 860 Source Adaptor Pin Out .....	37
Figure 3-10, 25 Pin Input Card .....	37
Figure 3-11, Active 25-Pin Input Card Connections .....	38
Figure 3-12, Passive 25-Pin Input Card Connections .....	39
Figure 3-13, 25-Pin Output Card .....	40
Figure 3-14, 25 Pin Output Card Connections .....	40
Figure 3-15, 37-Pin Input/Output Card .....	41
Figure 3-16, 37-Pin I/O Card, Active/Passive Jumpers .....	41
Figure 3-17, Active 37-Pin I/O Card Connections .....	42
Figure 3-18, Passive 37-Pin I/O Card Connections .....	43
Figure 3-19, Oscillator and Cables .....	45
Figure 3-20, Oscillator Test button .....	46
Figure 3-21, Frequency on Sensor Status screen .....	46
Figure 4-1, Front Panel .....	48
Figure 4-2, Manual Power Handheld .....	49
Figure 4-3, Program Menu .....	50
Figure 4-4, Results Screen .....	51
Figure 4-5, USB Menu screen .....	51
Figure 4-6, USB System Backup/Restore .....	52
Figure 4-7, USB Process/Material Backup/Restore .....	52
Figure 4-8, Copy 861 System Data to USB .....	53
Figure 4-9, Copy System Data from USB to 861 .....	53

Figure 4-10, Password screen .....54

Figure 4-11, Keyboard .....55

Figure 4-12, Copying and Deleting.....56

Figure 5-1, System Setup Menu screen .....57

Figure 5-2, Display Setup Screen.....58

Figure 5-3, VNC Waning Screen.....59

Figure 5-4, VNC Mode Screen .....59

Figure 5-5, TightVNC Connection in Windows .....59

Figure 5-6, Utility Setup screen .....61

Figure 5-7, Sensor Setup Screen.....64

Figure 5-8, Source Setup Screen.....66

Figure 5-9, DAC Setup screen .....69

Figure 5-10, DAC Rate and Thickness.....70

Figure 5-11, Program Inputs .....70

Figure 5-12, 25 pin Card, Passive/Active Setting .....71

Figure 5-13, Output screen .....72

Figure 5-14, Program Output Screen .....73

Figure 5-15, Program Output Screen .....73

Figure 5-16, Actions List .....76

Figure 5-17, Action Setup .....76

Figure 5-18, Action Selection .....76

Figure 5-19, Select Material screen.....77

Figure 5-20, Define Material screen .....78

Figure 5-21, Select Process screen .....85

Figure 5-22, Define Process screen.....86

Figure 5-23, Select Layer Material screen.....87

Figure 6-1, Splash Screen .....88

Figure 6-2, 861 Configuration Screen .....88

Figure 6-3, Operating Display .....89

Figure 6-4, Manual Power Handheld.....93

Figure 6-5, Run Selection Screen .....94

Figure 6-6, Rate vs. Time Graph.....95

Figure 6-7, Rate Deviation vs. Time graph.....95

Figure 6-8, Thickness vs. Time Graph .....95

Figure 6-9, Power vs. Time Graph .....96

Figure 6-10, Source/Sensor Status screen.....96

Figure 6-11, I/O Status Screen.....96

Figure 6-12, Typical Process Profile.....98

Figure 9-1, RS-232 Debug Computer Interface Screen.....112

Figure 10-1, RS-232 Debug Computer Interface Screen.....133

Figure 11-1, RS-232 Debug Computer Interface Screen.....151

Figure 12-1, RS-232 Debug Computer Interface Screen.....161

Figure 16-1, WEEE Symbol .....186

# 1 INTRODUCTION

---

Please read this manual carefully to ensure optimum operating conditions right from the start. This user manual handbook contains important information about the functionality, installation, start-up and operation of the Model 861.

## 1.1 INTENDED USE

---

The Telemark Deposition Controller is intended for use with electron beam (EB) sources or other thin film deposition equipment.

The 861 provides automatic control of single or multi-layer film depositions in either a production or development environment. It also improves predictability and repeatability of deposited film characteristics through dependable digital control of the deposition process. It runs unattended in the fully automatic mode and provides such features as run completion in the event of crystal failure, and extensive internal checking. Performance limits and the abort feature can be set by the user.

The device is referred to as Model 861 in the remainder of this manual.

## 1.2 LIABILITIES AND WARRANTY

---

Telemark is not liable for damages resulting from improper use of the device and the guarantee expires, if the user, or third party:

- ignores information contained in this manual,
- utilizes the product in a manner inconsistent with intended purpose,
- makes any modification or alteration of the product,
- unit should not be used with unauthorized accessories (compatible accessories, types and models can be found in the product documentation)

Telemark reserves the right to make changes without prior notice. Illustrations may vary depending on the version of the device.

## 1.3 SAFETY

---

### 1.3.1 Personnel Qualifications

All work described in this document may only be carried out by persons who have suitable technical training and the necessary experience or who have been instructed by the end user of the product.

### 1.3.2 Illustration of Residual Dangers

This Operating Manual illustrates safety notes concerning residual dangers as follows:



Information on preventing any kind of physical injury.



Information on preventing extensive equipment and environmental damage.





Information on correct handling or use. Disregarding safety notes can lead to malfunctions or equipment damage.

**Note:** Indicates particularly important, but not safety-relevant information.

## 1.4 GENERAL SAFETY INSTRUCTIONS

For all work you are going to do, adhere to the applicable safety regulations. Also observe all safety notes given in this document and forward the information to all other users of the product. Pay attention to the following safety notes:



Mains voltage.

Contact with live parts is extremely hazardous when any objects are introduced, or any liquids penetrate the device.

Make sure that no objects enter the device. Keep the device dry.

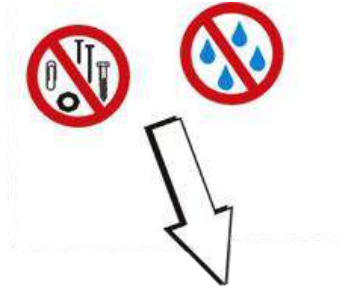



Figure 1-1, Keep Foreign Material Output of 861



Improper use.

Improper use can damage the 861.

Use the 861 only as intended by the manufacturer.



Improper installation and operation data.

Improper installation and operation data may damage the 861.

Strictly adhere to the stipulated installation and operation data.

## 1.5 SOFTWARE

---

Parts of the 861 software are made with open source software.

Linux is licensed under GNU General Public License (GPL), version 2.

All Xenomai code running in kernel space is licensed under the terms of the Linux kernel license, GNU General Public License (GPL), version 2.

Xenomai libraries linked to application are licensed under the terms of the GNU Lesser General Public License (LGPL), version 2.1.

Qt is licensed under GNU Lesser General Public License (LGPL) version 2.1.

The original “open source” source code is available from Telemark for a nominal fee.



## 2 TECHNICAL DATA

---

### 2.1 GENERAL DATA

---

#### 2.1.1 Mechanical Data

Dimensions:	19-inch (483mm) rack 2U, 3 1/2" (89mm) high x 9.41" (239mm) deep, See Fig. 2-1
Net Weight:	5.8 lb. (2.6 kg)

Controller Installation: 19" Rack standard or Bench Top unit

Assembly: Connected outside of a high vacuum system to electron beam source or other deposition source that is inside a high vacuum system.

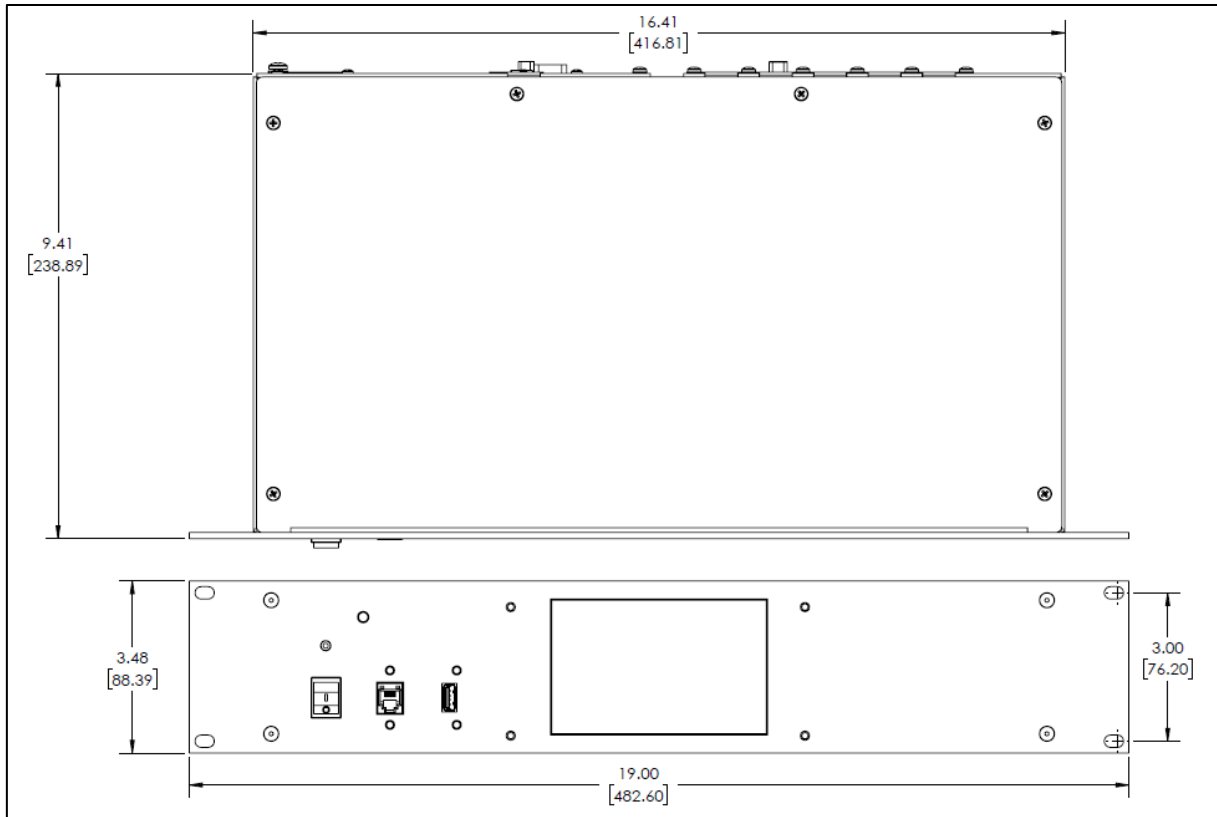

**Figure 2-1, 861 Reference Dimensions**

**2.1.2 Ambience**

- Temperature Storage: -20...+60 °C
- Operation Temperature: +5...+40 °C
- Relative Humidity: Max. 80 % (up to 31 °C), decreasing to max. 50 % (above 40 °C)

Use indoor only

- Altitude: max. 2000 m n.p.m.
- The degree of dust standard: II
- Humidity resistance: IP20

**2.1.3 Use and Operating Modes**

There are two common operation modes:

1. Manual control, with the touchscreen on the front panel
2. Hardware remote control with I/O interface, ethernet

This mode is active by pressing the Remote button on the touchscreen. In this mode the only button available on the touchscreen is to return to manual mode.

### 2.1.4 Standards

Conformity with the Directive relating to electrical equipment designed for use within certain voltage limits 73/23/EWG

Conformity with the Directive relating to electromagnetic compatibility 89/336/EWG

Harmonized and international/national standards and specifications:

EN 61010-1 (Safety requirements for electrical equipment for measurement, control and laboratory use)

EN 61000-6-2 (Electromagnetic compatibility generic immunity standard)

EN 61000-6-3 (Electromagnetic compatibility generic emission standard)

## 2.2 MAINS CONNECTION



---

Voltage:	90 to 264 VAC, 1 phase operation
Frequency:	47 - 63 Hz
Current consumption:	Max. 0.2 A at 120V, Max. 0.2 A at 230V
Power consumption:	Max. 10 W
Overvoltage category II	
Protection class 1	
Connection US	
appliance connector	IEC 320 C14
Fuse	Slow Blow, 2 A, 250 V, 5mm x 20mm

## 2.3 PACK LIST

### 2.3.1 Standard Items

The standard items included with the 861 controller are:

Part No.	Quantity	Description	
861-0500-3	1	Oscillator Assembly	
861-0510-3	1	Assembly, Remote	
861-0600-3	1	Assembly, Chassis 861	
861-5000-1	1	Shipping Kit, 861	

#### 861-5000-1, Shipping Kit, 861



Part No.	Quantity	Description	
122-0505-1	1	Cable, Null Modem, 9 Pin, F/F	
122-0861-1	1	Cable, Oscillator, 25 FT.	
124-0909-8	1	Connector Kit, 9 Pin, D-Sub Male	

124-0937-9	1	Connector Kit, D-Sub, 37pin, Female	
200-0004-1	1	Telemark 851/861 USB Drive	
376-9010-1	1	Power Cord	
861-0301-1*	1	Cable, Source Adaptor, DB9 to 4 pin F DIN	
861-0502-1**	1	Adapter, BNC Male/Male	
880-2421-1	1	Cable, 6" BNC M-M	

\* 6 inch DB9 to 4-pin mini DIN connector adaptor is available to connect an 861 to an existing 860 installation without rewiring the source signal. In new installations it is not used.

\*\* A BNC male/male adaptor is supplied for installations that have a 6-inch female BNC cable coming from the vacuum system feedthrough

If ordered at the same time as the 861 input/output cards will be installed in the unit. Below is a list of possible I/O cards that can be installed.

Part No.	Description	
120-0564-1	PCB, I/O, DB37	
120-0571-1	PCB, Input, DB25	
120-0572-1	PCB, Output, DB25	



If ordered at the same time as the 861 a second Source/Sensor card for sensors 3 and 4 will be installed.

Part No.	Description	
120-0562-1	PCB, Source Control/Sensor	



### 2.3.2 Optional Items

Optional items that may be ordered and shipped with an 861.

1. Additional Oscillator and shielded RJ45 cable for sensors 2, 3, and 4.  
861-0505-1, Oscillator Kit

Part No.	Qty	Description	
122-0861-1	1	Cable, Oscillator, 25 FT.	
861-0500-3	1	Oscillator Assembly	
861-0502-1	1	Adapter, BNC Male/Male	

2. Each sensor needs a 6 inch coax cable to go between the oscillator and the feedthrough. The type needed depends on the feedthrough connection.



Part No.	Description	
880-2420-8	Cable, 6" BNC Male/Microdot	
880-2421-1	Cable, 6" BNC Male/Male	

- Each sensor needs a 30 inch coax in-vacuum cable to go between the feedthrough and the sensor inside the vacuum chamber.

Part No.	Description	
880-2320-4	30 inch coax in-vacuum cable, Microdot	

- Telemark has a wide selection of O-Ring and CF flange feedthroughs available to pass the cooling water and coaxial signal in to the chamber.

5. Crystals

Part No.	Description	
880-0201-3	6MHz gold coated sensing crystals (Disc of 10)	
880-0202-3	6MHz aluminum alloy sensing crystals (Disc of 10)	
880-0203-3	5MHz gold coated sensing crystals (Disc of 10)	

Please refer to the Telemark Price List for feedthroughs, more accessories and other products.



## 2.4 SPECIFICATIONS

Electrical	
Input Supply Voltage	90 to 264 Vac (47 .... 63 Hz), 1 phase operation *
Input Current	Max 0.2A
Mode of operation	Deposition Controller
Methods of control	Local or remote through Communication Interface
Dimensions	Controller dimensions: 19-inch (483mm) rack 2U, 3 1/2" (89mm) high x 9.41" (239mm) deep
Weight	Net Weight: 5.8 lb. (2.6 kg)

### 2.4.1 Measurement

Frequency Resolution	0.03 Hz @6.0 MHz
Mass Resolution	0.375 ng/cm <sup>2</sup>
Thickness Accuracy	0.5% + 1 count
Measurement Update Rate	Dynamically adjusted, 0.5 to 10 Hz
Display Update Rate	1 Hz
Sensor Crystal Frequency	5 or 6 MHz

### 2.4.2 Display

Thickness Display	Autoranging: 0.000 to 999.9 KÅ
Rate Display	Autoranging: 0.0 to 999 Å/sec
Power Display	0.0 to 99.9%
Time To Go	0 to 9:59:59 H:MM:SS
Crystal Health %	0 to 99%
Layer Number	1 to 999
Graphics Display	480x800 Color LCD touch screen with backlighting

### 2.4.3 Communication

	RS-232
	Ethernet (TCP/IP)

### 2.4.4 Program Storage Capacity

Process	99, user definable
Layer	999, user definable
Material	99, user definable

### 2.4.5 Process Parameters

Process Name	12 character string
Layer# 1 to 999	Material name, Thickness, Pocket Override

**2.4.6 Material Parameters**

Material Name	12 character string
Thickness (Only used when run as a Film)	0 to 999.9 KÅ
Sensor #	1 to 4
Crystal #	1 to 8
Source #	1 to 4
Pocket #	1 to 30
Material Density	0.80 to 99.9 gm/cm3
Acoustic Impedance	0.08 to 90.00 gm/cm2 sec
Tooling Factor	10.0 to 499.9%
Proportional gain	0.00 to 9999
Integral Time constant	0 to 99.9 sec
Derivative Time constant	0 to 99.9 sec
Rise to Soak Time	0 to 9:59:59 H:MM:SS
Soak Power	0 to 99%
Soak Time	0 to 9:59:59
Soak Sweep Pattern	0 to 63
Rise to Predeposit Time	0 to 9:59:59
Predeposit Power	0 to 99.9%
Predeposit Time	0 to 9:59:59
Predeposit 861 Pattern	0 to 63
Rate Establish Time	0, 6 to 5999 sec
Rate Establish Error	0 to 99.9%
Deposition Rate (1 to 5)	00.0 to 999.9 Å/sec
Rate Ramp	Disabled, Thickness (KÅ), Thickness (%)
Rate Ramp Start (1 to 4)	0.000 to 999.9 KÅ or 0 to 100%
Rate Ramp Stop (1 to 4)	0.000 to 999.9 KÅ or 0 to 100%
Deposition Sweep Pattern	0 to 63
Time Setpoint	0 to 9:59:59
Feed Enabled	Enabled, Disabled
Ramp to Feed Time (Feed Enabled)	0 to 9:59:59
Feed Power (Feed Enabled)	0 to 99.9%
Feed Time (Feed Enabled)	0 to 9:59:59
Feed Sweep Pattern (Feed Enabled)	0 to 63
Ramp to Idle Time	0 to 9:59:59
Idle Power	0 to 99.9%
Maximum Power	0 to 99.9%
Power Alarm Delay	0 to 99 sec
Minimum Power	0 to 99.9%
Rate Deviation Attention	0 to 99.9%
Rate Deviation Alarm	0 to 99.9%
Rate Deviation Abort	0 to 99.9%
Sample Dwell %	0 to 100.0%
Sample Period	0 to 9:59:59
Crystal Marginal %	0 to 99%
Crystal Fail	Switch, Time Power, Halt, SwitchTimePower
Backup Sensor #	1 to 4

Backup Tooling Factor	0 to 499.9%
Backup Crystal #	1 to 8
Crystal Switch Settling	0 to 240

Note: Rate Ramp Start #2-#4, Rate Ramp Stop #2-#4, and Deposit Rate #3-#5 are hidden until needed.

The 861 also has a built in material library that contains many common material names along with their density and acoustic impedance values.

### 2.4.7 Input/Output Capability

There are four I/O slots in the model 861. Each slot can house one of the three following cards.

Discrete Input, 25 pin D connector PCB Part number 120-0571-1	8 fully programmable inputs The card is software configured one of two ways: <b>Passive</b> TTL level inputs activated by a short across input pins. <b>Active</b> inputs activated by 12 to 24 volts AC/DC across the input pins.
Discrete Outputs, 25 pin D connector PCB, Part number 120-0572-1	8 fully programmable outputs, SPST relay, 50VDC max, 2A max.
Discrete Input/Output, 37 pin D connector PCB Part number 120-0564-1	8 fully programmable inputs The card is configured with jumpers one of two ways: <b>Passive</b> TTL level inputs activated by a short across input pins. <b>Active</b> inputs activated by 12 to 24 volts AC/DC across the input pins. 8 fully programmable outputs, SPST relay, 50VDC max, 2A max. 1 dedicated "Abort" output, SPST relay, 50VDC max, 2A max.

### 2.4.8 Source/Sensor Capability

Sensor Inputs	RJ45 connector 2 Standard and 2 optional
Source Outputs	9 pin D connector 2 Standard and 2 optional fully isolated, 2.5, 5 or 10 volts @ 20 ma. 0.002% resolution

### 2.4.9 Oscillator Capability

Oscillator Input	BNC, In a standard installation it is connected to a 6 inch coaxial cable, but the total cable length from crystal head to oscillator must be between 24 to 48 inches. Please contact the factory for options when the length is outside of this range.
Oscillator Output	RJ45 connector connects to the 861 via supplied 25 foot RJ45 shielded cable. Other lengths are available.

### 2.4.10 Sensor Parameters

Number of Crystals	1 to 8
Shutter Relay Type	Normally open, normally closed, dual, or none.
Position Control	Manual, direct, Binary 1=00000, Binary 1=00001, or individual.
Position Drive	Up, down, single step
Feedback Type	Binary 1=00000, Binary 1=00001, in position, or no feedback.
Rotator Delay	0 to 99 sec

**2.4.11 Source Parameters**

Number of Pockets	1 to 30
Shutter Relay Type	Normally open, normally closed, or none.
Shutter Delay	0.0 to 9.9 sec
Pocket Control	Manual, direct, Binary 1=00000, Binary 1=00001, or individual.
Drive	Up, down
Feedback Type	Binary 1=00000, Binary 1=00001, in position, or no feedback.
Feedback Pause	0 to 10 sec
Rotator Delay	0 to 99 sec
Source Voltage	2.5, 5, 10 volts
Sweep Control	None, Binary 1=00000, Binary 1=00001, Individual
Number of Sweep Patterns*	0-63
Sweep Feedback Type*	No Feedback, Ready
Sweep Delay*	0 to 99 sec

\*Only shown when Sweep Control enabled

**2.4.12 DAC**

Rate Output	Disabled, 2-Digit, 3-Digit
Thickness Output	Disabled, 2-Digit, 3-Digit, Target Thickness

**2.4.13 Utility Parameters**

Crystal Frequency	5 or 6 MHz
Simulate Mode	On/Off
Serial Protocol	Standard, ASCII no checksum, ASCII checksum, 360C, Mixed ASCII
Interface Address	1 to 32
Ethernet Configuration	Static, DHCP
IP Address (Static only)	xxx.xxx.xxx.xxx
Subnet Mask (Static only)	xxx.xxx.xxx.xxx (Default 255.255.255.0)
Attention Volume	0 to 10
Alert Volume	0 to 10
Alarm Volume	0 to 10
Touch Volume	0 to 10
Error Beep Volume	0 to 10
Pause on Layer Complete	On/Off
Data Points/Minute	30 to 600 PPM
Confirm Saves	Enabled, Disabled
Input Hold Time	0 to 5 sec.
RS232 Use CTS	On, Off
RS232 Baud	9600, 19200, 38400, 57600, 115200
Ave Target Thickness	Enabled, Disabled
Date	MM/DD/YY
Time	0 to 23:59

### 2.4.14 Display Parameters

VNC Display	On/Off
Brightness	Low, Medium, High
Screen Saver	Off, 5 min, 15min, 1hr, 4 hr
Time To Go Display	Estimated State, Estimated Layer, Elapsed Process, Elapsed Layer, Elapsed State
Display Negatives	On/Off
Thickness Vs. Time Graph	Enabled, Disabled
Rate Vs. Time Graph	Enabled, Disabled
Rate Dev. Vs. Time Graph	Enabled, Disabled
Power Vs. Time Graph	Enabled, Disabled
Source/Sensor Status	Enabled, Disabled
I/O Status	Enabled, Disabled
Display Average (sec)	1-6
Locale	English, Chinese
Show Clock Errors	Enabled, Disabled

## 2.5 FEATURES

---

The 861 controls the rate and thickness of thin film deposition by controlling the power supply emission current of a e-beam source power supply by monitoring a quartz crystal.

A simple front panel touch screen color LCD (liquid crystal display) and handheld is used to configure and run processes. The LCD display allows for easy visualization of operation. The LCD panel prompts the user through the various steps of a normal operation.

## 2.6 INTERFACES

---

### 2.6.1 Input Interface

Connector: D-Sub 25 male connector or 37 pin

Refer to chapter 3 for details

No of Digital Inputs: 8 to 32 – Inputs are contact closure to reference.

Response time: 50 ms max

No of Digital Outputs: 8 to 32 – Relay; 50V maximum compliant

Response time: 50 ms max

## 3 INSTALLATION

---

### 3.1 UNPACKING

---

1. Visually inspect the transport packaging for signs of external damage
2. Unpack the 861 and put the packaging material aside

**Note:** Keep the packaging material for later use. The 861 must be stored and transported in the original packaging material only.

3. Examine the 861 for completeness
4. Visually inspect the 861 for signs of damage



Damaged product.

Putting a damaged product into operation can be extremely dangerous.

Never attempt to put a damaged product into operation. Secure the damaged product from unintended operation. Send a damage report to the haulage company or the insurer.

### 3.2 MECHANICAL INSTALLATION

---

The 861 is intended for rack mounting. For maximum operating ease it should be mounted at approximately eye level. If the 861 is mounted in a rack containing other heat generating equipment, care should be taken that there is adequate ventilation to

assure that the ambient temperature does not exceed the 861's ambient temperature rating.

861 can be used in the following ways: as a bench top device, mounted in a control panel or mounted in a 19 "rack. In each case, consider the following important safety information:



The temperature of the environment. Exceeding the allowable temperature of the device may damage the unit.

Make sure that the maximum permissible ambient temperature is not exceeded, and the air can circulate freely through the ventilation slots. Do not expose the device to direct sunlight.

### 3.2.1 Required components

The following is the minimum list of components required for setting up the 861 for safe operation.

- Electron beam source or other evaporation source and power supply in working order.
- Vacuum system.
- 19-inch rack with 90-264VAC, 47-63 Hz power to house the controller.
- Cable from ground on chamber to ground stud on 861 controller.

## 3.3 INSTALLATION

---

The Electron Beam source (EB source) 861 is designed to be mounted in a standard 19-inch electronic instrument cabinet. Other suitable places on a vacuum system may be used. The installation procedures are described below.

### 3.3.1 Rack Installation

The 861 is designed for installation into a rack according to DIN 41 494 (19", 2 HU).



Ambient temperature.

Exceeding the maximum permitted ambient temperature may damage the device.

Make sure that the maximum permitted ambient temperature is not exceeded. Do not expose the device to direct sunlight.



Protection class of the rack.

If the product is installed in a rack, it is likely to lower the protection class of the rack (protection from foreign bodies and water) e.g. according to the EN 60204-1 regulations for switching cabinets.

Take appropriate measures to restore the required protection class of the rack.

## 3.4 CONTROLLER CONNECTING



Figure 3-1, Front Panel Connection

### 3.4.1 Front Panel

A – **Manual Power Handheld**, The Remote Power Handset is plugged into the front panel and is used to control a power supply power setting and has an abort button.

The Handheld can be used when needed and removed when not needed.

B – **USB**, Type A, the USB is used to connect a USB drive to backup and restore settings and to update 861 software.





Figure 3-2, 861 Manual Power Handheld

### 3.4.2 Rear Panel

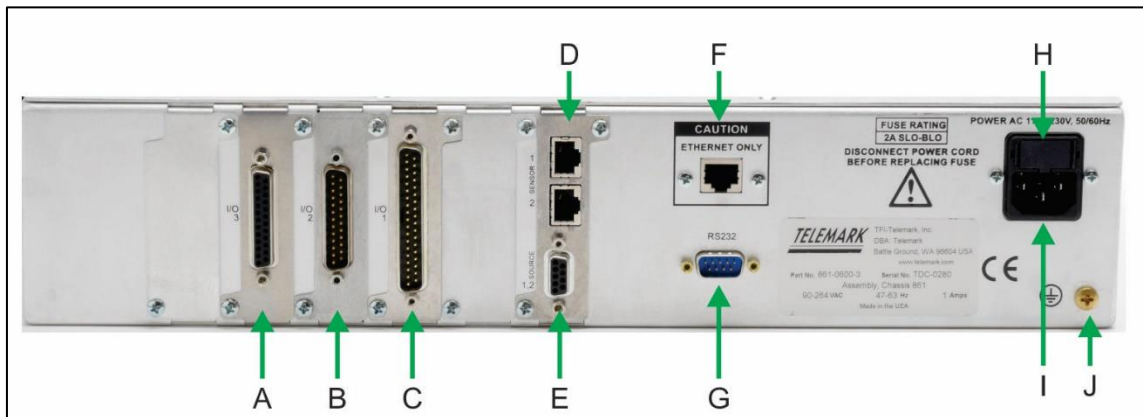

Figure 3-3, Rear panel 861 Controller

- A – **25 pin input card** (see chapter 3.4.7 for details)
- B – **25 pin output card** (see chapter 3.4.7 for details)
- C – **37 pin input/output card** (see chapter 3.4.7 for details)
- D – **Sensor Input** (see chapter 3.4.7 for details)
- E – **Source Output** (see chapter 3.4.7 for details)
- F – **Ethernet port** (see chapter 3.4.3 for details)
- G – **RS232 port** (see chapter 3.4.3 for details)
- H – **Fuses** (see chapter 3.4.3 for details)
- I – **Main power socket IEC C13** (see chapter 3.4.3 for details)
- J – **Grounding screw** (see chapter 3.4.4 for details)

Note: I/O slots 1-4 can have any combination of I/O cards, 25 pin input, 25 pin output, or 37 pin input/output.

The configuration of the available connections and photographs of cables is described in the following sections.

### 3.4.3 Mains Connection

The mains connection is designed for a mains cable which contains IEC 320 connector on the device side. A mains cable is supplied with the device. If the plug is not compatible with your wall socket, you should replace it with a suitable mains cable:

Three-conductor cable with protective ground

Conductor cross-section  $3 \times 1.5 \text{ mm}^2$  or larger

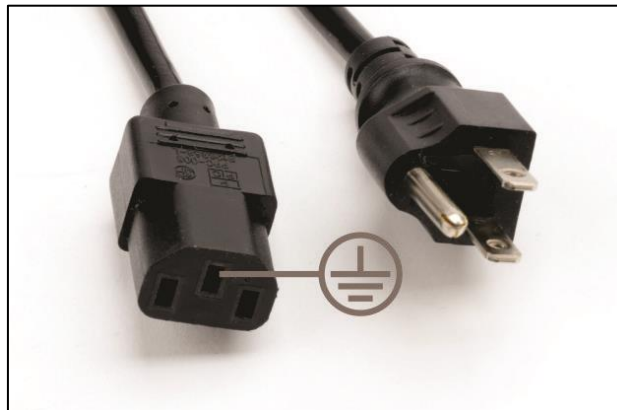

Figure 3-4, Three-conductor cable with protective ground (example)



Mains power.

Improperly grounded devices can be extremely dangerous in the event of a fault. Use three-wire mains or extension cables with protective ground only. Plug the mains cable into wall sockets with protective ground only.

1. Connect the appliance connector of the mains cord with the mains connection of the device
2. Connect the plug of the mains cable with the wall socket

Note:

If the device is installed in a switching cabinet, the mains power can be supplied via a switchable central power distributor.

### 3.4.4 Grounding

Grounding screw (Fig. 3-3, the reference J) should be used to connect the 861 with the main grounding system in which it operates. It is recommended to use a cable with a minimum section of 2.5 mm<sup>2</sup>

If required, connect the vacuum system ground from the earthing screw using the protective conductor.

### 3.4.5 RS-232

The RS-232 connector is for connecting the 861 to a PLC or computer for remote operation and/or data collection, see chapter 8. **CTS and RTS are optional.**

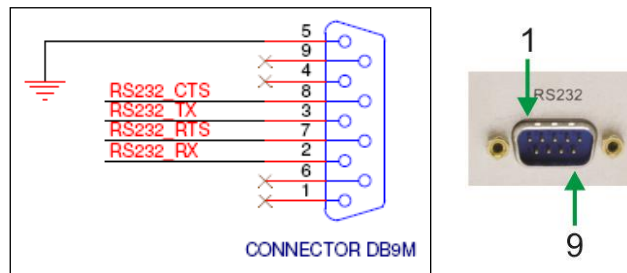

Figure 3-5, RS-232 Connection

### 3.4.6 Ethernet

The Ethernet connector is for connecting the 861 to a computer to run the touch screen remotely using VNC, see chapter 4.

The Ethernet interface allows to communication based on IEEE 802.2 standard with 100 MB/s speed.

Note: to achieve best performance and speed, the LAN cable has to be shielded and Cat-6 or higher. For a direct connection to a computer use a crossover cable. For connection to a network hub or switch use a non-crossover cable.

**DO NOT PLUG THE CABLE FROM THE OSCILLATOR INTO THE ETHERNET CONNECTOR.**

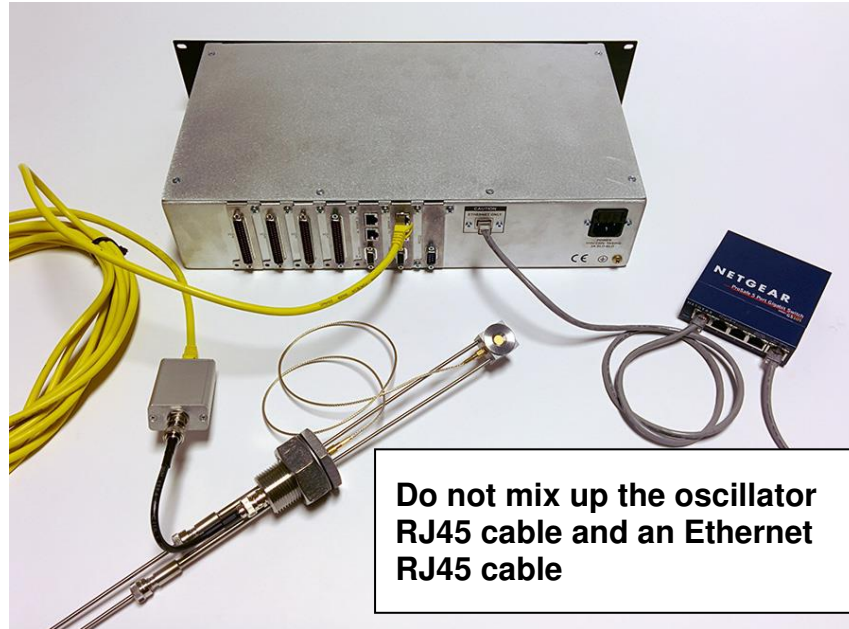

Figure 3-6, Ethernet Connection

### 3.4.7 Source-Sensor

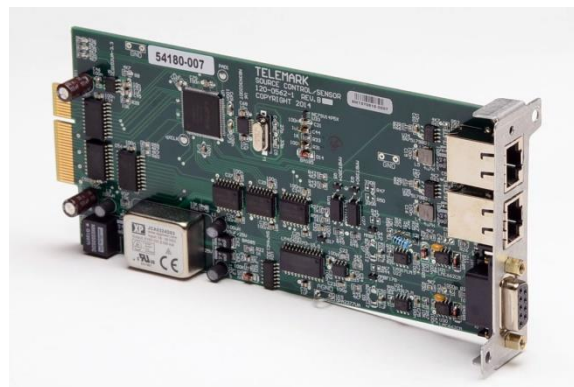
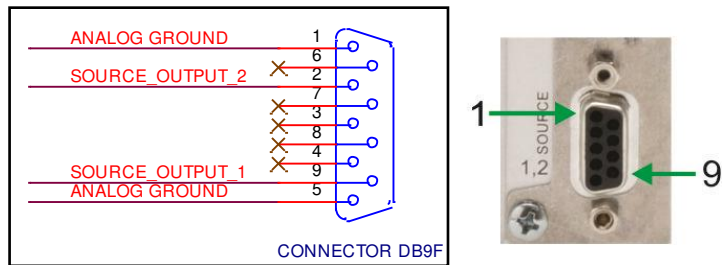

Figure 3-7, Source-Sensor Card

The system interface with the sensor oscillator is a **Shielded** RJ45 cable that is supplied with the 861.

**ONLY PLUG THE CABLE FROM THE OSILLATOR INTO RJ45 CONNECTOR ON THE SOURCE-SENSOR CARD.**

The control voltage output to control a HV power supply is via a 9-pin female D connector. See figure 3-8.



**Figure 3-8, Source Connection**

Pin Number	Signal	
	Source-Sensor Bd #1	Source-Sensor Bd #2
1	Source #2 Return	Source #4 Return
2	Source #2 Control Voltage	Source #4 Control Voltage
5	Source #1 Return	Source #3 Return
9	Source #1 Control Voltage	Source #3 Control Voltage

**Optional** 6-inch DB9 to 4-pin mini DIN connector adaptor is available to connect an 861 to an existing 860 installation (part number 861-0301-1). See figure 3-9.

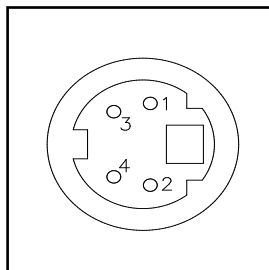

**Figure 3-9, 860 Source Adaptor Pin Out**

Pin Number	Signal	
	Source-Sensor Bd #1	Source-Sensor Bd #2
1	Source #2 Control Voltage	Source #4 Control Voltage
2	Source #2 Return	Source #4 Return
3	Source #1 Return	Source #3 Return
4	Source #1 Control Voltage	Source #3 Control Voltage

### 3.4.8 Discrete Input, 25 Pin



**Figure 3-10, 25 Pin Input Card**

The input card (part number 120-0571-1) with a 25-pin female D connector has 8 fully programmable inputs.

The card is **software configured** (see chapter 4) one of two ways:

1. **Passive** TTL level inputs activated by a short across input pins.
2. **Active** inputs activated by 12 to 24 volts AC/DC across the input pins.

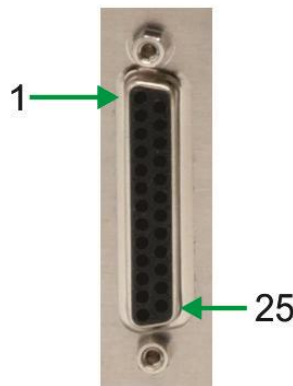
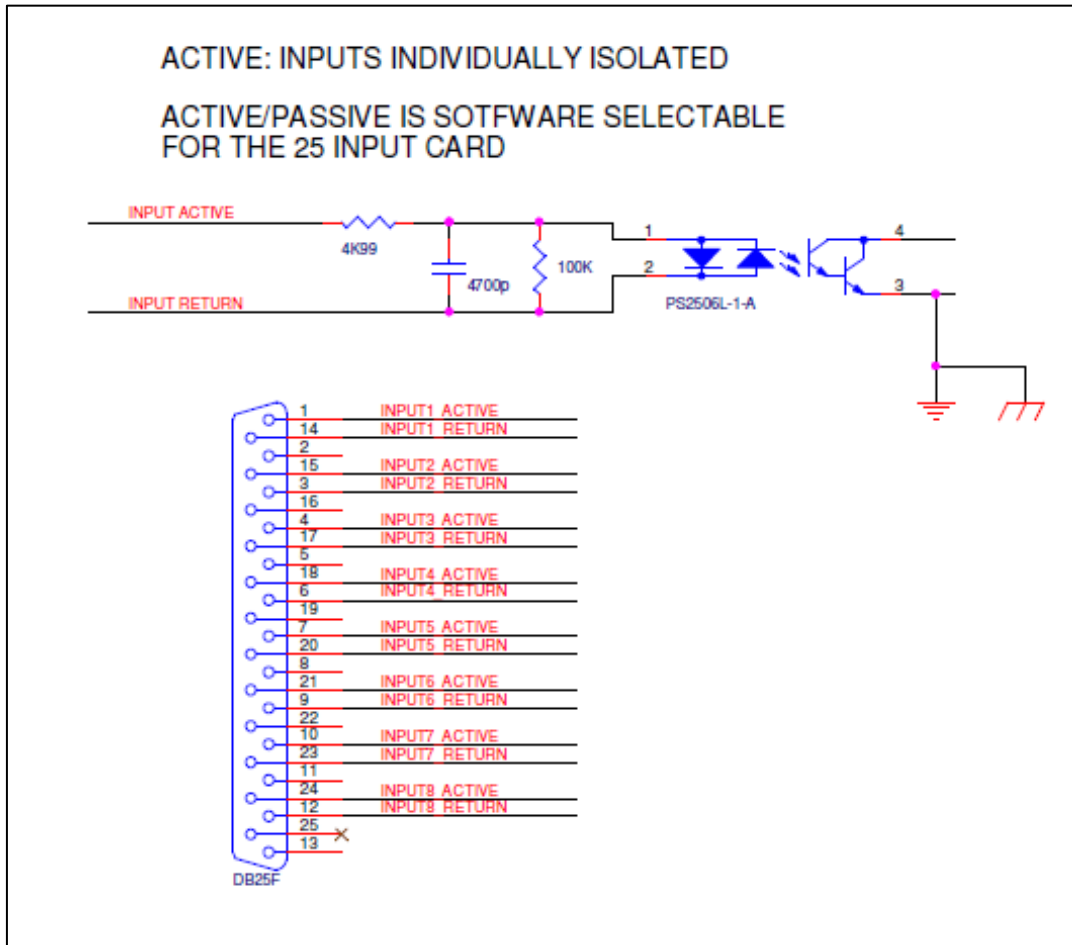

Figure 3-11, Active 25-Pin Input Card Connections

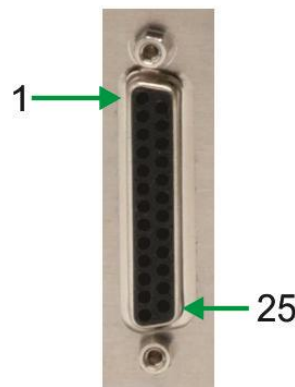
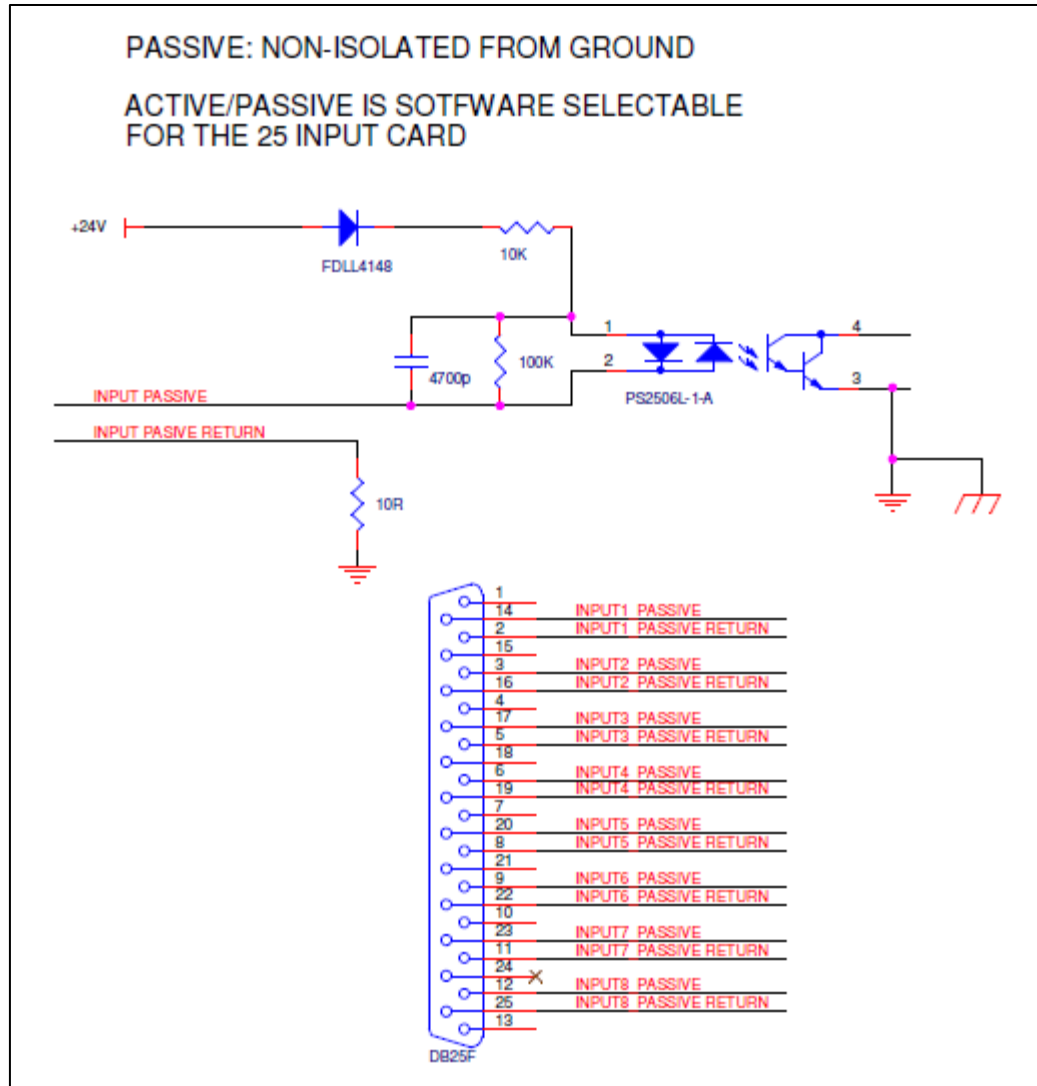
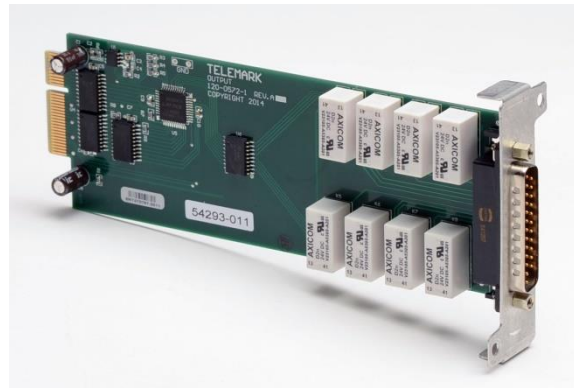

Figure 3-12, Passive 25-Pin Input Card Connections

### 3.4.9 Discrete Output, 25 Pin



**Figure 3-13, 25-Pin Output Card**

The output card (part number 120-0572-1) with a 25-pin male D connector has 8 fully programmable outputs that are made through SPST relays that are 50VDC max and 2A max. For each output connections can be made to the normally open (N.O.) and/or the normally closed (N.C.).

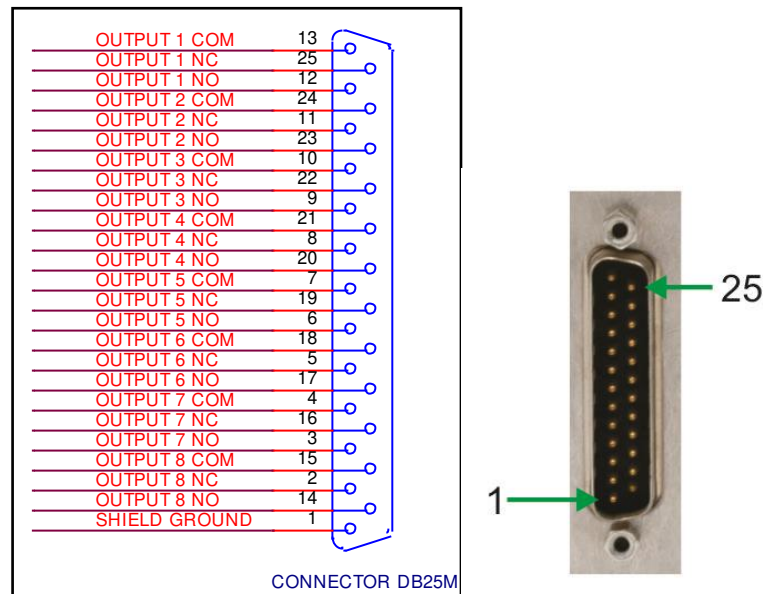

**Figure 3-14, 25 Pin Output Card Connections**



### 3.4.10 Input/Output, 37 Pin

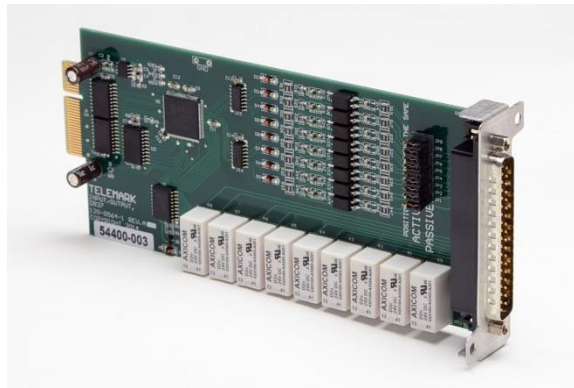

Figure 3-15, 37-Pin Input/Output Card

The input/output card (part number 120-0564-1) with a 37-pin male D connector has 8 fully programmable inputs and 8 fully programmable outputs plus one dedicated “Abort” output.

The input type is **configured by jumpers on the PCB** (see figure 3-16) one of two ways:

1. **Passive** TTL level inputs activated by a short across input pins.
2. **Active** inputs activated by 12 to 24 volts AC/DC across the input pins.

The outputs are made through SPST relays that are 50VDC max and 2A max. Each output connection is made to the normally open (N.O.) and additionally for output 1 and 2 the normally closed (N.C.) may be used.



Figure 3-16, 37-Pin I/O Card, Active/Passive Jumpers

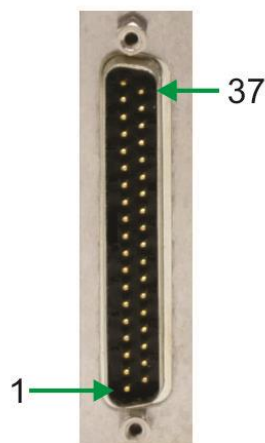
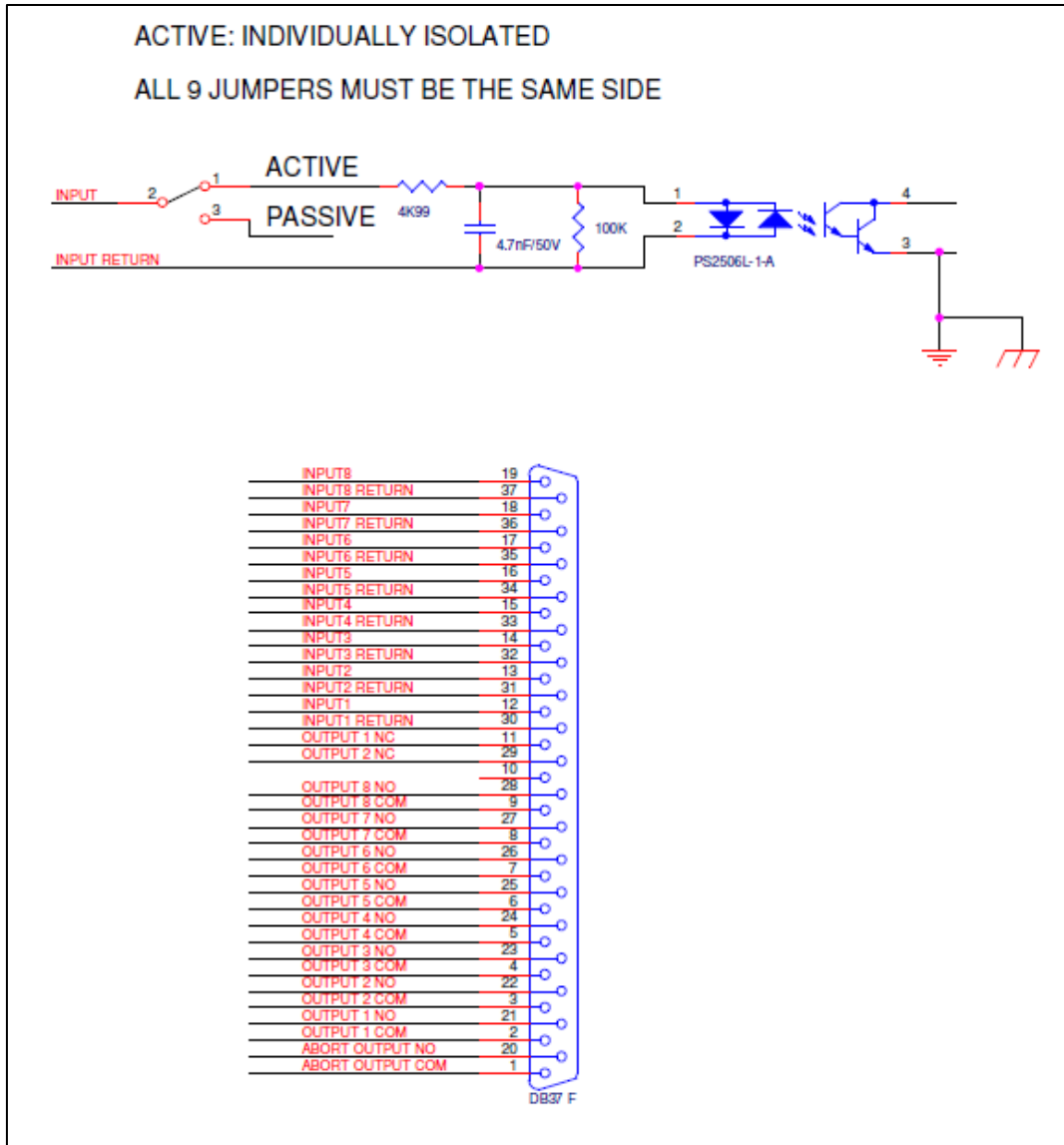

Figure 3-17, Active 37-Pin I/O Card Connections

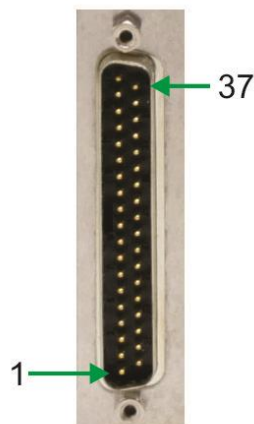
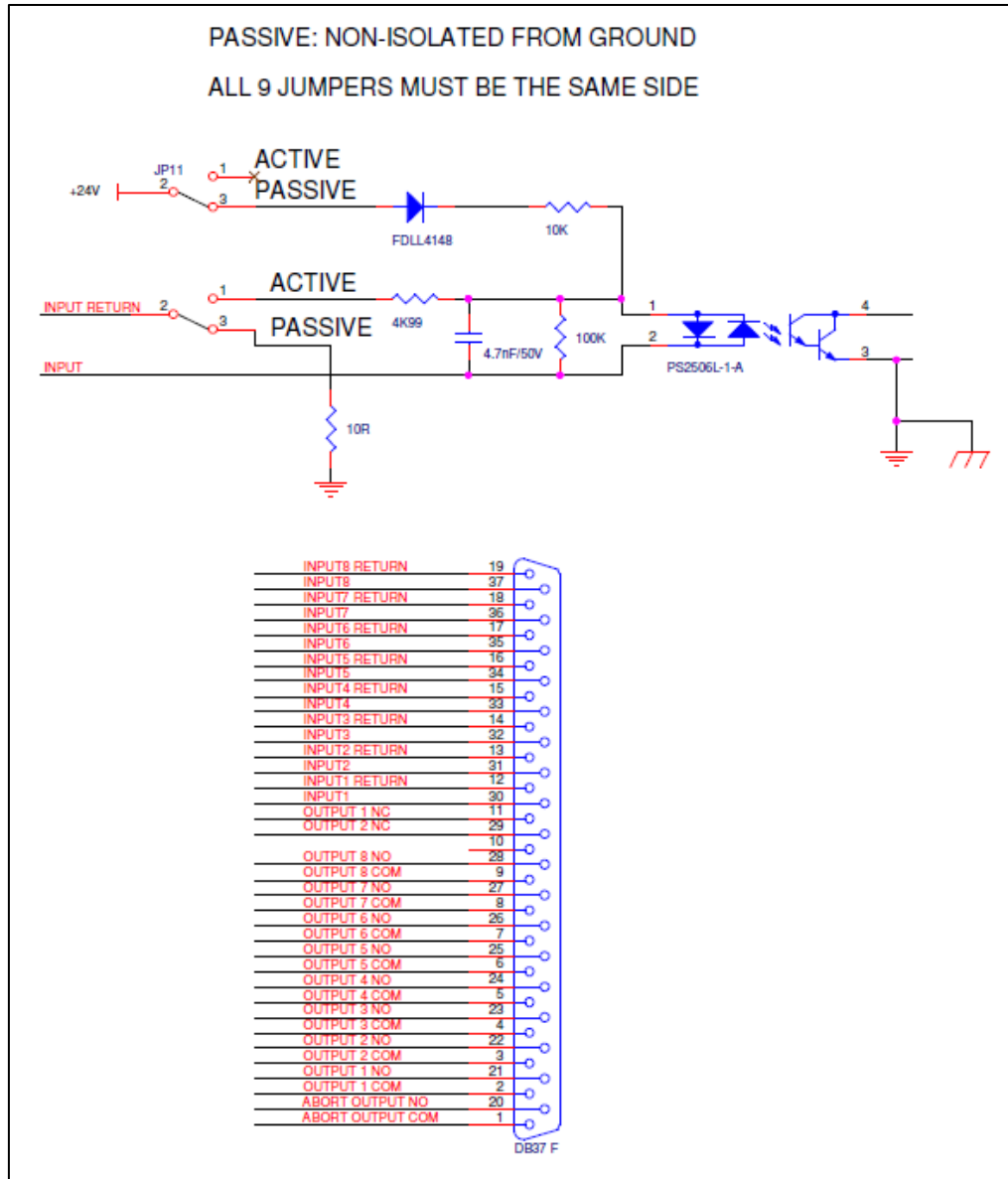

Figure 3-18, Passive 37-Pin I/O Card Connections

## 3.5 INSTALLING ADDITIONAL BOARDS

---

Option boards are most easily installed while the 861 is on the bench. Figure 3-3 shows the location of the various option boards. Also, they are clearly marked on the rear panel.

All 861 ship from the factory with at least one source sensor board and at least one I/O board.

All Dual Source-Sensor boards are identical. A Source-Sensor board plugged into the second position will provide sensor inputs numbers 3 & 4, and source outputs numbers 3 & 4.

Discrete I/O boards come in three types:

- Discrete Input, 25-pin D connector
- Discrete Outputs, 25-pin D connector
- Input/Output, 37-pin D connector PCB

The input-output configuration of these boards is defined by the position into which they are installed.

### 3.5.1 Source-Sensor Board

1. Unplug power.
2. Remove the chassis top cover.
3. Remove blank plate from the empty Source/Sensor slot on the rear panel.
4. Carefully slide in the new card and insert in the edge connector.
5. Tighten the two mounting screws.
6. Replace the chassis top cover and apply power to the controller.
7. The Sign On screen should acknowledge Source-Sensor card 2 is installed.

### 3.5.2 Discrete I/O Board

1. Unplug power.
2. Remove the chassis top cover.
3. Remove blank plate from an empty I/O slot on the rear panel.
4. Carefully slide in the new card and insert in the edge connector.
5. Tighten the two mounting screws.
6. Replace the chassis top cover and apply power to the controller.
7. The Sign On screen should acknowledge that Discrete I/O 2, 3 or 4 installed.

## 3.6 SENSOR HEAD INSTALLATION

---

The sensor head can be installed in any appropriate location in the vacuum chamber, preferably more than 10 inches from the evaporation source. The internal (vacuum) cable, supplied with a sensor kit, connects the sensor head to the electrical feedthrough, to which the oscillator is attached. The cable length from sensor head to feedthrough connection should be 30 inches. Shield the sensor cable in the most

expedient way possible to protect it from radiation heat released from the evaporation source or the substrate heater.

The water-cooling tube connects to the feedthrough by brazing or vacuum couplings. If necessary, both cable and water lines may be wrapped in aluminum foil to extend their useful life. Water cooling of the sensor head should always be provided during depositions.

Use a shutter to shield the sensor during initial soak periods to protect the crystal from any sputtering that may occur. If a small droplet of molten material hits the crystal, the crystal may be damaged, and oscillation may cease.

### 3.7 SENSOR OSCILLATOR

---



**Figure 3-19, Oscillator and Cables**

The sensor oscillator is designed to be used with industry standard 5 or 6 megahertz sensor crystals. The oscillator's characteristics enable it to obtain maximum life from the sensor crystal.

The oscillator is supplied with a 6-inch coaxial cable and a RJ45 shielded twisted pair 25-foot cable. The 6-inch cable interconnects the oscillator and the feedthrough. The 25-foot cable interconnects the oscillator and the 861. Cables of varying lengths are available upon request for replacing the 25-foot cable.

The standard 6-inch coaxial cable is fine for most installations, but the total cable length from crystal head to oscillator must be between 24 to 48 inches. Many UHV and multi crystal head installations will require a custom coaxial cable. Please contact the factory for custom cables. For installations where the crystal head to oscillator must be greater than 48 inches, the 861-0500-4 oscillator should be used.

#### **CAUTION**

**Always use the cables supplied by Telemark to make the connections. Failure to make this connection correctly will create a mismatch in the impedance of the oscillator circuit.**

### 3.8 OSCILLATOR TEST

---

To troubleshoot problems with the 861 sensing the crystal a button on the oscillator will produce a reference frequency of 5.5MHz.

The recessed button on the Crystal connector side of the oscillator can be depressed to produce the reference frequency of 5.5MHz. This will produce a frequency of 5.5MHz which can be observed on the 861 touchscreen display. By pressing the “i” on the righthand side of the screen the screen will cycle between the graphs, the I/O status and the Crystal Sensor status. Cycle thought to the Crystal Sensor screen. It should show a frequency of somewhere around 5.5MHz. If it does show a value near 5.5MHz then the oscillator and the 861 are working properly. If it shows “—” or much larger number than 5,500,000 then there must be something wrong with the cables or feedthrough between the oscillator and r sensor head or the crystal.

Note: This will only work with the 861 in 6Mhz mode. If you are using 5MHz crystals, go to Program – Setup – Utility – Crystal Frequency and temporarily change it to 6Mhz to use the reference frequency and then change back after you are done.



Figure 3-20, Oscillator Test button



Figure 3-21, Frequency on Sensor Status screen

### 3.9 INSTRUMENTATION FEEDTHROUGH

---

Telemark has a wide selection of O-Ring and CF flange feedthroughs available to pass the cooling water and coaxial signal into the chamber.

### 3.10 SENSOR CRYSTAL REPLACEMENT

---

The Telemark Sensor Head is especially designed for easy sensor crystal replacement and reliable operation. Removal and replacement of sensor crystals should be performed in a clean environment. An isolated clean work bench is

recommended for crystal replacement. To prevent crystal contamination, use clean lab gloves or plastic tweezers when handling the crystal and keep the new crystals in a closed plastic case.

### 3.11 REMOTE CONTROL

---



Improper connection.

In the case of incorrect connection - in accordance with Figure 3-5, 3-8, 3-9, 3-11, 3-12, 3-14, 3-17 and 3-18 there is a danger of damage to the controller

## 4 USING THE 861

### 4.1 FRONT PANEL

Please refer to Fig. 4-1 for front panel details



Figure 4-1, Front Panel

A – **POWER SWITCH** (see chapter 4.1.1 for details)

B - **Power On LED** indicator (see chapter 4.1.2 for details)

C - **HANDHELD** (see chapter 4.1.3 for details)

D - **USB** (see chapter 4.1.4 for details)

E - **LCD touch screen** (see chapter 4.1.5 for details)

#### 4.1.1 Main Power Switch

Switching On the power button (position 'I') activates the main power circuit of the device. Switching off the unit (position 'O' switch) completely cuts the power to the internal circuits - controller is safe to make rear panel connections.





Risk of the electric shock!

All connection to the devices may only be carried out with the unit is turned off - the main power switch in 'O' position.

Failure to do so may cause electric shock

### 4.1.2 Power On LED indicator

Green LED indicates the unit power is on.

### 4.1.3 Handheld

The handheld can be plugged in or unplug at any time.

### 4.1.4 USB

USB is used to transfer data

### 4.1.5 LCD Touchscreen

Interaction with the user takes place by means of a graphical LCD Touchscreen display. The screen can be set to turn off using the screen saver setting, The 861 is always operational if the power is on even if the screen is off. Touch the screen to wake screen up.

## 4.2 HANDHELD

---

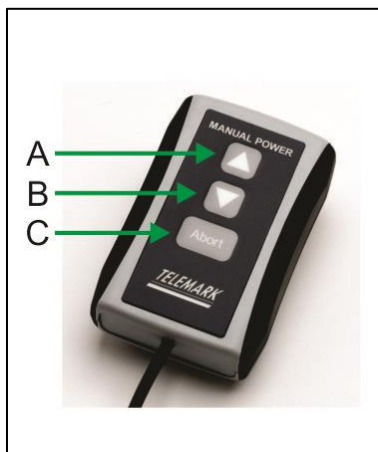

Figure 4-2, Manual Power Handheld

A – Power Increase

B – Power Decrease

C – Abort

## 4.3 TOUCH SCREEN OPERATION

### 4.3.1 Program Menu

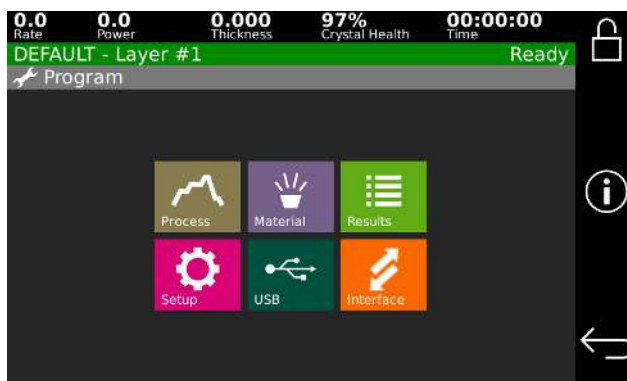

Figure 4-3, Program Menu



Press the Program button to enter the programming mode from the main screen. Pressing one of the six buttons will get you to the next level.

**Process** – Process setup (see chapter 4)

**Material** – Material setup (see chapter 4)

**Results** – Process run history (see below)

**Setup** – System configuration setup (see chapter 4)

**USB** – USB menu for transferring files, it is only active when an USB drive is inserted in the 861 (see below)

**Interface** – Interface displays the sent and received data on the RS-232 port for debugging purposes (see chapter 8)

### 4.3.2 Results

Figure 4-4 shows the results screen. It can display the history of the last 16 process runs. Items displayed are: Run number, Name, Date and time and Status (Normal or Aborted).

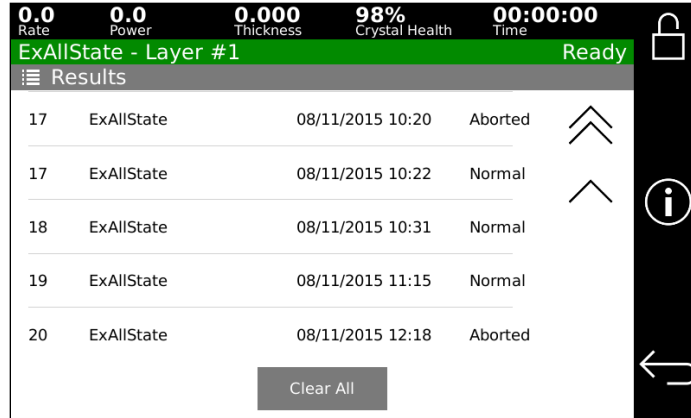

Figure 4-4, Results Screen

### 4.3.3 USB

A standard USB drive (some drives larger than 32GB may not work) may be inserted in the front panel to back up and restore settings and data from the 861.

The USB button on the Program menu is inactive and darkened if no USB drive is inserted. Once a USB drive is inserted in to the front panel it will take several seconds before the USB drive is active. It will be active when the button is no longer darkened.

After selecting USB from the Program menu the USB menu is displayed.

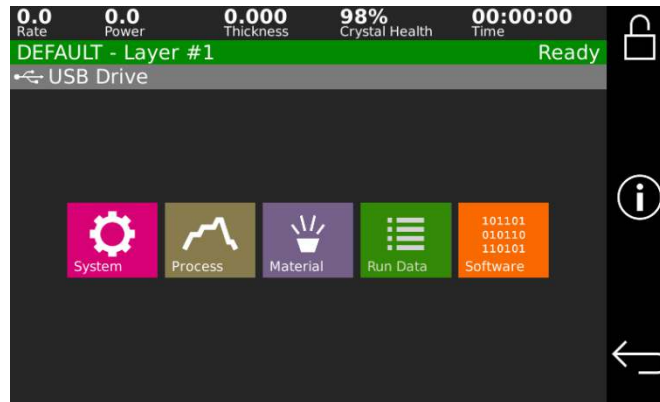
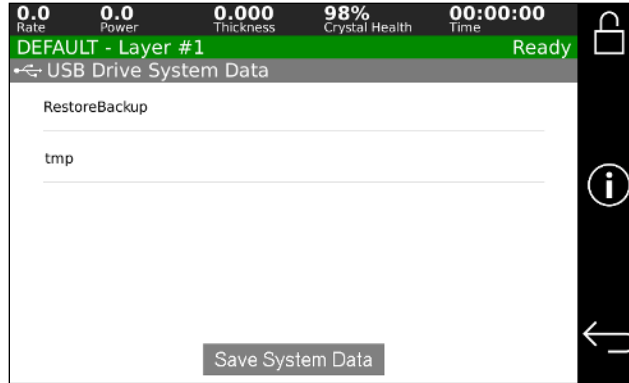

Figure 4-5, USB Menu screen

#### 4.3.3.1 System

Backing up of the system settings is done by touching the gray “Save System Data” button. To restore all the system settings from the USB drive select one of the listed system data sets. **Note Restore will replace all the settings, materials and processes on the current system with the values from the USB drive.**



**Figure 4-6, USB System Backup/Restore**

**4.3.3.2 Process/Material**

Process and material copying are for saving archives and to coping to other 861 systems individual processes and materials. The process and material screens are both laid out the same. The left column shows what is stored on the 861. The right column shows what is stored on the USB drive.

The 861 can also read material and process files created with the old DCM software from 360, 360C and 860 deposition controllers. 360C files on a USB drive are displayed with their extension .FL7 or .PR7. Note file names should be 12 characters in length or less.

To load old 360/860 material files (.FLM) or 360C material files (.FL7) place them in the 861\FILM folder on the USB drive (example d:\861\FILM).

If you want to load old 360/860 process files (.PRC) or 360C process files (.PR7) place them in the 861\PROCESS folder on the USB drive (example d:\861\PROCESS).

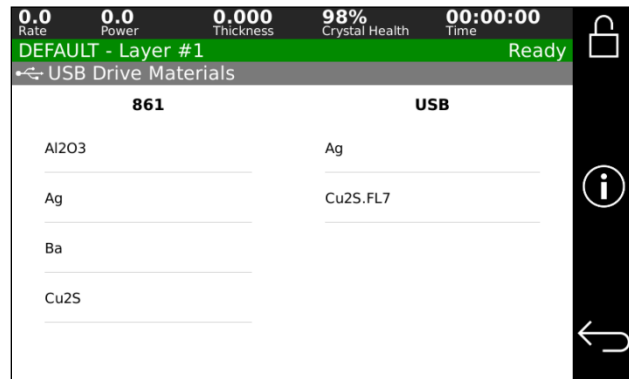

**Figure 4-7, USB Process/Material Backup/Restore**

Touch item on the 861 column to copy it to the USB drive.

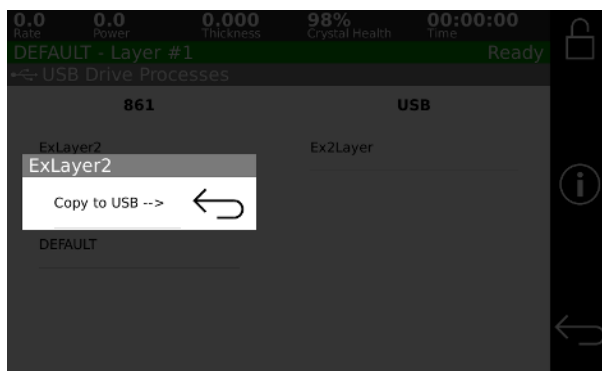

**Figure 4-8, Copy 861 System Data to USB**

Touch an item on the USB column to copy it to the 861 or delete it from the USB drive.

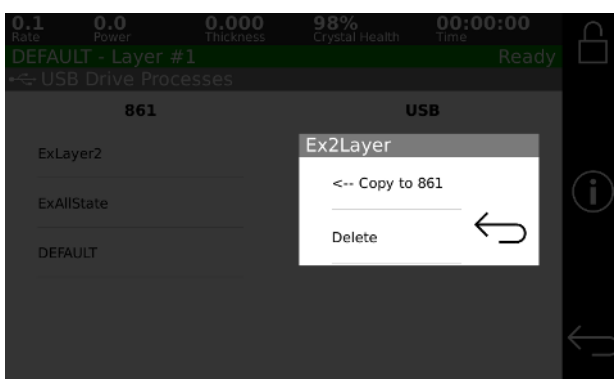

**Figure 4-9, Copy System Data from USB to 861**

### 4.3.3.3 Run Data

Pressing this button will save a text file with the last 16 process runs to the USB drive. It will be saved with a file name with the current time and date in the folder \861\results\. The format is shown below, fields are separated by commas.

Run Number	Status	Start Date Time	Stop Date Time	Data Points/Min	Start Layer	Stop Layer	Process Name
4	Aborted	09/18/2015 09:35:13	09/18/2015 09:35:15	600	1	1	Ex2Layer
5	Normal	09/18/2015 09:43:19	09/18/2015 09:47:51	600	1	1	default

Example:

```
4,Aborted,09/18/2015 09:35:13,09/18/2015 09:35:15,600, 1, 1, Ex2Layer
5,Normal,09/18/2015 09:43:19,09/18/2015 09:47:51,600, 1, 1, default
```

### 4.3.3.4 Software

The 861 system software can be updated via USB drive with software provided by Telemark. Select software version from the displayed list of available on the USB drive. The update should not affect the system settings, materials and processes, but a system back up should be done before the installation just in case. The 861 will ask for confirmation before installing the new software.

### 4.3.4 Right Side Bar Buttons

#### 4.3.4.1 LOCK/UNLOCK BUTTON



The lock/unlock button allows the process, material, and system settings to be password protected with a single password.

The system can be either locked or unlock. In locked mode processes can be run and all settings can be viewed. In unlocked mode all settings can be changed. Pressing the lock icon brings up the Lock dialog window where the system can be locked/unlocked or the password can be changed. The default password is 0000.

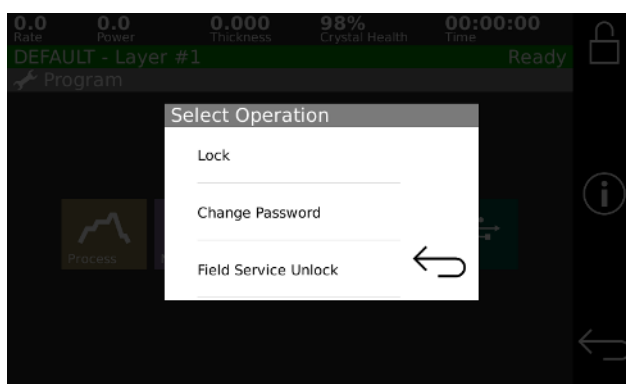

Figure 4-10, Password screen



When using the “ASCII No Checksum” serial interface a remote lock can be activated using the Remote Lock command. This stops the system parameters from being changed. The lock icon on the upper right-hand corner of the touch screen will have an “R” in it when in Remote lock mode. Remote lock is cleared when the 861 is rebooted.

#### 4.3.4.2 SYSTEM INFORMATION BUTTON



Pressing the system information button will display the screen that shows what cards are installed in the 861 and the software version.

### 4.3.4.3 RETURN BUTTON



Pressing the return button will make the system go back to the previous screen.

### 4.3.5 Entering Alpha Characters

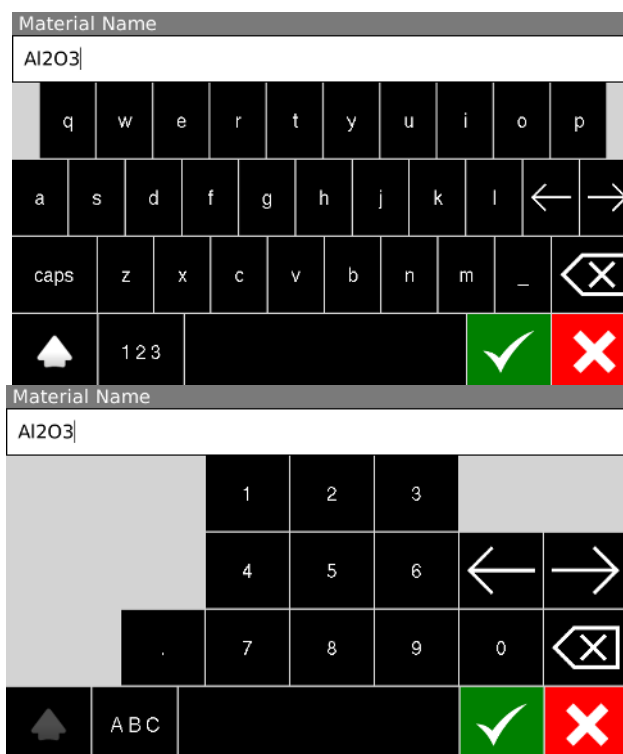
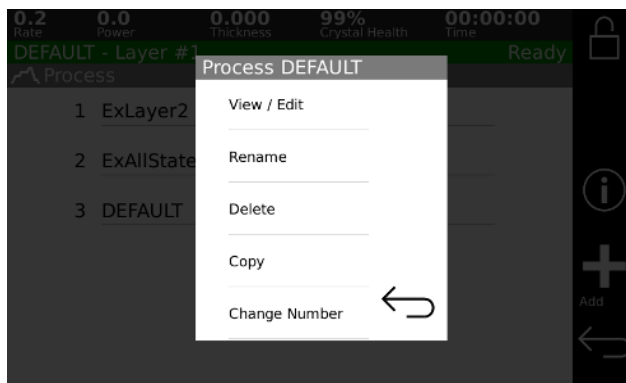

Figure 4-11, Keyboard

The on-screen keyboard is provided to enter upper and lower case alpha characters and numbers.

### 4.3.6 Copying, Deleting and Moving



**Figure 4-12, Copying and Deleting**

A “process” is defined by one or more “layers”, and a layer requires a “material” and a thickness definition. The 861 has the capability of copying and deleting processes and materials. When copying, the new material/process is placed at the end of the list. Change Number menu button can be used to move a material/process to any empty number.



## 5 CONFIGURATION

### 5.1 GETTING STARTED



Figure 5-1, System Setup Menu screen

Once the 861 hardware is installed, the system needs to be programmed for the desired process. The preferred order of programming is:

1. Setup – Display
2. Setup - Utility
3. Setup - Sensor
4. Setup – Source/DAC
5. Setup - Inputs
6. Setup - Outputs
7. Setup - Actions
8. Materials
9. Process

See the Specifications chapter for a list of the possible options for each setting. All settings should be reviewed, of particular note are:

Crystal frequency (5.0 or 6.0 MHz)

Source power supply emission input signal (0 to 2.5, 0 to 5.0 or 0 to 10.0 volts).

Note, in defining sources and sensors the 861 will automatically create the inputs and outputs necessary to complete the interface based on the parameter settings.

Therefore, once the source or sensor settings have been saved, the user should review the inputs and outputs noting the pin assignments so that the proper connections can be made. Also note that the I/O pin assignments can be changed if necessary, in the program input and output screens.

The system will pop up an error if there are not enough inputs or outputs available for the source/sensor configuration when that configuration is saved. The source/sensor configuration must be fixed right away.

## 5.2 SETUP

Choosing the Edit System Setup option from the Main Menu screen will present the System Setup Menu options as shown in figure 5-2. These options allow for setting up the controller to interface with the vacuum system and are described below.

### 5.2.1 Display

Selecting Edit Display Setup will present the Display Setup screen.

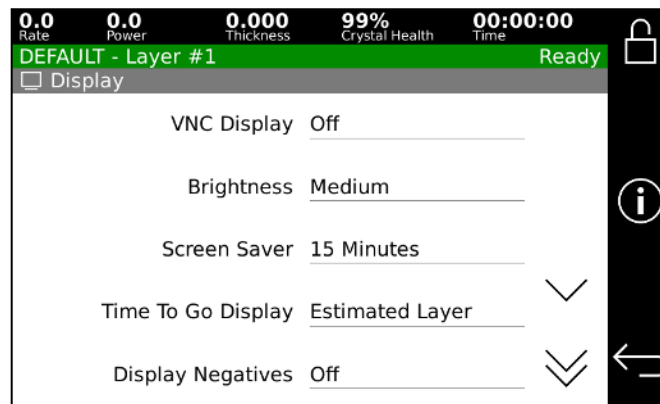
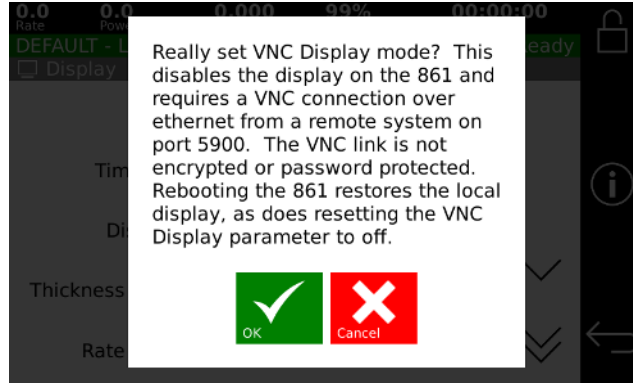

Figure 5-2, Display Setup Screen

#### 5.2.1.1 VNC Display (On/Off)

This parameter determines if the 861 screen is displayed remotely via VNC to a computer that has a VNC viewer running. An Ethernet cable needs to be installed between the back of the 861 and network switch and a computer with VNC. The network needs to have a DHCP server to automatically supply the 861 with an IP address. VNC is a remote operation protocol. Telemark recommends TightVNC for Windows, but any VNC viewer on Windows, Apple, or Linux computer should work.



**Figure 5-3, VNC Warning Screen**

After saving Display Settings changes the 861 screen will turn green and be similar to screen shown below. A beep will sound after 20 seconds; this will indicate that the VNC is ready.

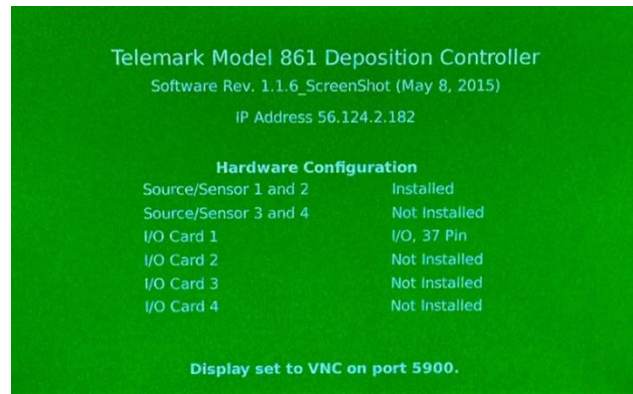

**Figure 5-4, VNC Mode Screen**

When the 861 is ready the VNC connection can be made. Mouse clicks can now control the 861.

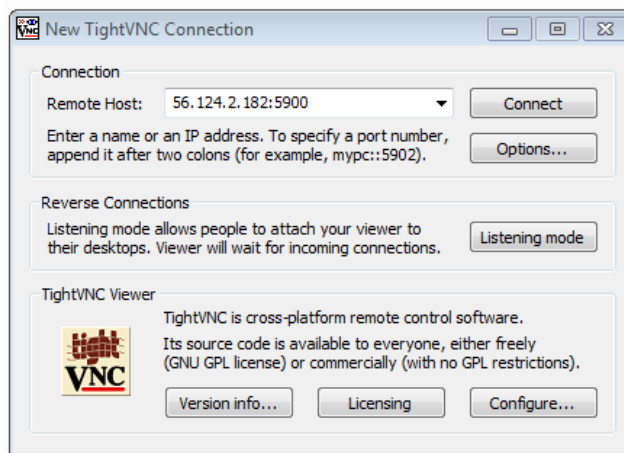

**Figure 5-5, TightVNC Connection in Windows**

The 861 will automatically revert to normal display after a reboot.

### **5.2.1.2 Brightness (Low, Medium, High)**

This parameter controls the brightness of the screen.

### **5.2.1.3 Screen Saver (Off, 5 min, 15min, 1hr, 4 hr)**

This parameter defines the time from last touch of the screen till the screen will be turned off. The 861 is still active when the screen is off. Screen will be turned on if it is touched or there is external input. The screen will stay on when a process is running regardless of then the screen was last touched.

### **5.2.1.4 Time To Go Display (Estimated State, Estimated Layer, Elapsed Process, Elapsed Layer, Elapsed State)**

This parameter defines the displayed value of the Time To Go display on the front panel.

### **5.2.1.5 Display Negatives (On, Off)**

This parameter defines whether the Rate displays a negative numbers. Negative numbers are displayed in Red. When off the smallest number displayed is 0.0.

### **5.2.1.6 Thickness Vs. Time Graph (Enabled, Disabled)**

This parameter defines whether the thickness verses time graph is enabled as one of the status screens.

### **5.2.1.7 Rate Vs. Time Graph (Enabled, Disabled)**

This parameter defines whether the rate verses time graph is enabled as one of the status screens.

### **5.2.1.8 Rate Dev. Vs. Time Graph (Enabled, Disabled)**

This parameter defines whether the rate deviation verses time graph is enabled as one of the status screens.

### **5.2.1.9 Power Vs. Time Graph (Enabled, Disabled)**

This parameter defines whether the power verses time graph is enabled as one of the status screens.

### **5.2.1.10 Source/Sensor Status (Enabled, Disabled)**

This parameter defines whether the source/sensor status screen is enabled as one of the status screens.

### **5.2.1.11 I/O Status (Enabled, Disabled)**

This parameter defines whether the I/O status screen is enabled as one of the status screens.

Note, if all six status screens are disabled, the Rate Vs. Time Graph will be displayed when the Status button is pressed.

### **5.2.1.12 Display Average (sec)**

This parameter controls the averaging of the Rate and Thickness display on the touchscreen. The default is 3 seconds.

### 5.2.1.13 Locale (English, Chinese)

This parameter defines what language is displayed.

### 5.2.1.14 Show Clock Errors (Enabled, Disabled)

This parameter controls the display of clock “low battery” warning.

## 5.2.2 Utility

Selecting the Edit Utility Setup from the Edit System Setup menu will present the Utility Setup screen. Figure 5-6 shows the first page of this screen. All parameters are described below.

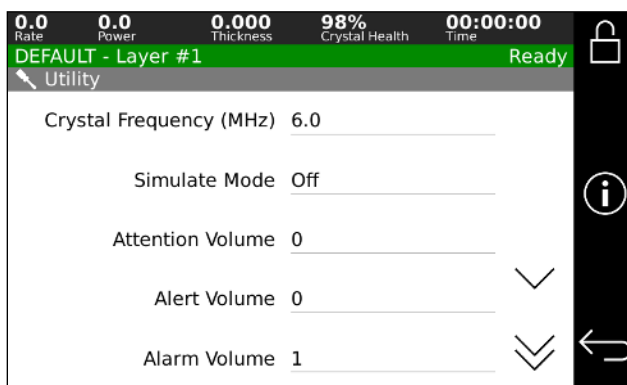

Figure 5-6, Utility Setup screen

### 5.2.2.1 Crystal Frequency (5.0 or 6.0 MHz)

This parameter determines the uncoated crystal frequency type for all sensor inputs. The default setting is 6.0 MHz

### 5.2.2.2 Simulate Mode (On, Off)

This parameter enables or disables the Simulate mode of the controller. The Simulate mode is used for process testing and differs from the Normal mode only to the extent that the Thickness and Rate displays are derived from a simulated sensor input rather than the actual sensor. While in this mode, the simulated thickness build- up is directly proportional to the displayed power level and independent of actual thickness on the sensor. The Simulate mode allows the total deposit process to be simulated. It also allows the tooling factor, density and acoustic impedance calculations to be conveniently checked and altered at the end of the run, if necessary.

### 5.2.2.3 Serial Protocol

This parameter sets the controller’s RS-232 to Standard, ASCII No Checksum, ASCII Checksum, 360C or Mixed Ascii. See serial interface chapters for protocol information.

### 5.2.2.4 Interface Address (1-32)

This parameter sets the controller’s computer interface address for the RS-232 interface.

### **5.2.2.5 Ethernet Configuration (Static, DHCP)**

This parameter sets whether the controller's Ethernet IP address is static or is assigned by a DHCP server.

### **5.2.2.6 IP Address (Static only, xxx.xxx.xxx.xxx)**

This parameter fixes the 861 to a static Ethernet IP address. If used on a companywide network contact your IT department for a number to use so there is no chance of two devices having the same address.

### **5.2.2.7 Subnet Mask (Static only, xxx.xxx.xxx.xxx)**

This parameter sets the 861 subnet mask. The subnet mask is used by the TCP/IP protocol to determine whether a host is on the local subnet or on a remote network. The default is 255.255.255.0

### **5.2.2.8 Attention Volume (0-10)**

This parameter sets the volume of audio attention sound. Attention sounds indicate that the controller is waiting for an operator response or action before continuing the process. A setting of zero disables audio attention sound.

### **5.2.2.9 Alert Volume (0-10)**

This parameter sets the volume of audio alert sound. Alert sounds indicate that a material alert level has been exceeded. A setting of zero disables audio alert sounds.

### **5.2.2.10 Alarm Volume (0-10)**

This parameter sets the volume of audio alarm sound. Alarm sounds indicate that a material alarm level has been exceeded. A setting of zero disables audio alarm sounds.

### **5.2.2.11 Touch Volume (0-10)**

This parameter sets the volume of when you touch the touch screen. A setting of zero disables touch sounds.

### **5.2.2.12 Error Beep Volume (0-10)**

This parameter sets the volume of audio when the touch screen is pressed.

### **5.2.2.13 Pause On Layer Complete (On, Off)**

This parameter determines whether the controller will pause between layers. If this parameter is set to Yes then the controller will stop on layer complete and wait for a Start key press from the operator. If this parameter is set to No then the controller will automatically increment to the next layer.

### **5.2.2.14 Data Points/Min (30 to 600 PPM)**

This parameter sets the number of run-time data point sets per minute that will be written to the process log. The default is 600 data points/minute. During a process, data is logged automatically up to 10 data point sets per minute. This parameter is only visible when the data logging option is installed.

**5.2.2.15 Confirm Saves (Enabled, Disabled)**

This parameter sets whether the 861 asks for conformation to save changes when exiting material, process and system setup.

**5.2.2.16 Input Hold Time (0-5sec)**

This parameter sets the time which is the minimum amount of time an input should be held at true or false before its value is considered settled (valid).

**5.2.2.17 RS232 Use CTS (On, Off)**

This parameter defaults to "Off." This parameter is used for all RS232 interfaces. If set to "On," the 861 waits for the CTS line to be asserted before handling RS232 messages.

**5.2.2.18 RS232 Baud (9600, 19200, 38400, 57600, 115200)**

This parameter sets the RS232 Baud rate. 9600 Baud is recommended. The amount of information sent back and forth is very few bytes, so the baud rate is not going to make much difference. The faster the speed the more the possibility of signal error and the more the cable specifications matter. Particularly the longer the cable is the more this is a problem.

**5.2.2.19 Ave Target Thickness (Enabled, Disabled)**

When this parameter is Enabled, the 861 finishes deposition when the average thickness has reached the target, otherwise the 861 finishes deposition when the most recent thickness sample reaches the target. Default is disabled.

**5.2.2.20 Date (01/01/00-12/31/99)**

This parameter sets the system date in month/day/year format.

**5.2.2.21 Time (00:00-23:59)**

This parameter sets the system time. Time is entered in 24-hour format.

**5.2.3 Sensor**

Selecting Edit Sensor Setup will present the Sensor Setup screen shown in figure 5-7. In this screen you define the sensor parameters that the controller needs to interface to the various types of sensors. Once the sensor setup is complete, the controller will create the necessary inputs and outputs needed to interface to the defined sensors. To define a sensor, select the sensor by touching the desired sensor number. Once selected, the sensor is configured by selecting the appropriate parameters from the right half of the display:



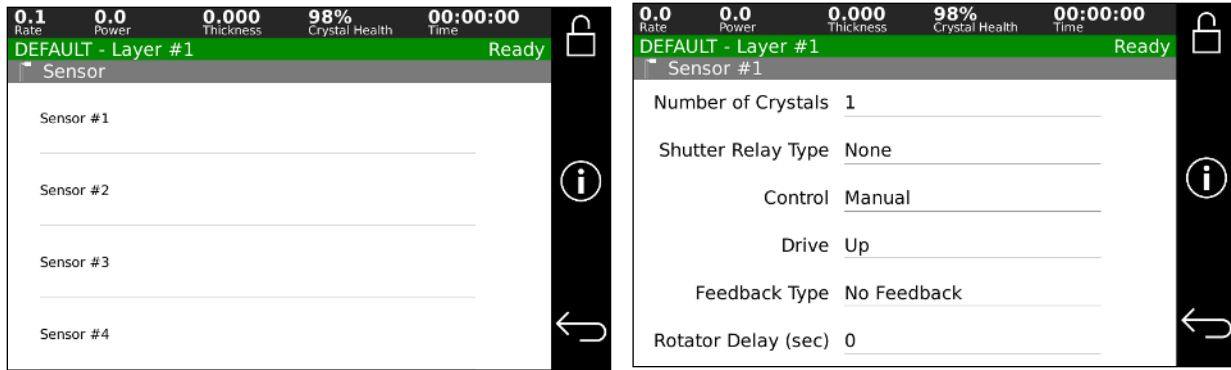

Figure 5-7, Sensor Setup Screen

**5.2.3.1 Number of crystals (1 to 8)**

This parameter defines the number of crystals available for that sensor head. For a single sensor head this would be set to one. For a dual sensor head with separate oscillators and sensor connections, this would still be set to one because there is only one crystal for each sensor input. And, for a multiple rotary type sensor head, this parameter would be set to the number of crystals that the sensor will hold.

**5.2.3.2 Shutter Relay type (N.O., N.C., None, Dual)**

This parameter defines the shutter relay type used to control the sensor shutter. The following four relay types are available:

**N.O.** - Relay is normally open and closes to close shutter. For this type, a “SensorN Shutter” output will be created to interface to the shutter actuator.

**N.C.** - Relay is normally closed and opens to close shutter. For this type, a “SensorN Shutter” output will be created to interface to the shutter actuator.

**None** - No sensor shutter output is created.

**Dual** - Select this type for a dual sensor head. For this type, a “Dual Snsr1&2 Shttr” output will be created to interface to the shutter actuator.

**5.2.3.3 Control (Manual, Direct, Binary 1=00000, Binary=00001, Individual)**

This parameter defines the type of crystal position control utilized. Manual, as it implies, means not under control of the 861. Under manual control, the 861 will stop the process upon the completion of the current layer when the next layer requires a different crystal position. A message prompting the operator with the number of the crystal required is displayed in the Parameter/Status window. Once the crystal has been changed, the process is resumed by pressing the Start button.

Binary 1=00000, Binary 1=00001, and Individual are used when control is through an external crystal rotation controller which accepts Binary inputs or Individual switch closures to select the crystal. The controller creates the number of outputs required to interface with the external controller and set the outputs as required to signal a crystal. Binary 1=00000 and Binary 1=00001 differ by when they start counting the number one. See table 4-1.



"Binary 1=00000" Number	"Binary 1=00001" Number	Binary Bit 4	Binary Bit 3	Binary Bit 2	Binary Bit 1	Binary Bit 0
1	1*	0	0	0	0	0
2	1*	0	0	0	0	1
3	2	0	0	0	1	0
4	3	0	0	0	1	1
5	4	0	0	1	0	0
6	5	0	0	1	0	1
7	6	0	0	1	1	0
8	7	0	0	1	1	1
9	8	0	1	0	0	0
10	9	0	1	0	0	1
11	10	0	1	0	1	0
12	11	0	1	0	1	1
13	12	0	1	1	0	0
14	13	0	1	1	0	1
15	14	0	1	1	1	0
16	15	0	1	1	1	1
17	16	1	0	0	0	0
18	17	1	0	0	0	1
19	18	1	0	0	1	0
20	19	1	0	0	1	1
21	20	1	0	1	0	0
22	21	1	0	1	0	1
23	22	1	0	1	1	0
24	23	1	0	1	1	1
25	24	1	1	0	0	0
26	25	1	1	0	0	1
27	26	1	1	0	1	0
28	27	1	1	0	1	1
29	28	1	1	1	0	0
30	29	1	1	1	0	1
Not used	30	1	1	1	1	0
Not used	Not used	1	1	1	1	1

1 = CLOSED, 0 = OPEN

\* Note in "Binary 1=00001" mode, 00001 and 00000 both equal one.

**Table 4-1, Binary Table**

**5.2.3.4 Drive (Up, Down, Single Step)**

When the Control type is Direct, this parameter defines the drive method or direction. For Up and Down drive types, the controller sets up one output to control a drive motor which is turned on until the rotator reaches the desired position. For Single Step drive type, the controller sets up one output which is singly pulsed for 1.5 seconds to actuate a solenoid to sequentially step the rotator to the desired position. The controller creates one or more of the following outputs depending on the type:

SensorN Drive Up and SensorN Drive Dn

For single step - "Input Hold Time" is added to the pulse off time for single step crystal rotator drive. (So it's 1 second on, (1 + Input Hold Time) seconds off. The "Input Hold Time" setting is in the Setup - Utility menu

**5.2.3.5 Feedback Type (Individual, Binary 1=00000, Binary 1=00001, In Position, No Feedback)**

This parameter defines the type of feedback for a multiple sensor head. The four feedback types available are as follows:

**Individual** - Individual position feedback. This feedback type uses one input for each crystal position in the sensor head.

**Binary 1=00000, Binary 1=00001** - Binary Coded Decimal position feedback. This feedback type uses binary coding to indicate which crystal is in position. See table 4-1

**IN POSITION** - In position feedback. This feedback type uses one input. The input is normally false (open circuit) and should go true (closed to ground) when the desired crystal is in position.

**NO FEEDBACK** - No crystal position feedback is used.

**5.2.3.6 Rotator Delay (0 to 99 seconds)**

This parameter serves two different functions. If the feedback type is "None" (Not recommended). This parameter tells the controller how long to wait assuming the crystal is in position. If position feedback is provided, this parameter tells the controller how long it should wait for the crystal to reach its target position before it issues a Sensor Fault message.

**5.2.4 Source**

Selecting Edit Source Setup will present the Source Setup screen as shown in Figure 5-8. In this screen you select the source setup you wish to edit.

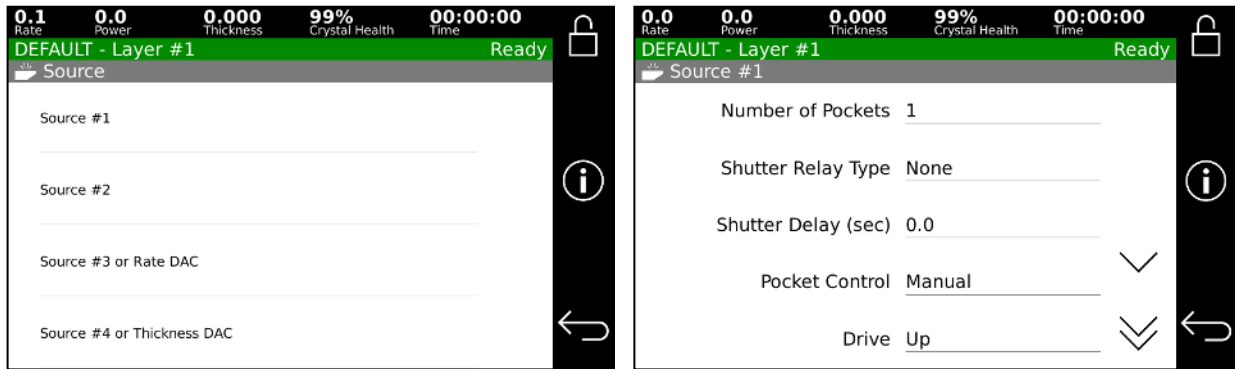

Figure 5-8, Source Setup Screen

Once selected, the source is configured with the following parameters located on the right side of the display:

**5.2.4.1 Source Function (Power, Recorder) (only for Source #3 and #4)**

Power is for normal operation of an EB Source.

Recorder option make Source #3 output Power and Source #4 output Thickness with a 0-5VDC signal. See DAC section for details.

#### **5.2.4.2 Number of Pockets (1 to 30)**

This parameter defines the number of pockets, or crucibles, available for the source. The default value is 1 for a single pocket source.

#### **5.2.4.3 Shutter Relay Type (N.O., N.C., None)**

This parameter defines the shutter relay type used to control the source shutter. The following three relay types are available:

**N.O.** - Relay is normally open and closes to close shutter. For this type, a "SourceN Shutter" output will be created to interface to the shutter actuator.

**N.C.** - Relay is normally closed and opens to close shutter. For this type, a "SourceN Shutter" output will be created to interface to the shutter actuator.

**None** - No source shutter output is created.

#### **5.2.4.4 Shutter Delay (sec) (0.0 to 9.9 seconds)**

This parameter defines the amount of time allowed for the source shutter to open, after which the process will timeout if the necessary feedback has not been set. During Shutter Delay the power setting of "Predeposit Hold" or the final power setting in "Rate Establish" is held as a constant.

#### **5.2.4.5 Control (Manual, Direct, Binary 1=00000, Binary=00001, Individual)**

This parameter defines the type of pocket control utilized. Manual, as it implies, means not under control of the 861. Under manual control, the 861 will stop the process upon the completion of the current layer when the next layer requires a different pocket. A message prompting the operator with the material required is displayed in the Parameter/Status window. Once the pocket has been changed, the process is resumed by pressing the Start button. See table 4-1

Binary 1=00000, Binary 1=00001, and Individual are used when control is through an external pocket rotation controller which accepts Binary inputs or Individual switch closures to select the pocket. The controller creates the number of outputs required to interface with the external controller and sets the outputs as required to signal a pocket change. Binary 1=00000 and Binary 1=00001 differ by when they start counting the number one. See table 4-1.

The controller sets up one or two outputs, one for each available direction, to drive a motor or solenoid. Direct is used when the actuating device is driven directly. In this case the controller setups up one or two outputs, one for each available direction, to drive a motor or solenoid.

#### **5.2.4.6 Drive (Up, Down)**

When the Control type is Direct, this parameter defines the drive method or direction. For Up and Down drive types, the controller sets up one output to control a drive motor which is turned on until the rotator reaches the desired position.

The controller creates one or more of the following outputs depending on the type:

Drive Up  
Drive Down

#### **5.2.4.7 Feedback Type (Individual, Binary 1=00000, Binary 1=00001, In Position, No Feedback)**

This parameter defines the type of feedback for a multiple pocket source. The five feedback types available are as follows:

**Individual** - Individual position feedback. This feedback type uses one input for each pocket position in the source.

**Binary 1=00000, Binary 1=00001** - Binary position feedback. This feedback type uses binary coding to indicate the pocket position. See table 4-1.

**In Position** - In position feedback. This feedback type uses one input. The input is normally false (open circuit) and should go true (closed to ground) when a pocket is in position.

**No Feedback** - No pocket position feedback is used.

#### **5.2.4.8 Feedback Pause (0 to 10 seconds)**

This parameter may be needed for systems that slow down the "In Position" signaling between the indexer and the 861 (such as when the signal goes through an intermediate process controller). This pause defaults to 1 sec.

#### **5.2.4.9 Pocket Delay (0 to 99 seconds)**

This parameter serves two different functions. If the feedback type is "None" (Not recommended, see cautions in the Installation section.) this parameter tells the controller how long to wait, on the assumption the pocket will get into position. If position feedback is provided, this parameter tells the controller how long it should wait for the pocket to reach its target position before it issues a Source Fault message.

#### **5.2.4.10 Source Voltage (2.5V, 5.0V, 10V)**

This parameter sets the upper voltage range for the source control output. The lower voltage range is always 0. For example, selecting 10 for this parameter sets the source control voltage range from 0 to 10 volts.

#### **5.2.4.11 Sweep Control (None, Binary 1=00000, Binary 1=00001, Individual)**

This parameter defines the type of XY sweep control utilized. None means not under control of the 861. Binary 1=00000, Binary 1=00001, and Individual are used when a XY sweep pattern is selected via the settings in the material setup. The signals are sent to a XY sweep which accepts Binary inputs or which uses Individual switch closures to select the sweep pattern. Binary 1=00000 and Binary 1=00001 differ by where they start counting the number one. See table 4-1

#### **5.2.4.12 Number of Sweep Patterns (0-63) (not shown if Sweep Control is none)**

This number is used to determine the number of 861 outputs that are generated and sets the maximum allowed sweep number.

**5.2.4.13 Sweep Feedback Type (No Feedback, Ready) (not shown if Sweep Control is none)**

This parameter determines if there is no feedback or a sweep ready signal.

**5.2.4.14 Sweep Delay (0 to 99 sec) (not shown if Sweep Control is none)**

This parameter tells the controller how long to wait for the XY sweep get ready. If sweep feedback is provided, this parameter tells the controller how long it should wait for the sweep to get ready before it issues a sweep Fault message.

**5.2.5 DAC**

When Source #3 and #4 are in Recorder mode the following options are available.

Source #3 or Rate DAC: Disabled, 2-Digit, 3-Digit

Source #4 or Thickness DAC: Disabled, 2-Digit, 3-Digit, Target Thickness

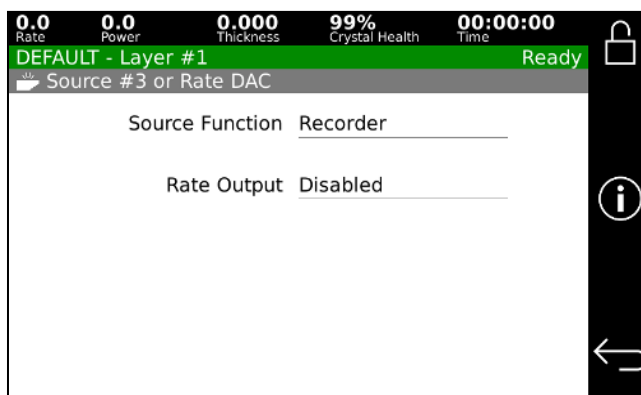

**Figure 5-9, DAC Setup screen**

The 861 has one rate and one thickness DAC output, which are suitable for recording with a strip chart recorder or other recording device. Each DAC converts the last two or three digits of the appropriate display to a 0 to 5 volt analog signal. When 5 volts is reached the voltage drops back to 0 then increases from there. See graphical explanation below.

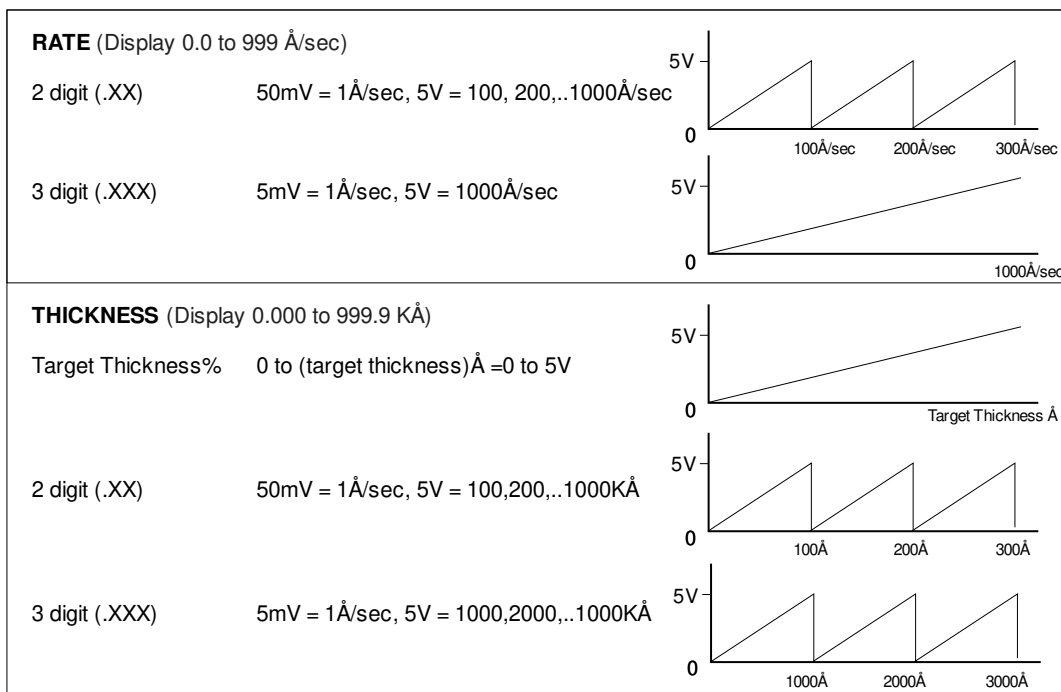

Figure 5-10, DAC Rate and Thickness

## 5.2.6 Inputs

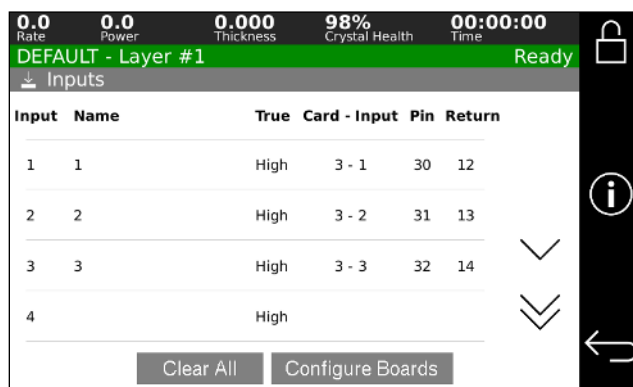

Figure 5-11, Program Inputs

The controller has ‘logical’ discrete inputs which are used when running a process, and ‘physical’ discrete inputs at the rear-panel connector pins which can be associated arbitrarily by the user with the logical inputs using the Edit Program Inputs function. By itself a user defined input has no effect, it can only be useful when its logical state is used as a condition for an internal action, or an external action represented by the state of a discrete output.

### 5.2.6.1 INPUT TYPE

The controller provides for a maximum of 32 logical inputs. The logical inputs can be associated with up to 8 physical inputs with the single I/O card provided with the basic controller, and with up to 32 physical inputs if the maximum of 4 I/O cards are installed.

The logical discrete inputs have two types:

1. Inputs that are named and assigned by the user
2. Inputs that are automatically defined by the controller, such as those required for source and sensor position feedback, and these cannot be changed by the user.

User defined logical input (1 to 32) can be given a 16-digit name, and can be associated with a physical input by identifying the I/O card (1 to 4) and connector pin number (each of which also has a separate pin for the signal return which is displayed to the right of the Pin#). The input's true level can also be defined for each input. An input defined as High true will be true when the input's voltage is at or above the high level for the particular I/O card installed.

When the controller defines inputs, it selects the blank names remaining in the logical input list and assigns them in sequence to the internally generated functions. For this reason, it is important that unused inputs are left blank, and that there are sufficient inputs for all required functions.

### 5.2.6.2 PASSIVE/ACTIVE

Input cards can be set to use Passive or Active inputs. For the 37 pin I/O card go to chapter to see the hardware jumpers setting. For the 25 Input card press the "Configure Boards" button on the Input screen to get to the screen shown in figure 5-7, where passive mode can be set On or Off for each board installed.

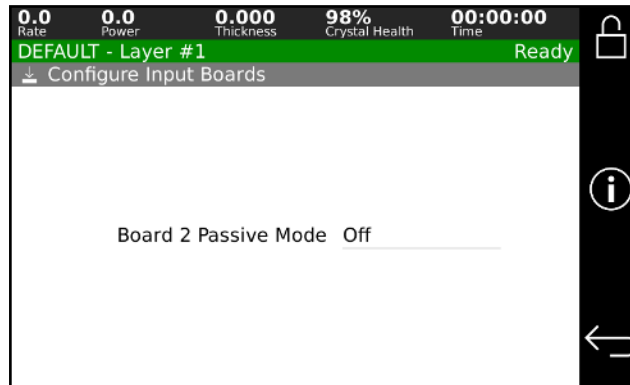
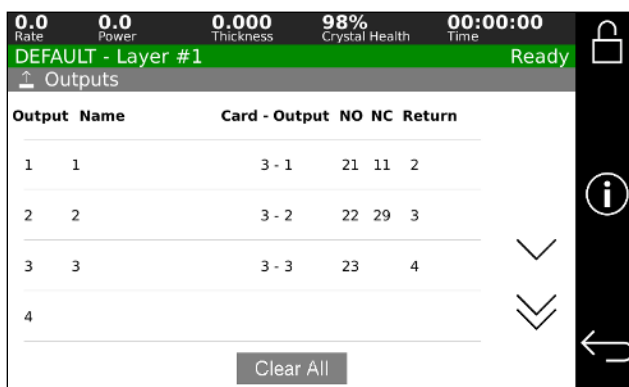

Figure 5-12, 25 pin Card, Passive/Active Setting

Passive inputs have TTL level (0 to 5 volt DC) inputs. The Passive inputs are pulled up to 5 volts internally through a resistor and are set true, assuming the input's True level is set to Low, by shorting the input pins together.

Active inputs have 12 to 24 volt DC inputs. The Active inputs are set true, assuming the input's true level is set to High, by supplying 12 to 24 volt AC or DC across the input pins.

## 5.2.7 Outputs



**Figure 5-13, Output screen**

The controller has “logical” discrete outputs which are used when running a process, and “physical” discrete outputs which can be associated arbitrarily by the user with the logical outputs using the Program Outputs function. Each physical discrete output is in the form of a pair of relay contacts assigned to dedicated pins on a controller back-panel connector, and these contacts will close when a the logical discrete output associated with the physical output satisfies a set of conditions defined by the user

The controller provides for a maximum of 32 logical outputs. The logical outputs can be associated with up to 8 physical outputs with the single I/O card provided with the basic controller, and with up to 32 physical outputs if the maximum of 4 I/O cards are installed. Additionally, 37 pin I/O card has a relay output which is dedicated to the Abort function.

A logical output (01 to 32) can be given a 16-digit name and can be associated with a physical output by identifying the I/O card (1 to 32) and connector pin number.

### OUTPUT TYPE

The logical discrete outputs have two types:

1. Outputs that are named and assigned by the user
2. Outputs that are automatically defined by the controller, such as those required for source and sensor rotator controls, and these cannot be changed by the user. These internally defined outputs are indicated by a condition string labeled “Internally Defined”

When the controller defines outputs, it selects the blank names remaining in the logical output list and assigns them in sequence to the internally generated functions. For this reason, it is important that unused outputs are left blank, and that there are sufficient outputs for all required functions. Outputs that are internally defined are discussed further in the source/sensor setup sections.

Two screens are required to program the Discrete outputs. The first screen provides for selecting the output to be programmed, while the second screen provides for the actual programming, including the output name.



Selecting Program Outputs from the System Setup menu will present the Select Output screen. Touching an Output from this screen will provide access to the Output Name, Card#, Pin# and Condition string edit fields. A 12-digit name can be assigned to the logical input.

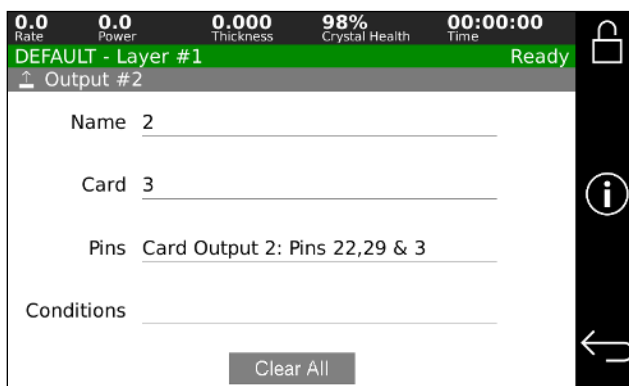

**Figure 5-14, Program Output Screen**

The output condition string is a logical statement that determines the state of the output. The output relay is closed when the condition string is evaluated as true. Otherwise, the relay is open

### 5.2.7.1 ENTERING A CONDITION STRING

A condition string comprises one or more individual conditions linked together by the logical operators ! NOT, & AND, | OR and parentheses ( ). Conditions are chosen from a list. To enter a condition string correctly you must follow these rules:

There must be an equal number of closed and open parentheses. Parentheses must contain valid condition strings and may not be empty.

All conditions must be separated by either the & or the | operator.

Condition strings cannot begin or end with an operator.

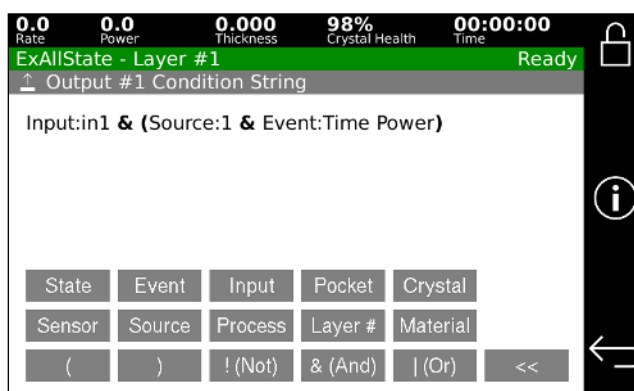

**Figure 5-15, Program Output Screen**

To enter a condition string, touch the “Condition” field. Then select the desired conditions from the gray buttons at the bottom of the screen.

**5.2.7.2 CONDITION TYPES**

**A. States**

State conditions are evaluated true whenever the controller is in the respective state. Controller States are:

Int
Process Ready
Start Process
Start Layer
Change Pocket
Change Crystal
Layer Ready
Soak Rise
Soak Hold
Predeposit Rise
Predeposit Hold
Establish Rate
Shutter Delay
Deposit 1
Rate Ramp 1
Deposit 2
Rate Ramp 2
Deposit 3
Rate Ramp 3
Deposit 4
Rate Ramp 4
Deposit 5
Ramp To Feed
Feed
Ramp To Idle
Layer Complete
Process Complete
Process Resume

**B. Events**

Event conditions are evaluated true whenever the respective event is true. Controller Events are:

Abort
Halt
Hold
Time Power
Ready

In Process
Simulate
Time Setpoint
Last Layer
Crystal Failure
Crystal Marginal
Min Rate&Max Pwr
Max Rate&Min Pwr
Rate Dev. Alarm
Rate Est. Error
Rate Dev. Alert
Max. Power Alert
Min Power Alert
Rate Dev. Atten.
Max Power Atten.
Min Power Atten.
Manual Power

### C. Inputs

Input conditions are represented by the user defined programmable inputs. A condition is either true or false depending on the state of the input. Inputs are considered true when pulled to logic ground.

### D. Process

The process condition is evaluated true whenever the selected process is the current process.

Material	The material condition is evaluated true whenever the selected material is the current material.
Sensor (1-4)	The sensor condition is evaluated true whenever the current sensor equals the specified sensor.
Crystal (1-8)	The crystal condition is evaluated true whenever the current crystal equals the specified crystal.
Source (1-4)	The source condition is evaluated true whenever the current source equals the specified source.
Pocket (1-30)	The pocket condition is evaluated true whenever the current pocket equals the specified pocket.
Layer (1-999)	The layer condition is evaluated true whenever the current layer# equals the specified layer#.

### 5.2.8 Actions

The 861 provides for 16 internal user programmable actions. Internal actions are used to provide special functions at the true evaluation of a condition string. These functions may be such things as terminating a deposit on an input from an optical monitor. Or, sounding an alarm when certain events are true.

To program an action, first select the desired action from the list of 16 programmable actions displayed in the Actions screen.

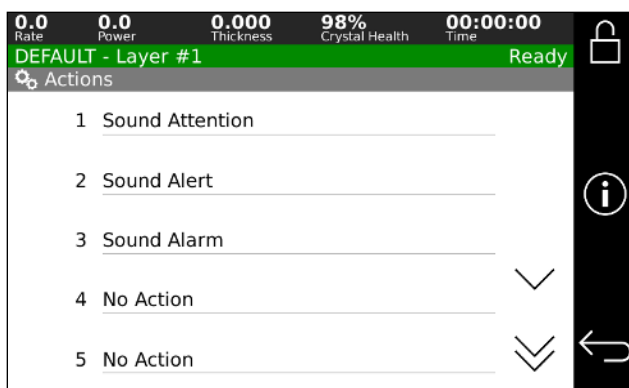

**Figure 5-16, Actions List**

Once you have selected the required action, press “Action Name.”

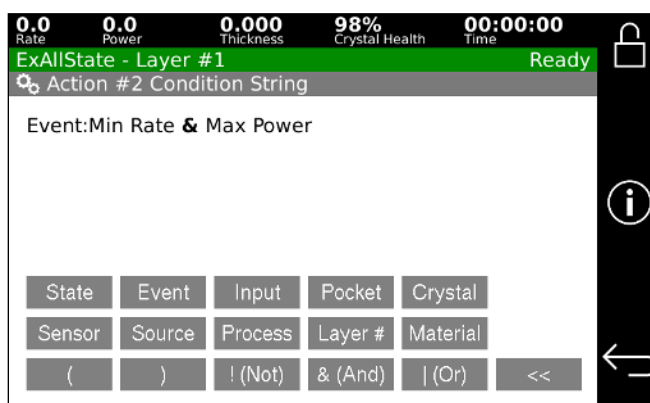

**Figure 5-17, Action Setup**

In this screen select the predefined action you would like.

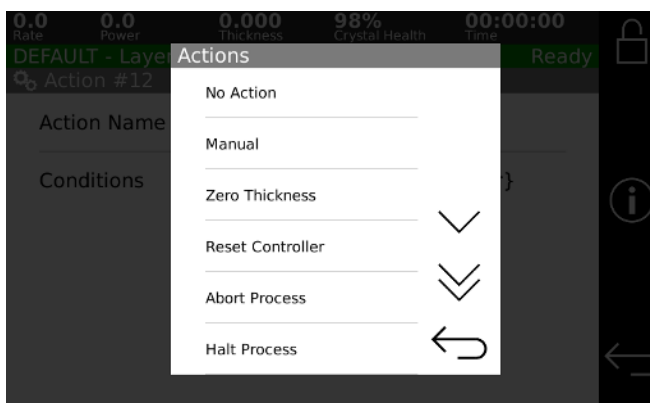

**Figure 5-18, Action Selection**

The following is a list of the predefined actions:

No Action	No action is taken. The default setting.
Manual	Functionally identical to pressing Manual button.
Zero	Functionally identical to pressing Zero button.
Reset	Functionally identical to pressing Reset button.

Abort	Functionally identical to pressing Abort button.
Halt	Halts the process, sets active source power to idle, and leaves all other source powers unchanged.
Terminate Deposit	Triggers the final thickness for the deposit state. Action is ignored if state is not a deposit state.
Hold In State	Holds controller in current state for the following states: ChangePocket, ChangeCrystal, SetSoakSweep, SoakRise, SoakHold, SetPredepositSweep, PredepositRise, PredepositHold, SetDepositionSweep, SetFeedSweep, RampToFeed, Feed, RampToIdle.
Sound Attention	Triggers the attention sound and displays the "Attention Action" message in the State/Trouble field in the Parameter/Status display.
Sound Alert	Triggers the Alert sound and displays the "Alert Action" message in the State/Trouble field in the Parameter/Status display.
Sound Alarm	Triggers the Alarm sound and displays the message "Alarm Action" in the State/Trouble field of the Parameter/Status display.
Start Process	Trigger the start of the currently selected process. This action is ignored unless the controller is in the Process Ready state.
Select Process 1-8	Select process #1-8 as the next process to be started by the Start Process action described above.
Switch Crystals	Toggles between the primary and the backup sensor/crystal combination defined by the active material.

Once the action is selected then you need to establish when the action should take place by defining its condition string. This is covered in the earlier Output section.

### 5.3 MATERIAL

From the Main Menu, selecting View/Edit Material will present the Select Material screen shown below.

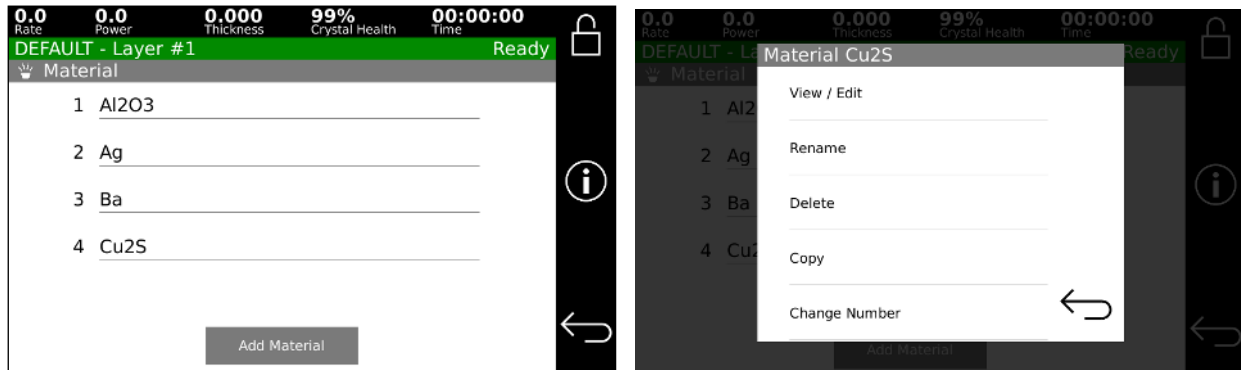

Figure 5-19, Select Material screen

#### 5.3.1 Define A Material

Selecting a material for viewing and/or editing will present the screen which permits the material to be defined. In this screen, you define all of the material parameters for the selected material. The material parameters are described in detail below.

##### 1. Material Name (A 12 character material name)

An existing material can be renamed from the menu choice "Rename" that is displayed when the material is selected.

Select “Add Material” button to add a new material. This will display a complete list of materials that are stored in the 861. The first item “New Material” will wait for a name to be input.

If a predefined material is chosen, the stored values for the density and acoustic impedance for that material are automatically entered into their respective parameters.

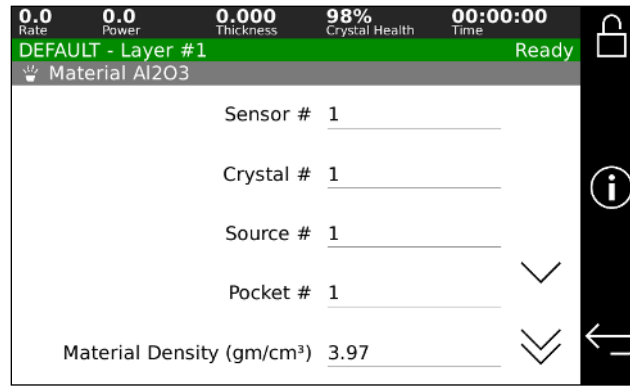

Figure 5-20, Define Material screen

## 2. Thickness (000.0 to 999.9 kÅ)

This parameter can be used in three different ways described below. The default for this parameter is 0.000 K ang.

- If a process layer has a thickness greater than 0.000 then the value in the material will be ignored.
- If the process layer has a thickness of 0.000 then value in the material will be used.
- When “Select Film” is used the material thickness is used as the stopping point.

### 5.3.1.1 Sensor# (1 to 4)

This parameter defines the sensor input number that will be used for this material, and cannot be greater than the number of sensor inputs fitted to the controller. The default setting is 1.

### 5.3.1.2 Crystal# (1 to 8)

This parameter defines the primary crystal used to monitor this material. This parameter cannot be greater than the Number of Crystals parameter in the Sensor Setup screen. The default setting is 1.

### 5.3.1.3 Source# (1 to 4)

This parameter defines the source output number that will be used for this material, and cannot be greater than the number of source outputs fitted to the controller. The default setting is 1.

### 5.3.1.4 Pocket# (1 to 30)

This parameter defines the pocket number that contains this material. This parameter cannot be greater than the Number of Pockets parameter in the Source Setup screen. The default setting is 1.

### 5.3.1.5 Density (0.80 to 99.99 gm/cm<sup>3</sup>)

This parameter provides the material density so that the controller can calculate and display the physical film thickness. If the film density is known it should be used. A list of the more commonly used film densities is available in pdf form on the supplied CD. As a first approximation, bulk material density can be used in programming. Empirical calibration of this parameter is described in chapter 6.

### 5.3.1.6 Acoustic Impedance (5.00 to 90 gm/cm<sup>2</sup>/sec)

This parameter is the acoustic impedance of the material. The acoustic impedance of the deposited film is required by the 861 in order to accurately establish the sensor scale factor when the sensor crystal is heavily loaded. If the acoustic impedance of the film material is known, it can be entered directly in units of 10<sup>5</sup> gm/cm<sup>2</sup> sec. In most cases the acoustic impedance of the bulk material can be used and can be obtained from The Handbook of Physics or other source of acoustic data. The shear wave impedance should be used. The shear wave acoustic impedance can be calculated from the shear modulus or the shear wave velocity and the density by using the following equation:

$$AI = \rho \cdot C = \sqrt{\rho \cdot G}$$

Where:

AI= Acoustic Impedance

$\rho$  = Density (gm/cm<sup>3</sup>)

C= Transverse (shear) wave velocity (cm/sec)

G= Shear Modulus (dynes/cm<sup>2</sup>).

A list of the acoustic impedance and density of the more commonly deposited materials is available in pdf form on the supplied CD and a technique for empirically determining this parameter is presented in chapter 6.

In many cases and particularly if the sensor crystal is not heavily loaded, sufficient accuracy can be achieved by using the acoustic impedance of quartz which is 8.83 X 10<sup>5</sup> gm/cm<sup>2</sup> sec.

### 5.3.1.7 Tooling Factor (10.0 to 499.9%)

This parameter is the tooling factor for the primary sensor. The Tooling Factor parameter is used to compensate for geometric factors in the deposition system which result in a difference between the deposition rate on the substrates and the rate on the sensing crystal. This parameter is entered in percent units and 100% corresponds to equal rates at the substrate and at the sensing crystal. To a first approximation the tooling factor can be calculated using the following equation:

$$Tooling\% = \left( \frac{dc}{ds} \right)^2 \cdot 100$$

where:

dc= Distance from source to crystal.

ds= Distance from source to substrate.

Empirical calibration of the tooling factor is described in Section 7.2.2.

#### **5.3.1.8 Proportional Gain (0 to 9999)**

This parameter is the proportional gain factor for the source power control loop.

#### **5.3.1.9 Integral Time constant (0 to 99.9 sec)**

This parameter is the system time constant.

#### **5.3.1.10 Derivative Time constant (0 to 99.9 sec)**

This parameter is the system dead time.

#### **5.3.1.11 Rise To Soak Time (0 to 9:59:59)**

This parameter sets the time interval for the source power to ramp up from zero to the power level set in Soak Power parameter. It should be long enough for the material to have time to reach equilibrium temperature without spitting, or in the case of evaporation sources, protected from unnecessary thermal shock.

#### **5.3.1.12 Soak Power (0.0-99.9%)**

This parameter defines the source power level during the Soak state. The Soak Power should be established at a level which will assure that the source material is properly outgassed and prepared for subsequent deposition.

#### **5.3.1.13 Soak Time (0 to 9:59:59)**

The Soak Time parameter defines the time duration of the Soak state. It is used in conjunction with the Soak Power to allow the material to fully outgas.

#### **5.3.1.14 Soak Sweep Pattern (0 to 63)**

This parameter selects a XY sweep pattern for the soak state. Once a pattern is selected that pattern will continue to be output till a new pattern from 1 to 63 is selected. When "0" is selected, no change in pattern output is made. A XY Sweep is configured in the source setup.

#### **5.3.1.15 Rise To Predeposit (0 to 9:59:59)**

This parameter sets the time interval for the source power to ramp from Soak Power level to the Predeposit Power.

#### **5.3.1.16 Predeposit Power (0.0 to 99.9%)**

This parameter defines the source power level during the Predeposit state. This should be set as close as possible to the power level required to reach the desired deposition rate. The Manual mode can be used to conveniently determine the Soak and Predeposit power levels of a particular material.

#### **5.3.1.17 Predeposit Time (0 to 9:59:59)**

This parameter defines the time duration of the Predeposit state. The Predeposit Time should be established at a value which allows the source material to be brought to the deposit temperature level and stabilized in an orderly manner. Since evaporation will



normally occur at the Predeposit power level, too long a Predeposit Time will result in unnecessary buildup of material on the shutter and unnecessary material loss.

#### **5.3.1.18 Predeposit Sweep Pattern (0 to 63)**

This parameter selects a XY sweep pattern for the Predeposit state. Once a pattern is selected that pattern will continue to be output till a new pattern from 1 to 63 is selected. When "0" is selected, no change in pattern output is made. A XY Sweep is configured in the source setup.

#### **5.3.1.19 Rate Establish Time (0, 6 to 5999 seconds)**

This parameter defines the time limit of the rate establish state. The rate establish state occurs before the deposit state and is used to establish the correct source power before the source shutter is opened. In the rate establish state the crystal shutter is opened, the source shutter is closed, and the controller is controlling source power to achieve the programmed rate within the Rate Establish Error% for a period of 5 seconds. Once the rate has been held within limit for 5 seconds, the controller will go into the deposit state. If the rate error cannot be held within the allowed percentage error for 5 seconds, then the controller will display a Rate Establish Error and the process will be halted.

For the rate establish function to work, the sensor must be located somewhere in the vapor stream of the source while the source shutter is closed. The default setting for this parameter is 0 which disables this function.

#### **5.3.1.20 Rate Establish Err% (0 to 99%)**

This parameter sets a maximum limit for the rate establish error, which must not be exceeded for a five-second period during the rate establish state, in order for the controller to enter the deposit state.

#### **5.3.1.21 Deposit Rate #1 (0.0 to 999.9 Å/sec)**

This parameter defines the first deposition rate.

#### **5.3.1.22 Rate Ramp (Disabled, Thickness (kÅ), Thickness (%))**

This parameter defines the rate ramp type. If disabled the Deposition ramps will not show, if Thickness (kÅ) is selected the ramps will be based on Angstroms. If Thickness (%) is selected the ramps will be based on percent of the current layer thickness.

#### **5.3.1.23 Rate Ramp Start #1 (0.000 to 999.9 kÅ or 0 to 100%)**

This parameter determines the thickness value to trigger the start of the first rate ramp. A value of 999.9 will disable the rate ramp function and the Rate Ramp Stop will be hidden. Please note that all the Rate Ramp Start parameters can also be used as thickness setpoints for triggering I/O events.

#### **5.3.1.24 Rate Ramp Stop #1 (0.000 to 999.9 kÅ or 0 to 100%)**

This parameter defines the ending thickness for rate ramp #1. Hidden if Rate Ramp Start #1 is 999.9 Å or 100%

#### **5.3.1.25 Deposit Rate #2 (0.0 to 999.9 Å/sec)**

This parameter defines the second rate.

**5.3.1.26 Rate Ramp Start #2 (0.000 to 999.9 kÅ or 0 to 100%)**

This parameter determines the thickness value to trigger the start of the second rate ramp. A value of 999.9 will disable the rate ramp function. Hidden if Deposit Rate #2 is 0.0

**5.3.1.27 Rate Ramp Stop #2 (0.000 to 999.9 kÅ or 0 to 100%)**

This parameter defines the ending thickness for rate ramp #2. Hidden if Rate Ramp Start #2 is 999.9 Å or 100%

**5.3.1.28 Deposit Rate #3 (0.0 to 999.9 Å/sec)**

This parameter defines the third deposition rate. Hidden if Deposit Rate #2 is 0.0

**5.3.1.29 Rate Ramp Start #3 (0.000 to 999.9 kÅ or 0 to 100%)**

This parameter determines the thickness value to trigger the start of the third rate ramp. A value of 999.9 Å or 100% will disable the rate ramp function. Hidden if Deposit Rate #3 is 0.0

**5.3.1.30 Rate Ramp Stop #3 (0.000 to 999.9 kÅ or 0 to 100%)**

This parameter defines the ending thickness for rate ramp #3. Hidden if Rate Ramp Start #3 is 999.9 Å or 100%

**5.3.1.31 Deposit Rate #4 (0.0 to 999.9 Å/sec)**

This parameter defines the fourth deposition rate. Hidden if Deposit Rate #3 is 0.0

**5.3.1.32 Rate Ramp Start #4 (0.000 to 999.9 kÅ or 0 to 100%)**

This parameter determines the thickness value to trigger the start of the fourth rate ramp. A value of 999.9 Å or 100% will disable the rate ramp function. Hidden if Deposit Rate #4 is 0.0

**5.3.1.33 Rate Ramp Stop #4 (0.000 to 999.9 kÅ or 0 to 100%)**

This parameter defines the ending thickness for rate ramp #4. Hidden if Rate Ramp Start #4 is 999.9 Å or 100%

**5.3.1.34 Deposit Rate #5 (0.0 to 999.9 Å/sec)**

This parameter defines the fifth deposition rate. Hidden if Deposit Rate #4 is 0.0

**5.3.1.35 Deposition Sweep Pattern (0 to 63)**

This parameter selects a XY sweep pattern for the Deposition state. Once a pattern is selected that pattern will continue to be output till a new pattern from 1 to 63 is selected. When "0" is selected, no change in pattern output is made. A XY Sweep is configured in the source setup.

**5.3.1.36 Time Setpoint (0 to 9:59:59)**

This parameter defines the time from the start of the layer until the time setpoint event is triggered.

**5.3.1.37 Feed Enabled (Enabled, Disabled)**

This parameter defines whether the Feed parameters are displayed and used

**5.3.1.38 Ramp To Feed Time (if Feed Enabled, 0 to 9:59:59)**

This parameter defines the time allowed for the source power to go from the last deposition power to the Feed Power. The default for this parameter is zero.

**5.3.1.39 Feed Power (if Feed Enabled, 00.0 to 99.9%)**

The Feed Power parameter defines the source power level during the feed state.

**5.3.1.40 Feed Time (if Feed Enabled, 0 to 9:59:59)**

The Feed Time parameter sets the feed time. This parameter can also be used as a delay between the deposit state and the idle state. The default for this parameter is zero which disables the feed function.

**5.3.1.41 Feed Sweep Pattern (if Feed Enabled, 0 to 63)**

This parameter selects a XY sweep pattern for the Feed state. Once a pattern is selected that pattern will continue to be output till a new pattern from 1 to 63 is selected. When "0" is selected, no change in pattern output is made. A XY Sweep is configured in the source setup.

**5.3.1.42 Ramp To Idle Time (0 to 9:59:59)**

This parameter defines the time allowed for the source power to go from the last deposition power or feed power to the Idle Power. The default for this parameter is zero.

**5.3.1.43 Idle Power (00.0 to 99.9%)**

This parameter defines the source power after the feed or deposit states until the next Soak or abort state. If the idle power is greater than zero then the next layer using this source and pocket will start from the Predeposit state. If any subsequent layer uses the same source but a different pocket, the idle power will be automatically set to zero.

**5.3.1.44 Maximum Power (00.0 to 99.9%)**

The maximum power parameter sets the maximum allowable source power for this material. The deposition power will not be allowed to exceed this value.

**5.3.1.45 Power Alarm Delay (0 to 99)**

This parameter sets the time required for the deposit power to be at Maximum or Minimum power before the alarm will be triggered.

**5.3.1.46 Minimum Power (00.0 to 99.9%)**

This parameter sets the minimum power level for the minimum power warnings. If the power is at or below this level during a deposit a Minimum Power attention warning will be given. If this condition remains true for longer than the time set by the Power Alarm Delay parameter then a Minimum Power Alert warning will be given.

#### **5.3.1.47 Rate Dev. Attention (00.0 to 99.9%)**

The rate deviation attention parameter sets the allowable percent deviation from the deposition rate. If the deposition rate deviates by more than this percentage during the deposition, then a rate deviation attention message will be displayed in the Parameter/Status display. The default setting of 00.0% disables this function.

#### **5.3.1.48 Rate Dev. Alarm (00.0 to 99.9%)**

This parameter sets the percent deviation from the deposition rate required to trigger a rate deviation alarm. The default setting of 00.0% disables this function.

#### **5.3.1.49 Rate Dev. Abort (00.0 to 99.9%)**

The rate deviation abort parameter sets the allowable percent deviation from the deposition rate. If the deposition rate deviates by more than this percentage and the deposit power is at the maximum or minimum power alert level then the process will be aborted. The default setting of 00.0% disables this function.

#### **5.3.1.50 Sample Dwell% (000.0 to 100.0)**

The Sample Dwell% parameter establishes the percentage of the Sample Time for which the crystal is being sampled. Rate sampling is used for high deposition thickness where crystal life is a problem. By sampling the rate periodically and setting the power level to establish rate control, then closing the crystal shutter and maintaining the power level, a large deposition thickness can be achieved with one crystal. The primary sensor must have an individual shutter for the rate sample feature. The default for this parameter is 100% which enables sampling at all times.

#### **5.3.1.51 Sample Period (0 to 9:59:59)**

The Sample Period parameter defines the sample period. For example, a sample time of 5 minutes and a dwell of 40% will result in the crystal being sampled for 2 minutes, then the crystal shutter is automatically closed for the remaining 3 minutes while the deposition power is kept constant. Please note, once the crystal shutter has opened, there is a 5-second delay for crystal stabilization before measuring.

#### **5.3.1.52 Crystal Marginal % (0-99)**

This parameter defines percent that causes the Crystal Marginal event. Default is 82%.

#### **5.3.1.53 Crystal Fail (Halt, Time Pwr, Switch, SwitchTimePwr)**

This parameter defines the controller's action in the event of a crystal failure. The options are:

1. To halt the process
2. Finish the current layer on time-power
3. Switch to a backup crystal, halt if second crystal fails
4. Switch to a backup crystal, finish the current layer on time-power if second crystal fails

Time power will only work if the 861 is in states Deposit 1,2,3,4, or 5 and average rate is between 50% and 150% of the target rate. Note when the 861 is in time-power it will be unable to execute any further rate ramps.

**5.3.1.54 Backup Sensor (1 to 4)**

This parameter defines the backup sensor input for the backup crystal. For a dual sensor head, this parameter is set to 2 assuming sensor #1 is the primary crystal. However, for six crystal sensor head, this parameter would be the same value as the Sensor# parameter and the Backup Crystal # parameter below would be set to two. This is because the six crystal sensor head uses one sensor input to measure any of its six crystals while the dual sensor head uses two sensor inputs to measure either crystal.

**5.3.1.55 Backup Tooling Factor % (10.0 to 499.9%)**

This parameter defines the tooling factor for the backup sensor head

**5.3.1.56 Backup Crystal (1 to 8)**

This parameter defines the backup crystal number.

**5.3.1.57 Crystal Switch Settling (sec) (0 to 240)**

This parameter defines the time after a crystal switch the PID is disabled and the power setting is continues at the same setting it was before the switch for the time indicated. Default is 0.

## 5.4 PROCESS

Selecting View/Edit Process from the Main Menu will present the Select Process screen to delete, copy, view or edit any one of up to 99 processes. Press on a process and the option menu will pop up. Then select option.

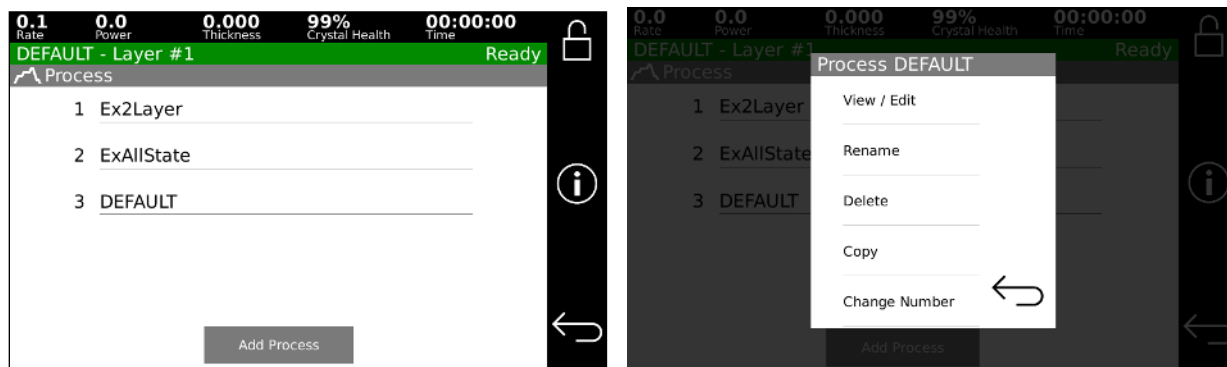

Figure 5-21, Select Process screen

### 5.4.1 Define A Process

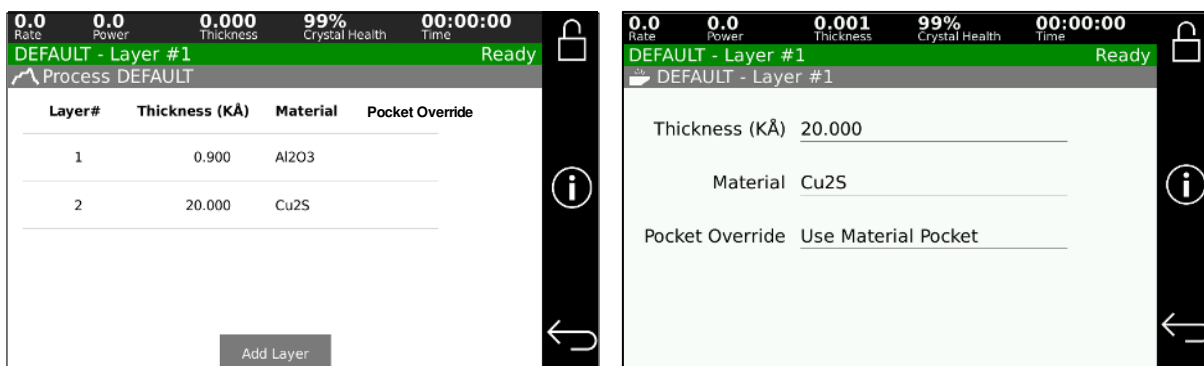

Figure 5-22, Define Process screen

Selecting a process will bring up the Define Process screen as shown in figure 5-22. In this screen, enter all of the layers that define a process. Each layer consists of a material and the desired thickness for the layer. A process can have from 1 to 999 layers as long as the total number of layers in all the processes is not greater than 999. The following list describes all of the process parameters:

#### 3. Process Name (twelve character alphanumeric field)

Each process is referenced by a twelve-character alphanumeric process name. You enter a process name using the on screen keyboard. Please note that the active process name is displayed in the upper left-hand corner of all the status screens.

##### 5.4.1.1 Layer (1 to 999)

This column shows the layer number in the process. With the menu for a layer number you can copy or delete this layer.

##### 5.4.1.2 Thickness (000.0 to 999.9)

This parameter defines the desired thickness for the layer. The default for this parameter is 0.000 K ang.

##### 5.4.1.3 Material

This parameter defines the material for this layer. The layer material is selected from the list of materials defined in View/Edit material. Therefore, you should define all of the necessary materials for the process before defining the process.

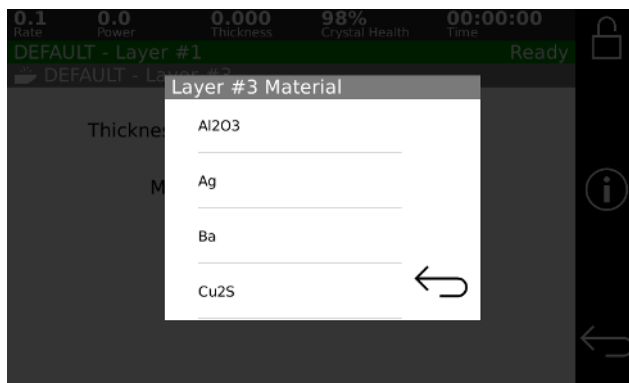

Figure 5-23, Select Layer Material screen

#### 5.4.1.4 Pocket Override

The pocket override lets you override the pocket number that is set in the material. This value can be set from 0 to 30. If set to 0 then there is no override and the pocket number set in the material will be used. Pocket override is useful for processes that require a new pocket of material for each layer, but all the same material settings.

## 6 OPERATION

### 6.1 INITIAL POWER UP

Upon initial power up the unit screen will be white for 10 seconds, then black for 20 seconds, then display a splash screen for approximately 1 minute. The display will then show the controller configuration information. The unit will stay in this state until anywhere on the touch screen is pressed then the unit will go to the main screen.



**Figure 6-1, Splash Screen**



**Figure 6-2, 861 Configuration Screen**



## 6.2 DISPLAYS

All of the operating displays are updated several times per second.

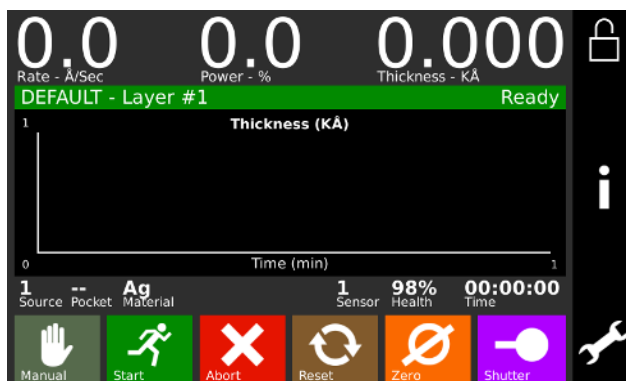

Figure 6-3, Operating Display

### 6.2.1 Rate



Green numbers indicating the target rate are displayed during deposition.

A two to three digit display with a floating decimal point is used to display deposition rate in angstroms per second at a resolution of 0.1 Å/sec from 0 to 99.9 Å/sec, and a resolution of 1.0 Å/sec for rates from 100 to 999 Å/sec.

### 6.2.2 Power

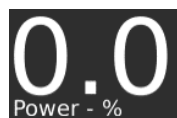

A two to three digit display with a fixed decimal point displays percent of maximum power with a resolution of 0.1% from 0 to 99.9%. This corresponds to the control voltage range of 0 to 9.99 volts.

### 6.2.3 Thickness



Green numbers indicating the target thickness are displayed during the layer.

Four digits with an autoranging decimal point display measured thickness in KÅ with a resolution of 1 Å from 0 to 9.999 KÅ, a resolution of 10 Å from 10.00 KÅ to 99.99 KÅ and a resolution of 100 Å from 100.0 KÅ to 999.9 KÅ.

### 6.2.4 PROCESS NAME and LAYER NUMBER



When running a process the name of the current process is displayed on the left of the status bar. Note the status bar will be purple in similar mode.



The current layer of the current process is displayed next to the process name on the status bar.

### 6.2.5 Film Number



When running a film the film number will show on the left of the status bar.

### 6.2.6 System Status



The current 861 system status is displayed on the right of the status bar.

### 6.2.7 Source Number



The current source number is displayed.

### 6.2.8 Pocket Number

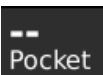

The current pocket number is displayed if the 861 has selected one.

### 6.2.9 Material Name



The current material is displayed.

### 6.2.10 Sensor Number



The current sensor number is displayed.

### 6.2.11 Crystal Health %

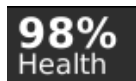

A two digit display is used to show the health percentage of the sensor crystal in use. A fresh crystal starts out with a health of 99%. If no crystal is attached, this will show "--".

### 6.2.12 Time To Go

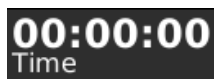

Time To Go is displayed in hours, minutes and seconds. This display can be configured to show the estimated state or layer time or the elapsed process, layer or state times.

## 6.3 OPERATING CONTROLS

---

Normal operation of the 861 is controlled by seven operating buttons, Manual, Start, Abort, Reset, Zero, Shutter and Status.

### 6.3.1 Manual Button



This button is used to toggle the 861 Manual mode on and off. **When the button is surrounded by a flashing white box it indicates that the controller is in manual power control mode.** This mode may be selected at any time providing that the controller is not in Abort mode. The Manual mode indicates that the source control voltage output is being controlled through the Remote Power Handset. In the Manual mode the control voltage remains constant unless incremented up or down by means of the Remote Power Handset. At entry into the Manual mode, the power is left at the last value prior to entry and is thereafter modified only through the Remote Power Handset. Exit from the manual mode is accomplished by means of the Manual or Reset button.

The 861 can also be aborted through the Remote Power Handset. This abort feature is active whether or not 861 is in the manual mode.

### 6.3.2 Start Button

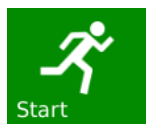

The Start button starts a process, starts a layer, resumes an aborted process, or notifies the 861 that the pocket or crystal is in position. **When the button is surrounded by a white box it indicates the controller is in process.** When this button is pressed the first time either "Start" or Select process" can be chosen. "Start" will start the process and "Select process" will bring up a list of stored processes to choose from.

### 6.3.3 Abort Button



The Abort button puts the 861 into the Abort mode. All source powers are set to zero and discrete outputs are set to false state except the Abort output. A white outline around this button indicates the controller is in the abort mode and the status bar color changes to red and displays the ABORT status.

### 6.3.4 Reset Button



The Reset button is used to clear the controller from Abort mode and put it into the Ready mode, in which a process can be started. The Reset button is inactive during the In Process mode so that a premature exit from the In Process mode requires an abort.

### 6.3.5 Zero Button



Pressing the Zero button causes the thickness display to go to zero. This button is active at all times and if pressed during the deposit state will result in a film thicker than that programmed amount equal to the thickness displayed at the time the display was zeroed.

### 6.3.6 Shutter Button

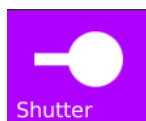

This button is used to manually open and close all source shutters. **A white outline around this button indicates that the active source shutter relay is closed** (if any shutter is configured). When the controller is in the Process Ready mode, this button may be selected to open or close the shutter.

## 6.4 SIDE BAR CONTROLS

---

### 6.4.1 Status Button



This button is used to cycle through the different status screens. The display settings

allow the six different status screens to be active or not. Refer to chapter 6 for a detailed description of these status screens.

### 6.4.2 Program Button



Pressing the programming button will bring up the main programming screen.

## 6.5 MANUAL POWER HANDHELD

---



**Figure 6-4, Manual Power Handheld**

Manual Mode is selected by depressing the Manual button on the touchscreen. The button will be surrounded by a white blinking line that indicates the controller is in Manual mode.

The Manual Mode is identical to the normal mode in all respects except that source power is controlled only through the Manual Control Handheld, see figure 6-4.

Pressing the Up button will increase the power.

Pressing the Down button will decrease the power.

Pressing the “ABORT” button will put the controller into the Abort mode.

The Abort Mode is active whether or not the 861 is in Manual Mode and therefore can be used as a remote “panic button”.

The minimum increment by which the power is increased or decreased is 0.1%.

## 6.6 SIMULATE OPERATION

---

Testing the 861 is best accomplished by checking its operation in the Simulate mode. This mode can be selected by using the programming Main Menu, Edit System Setup, Edit Utility Setup, to select Simulate mode ON, then use Start to select and run a process in Simulate mode.

The Simulate mode is identical to the Normal mode except that the sensor input is simulated.

## 6.7 STARTING A PROCESS

---

Pressing the Start button while the controller is in the Ready state will present the menu shown below. From this menu you can:

**Start** –Starts the current process select a starting layer

**Start from Layer** – Starts from input layer number of the current process

**Select Process** – Selects a different process

**Select Film** – Selects a film to run (a one-layer film that uses the material thickness value)

**Change Run Number** – Changes the run number to in run number

The Run number is displayed on the top bar

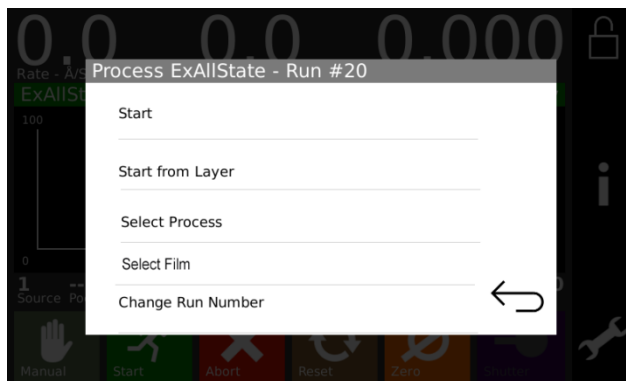

Figure 6-5, Run Selection Screen

## 6.8 STARTING A NEW LAYER

---

The Start button is also used to start individual layers when the controller is set up for manual layer sequencing. The controller will prompt the operator to press the Start button to start the next layer.

## 6.9 RESUMING AN ABORTED OR HALTED PROCESS

---

Press Start to resume the process or Reset to cancel.

The Start button is also used to resume an aborted or halted process. Note that Start button is green and has a white box around it then the process can be resumed. Otherwise, the controller has to be reset, and the process has to be started over.

Follow the prompt to resume the process.

## 6.10 STATUS DISPLAYS

There are six different run time status screens that can be displayed at any time by pressing the Status button (providing they have each been enabled using Edit Display Setup). Repeatedly pressing the Status button will cycle through the six status screens, shown below.

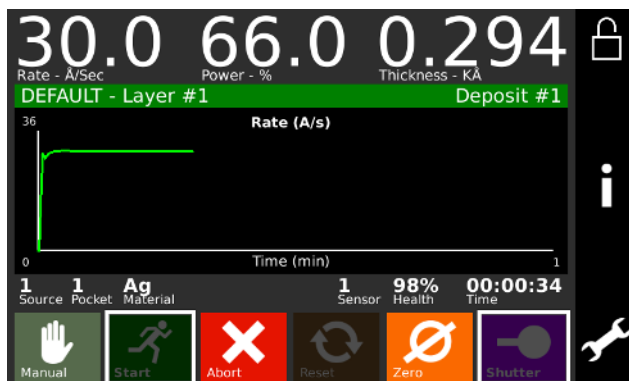

Figure 6-6, Rate vs. Time Graph

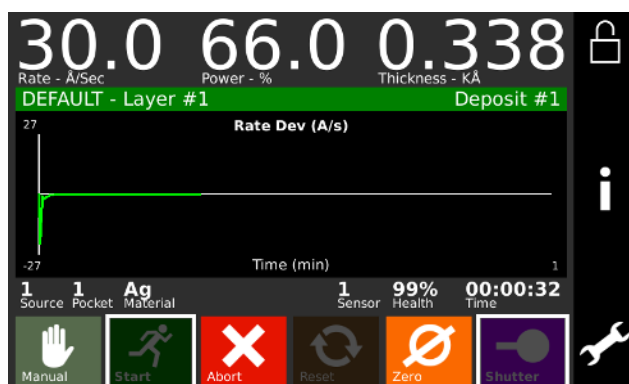

Figure 6-7, Rate Deviation vs. Time graph



Figure 6-8, Thickness vs. Time Graph

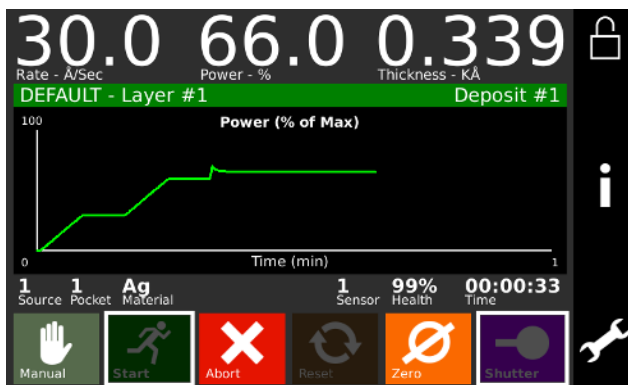

Figure 6-9, Power vs. Time Graph

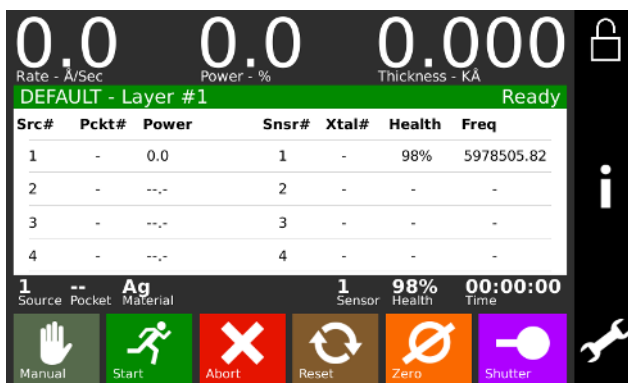

Figure 6-10, Source/Sensor Status screen

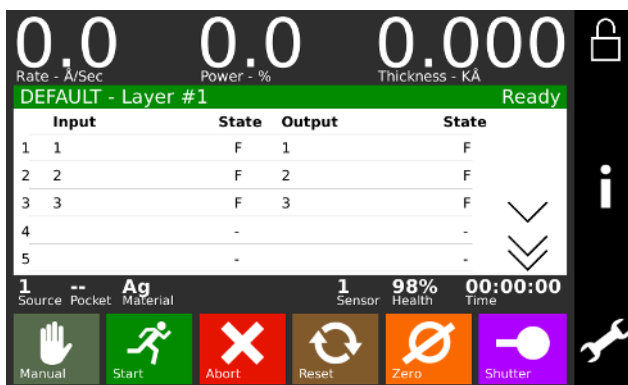

Figure 6-11, I/O Status Screen

## 6.11 MODES

Modes are conditions which the controller can occupy. Some modes are indicated by white boxes around the operating buttons. Other modes are displayed in the top right hand corner of the status display. These controller modes are described below.

### 6.11.1 Ready

The Process Ready Mode indicates the 861 has been reset and is awaiting a Start button press.



### **6.11.2 Abort**

The Abort mode is indicated by “Abort” and a red status bar. In Abort Mode all displays and operating buttons, with the exception of the Start and Reset buttons, are inoperative. All source control outputs are forced to zero, the Abort relay is closed and all discrete outputs are forced to open circuit. In addition, if the controller initiated the abort then the condition which caused the abort will be displayed in the top right hand corner of the Parameter/Status display. Exit from Abort Mode requires either a Reset or Start button press.

### **6.11.3 In Process**

A white box around the Start button is displayed when the controller is in the In-Process Mode.

### **6.11.4 Not Sampling**

This mode indicates that the sensor crystal is shuttered from the source and that the deposition rate is established using the last power level. Sampling mode is set by two material parameters, Sample Dwell % and Sample Period.

### **6.11.5 Process Complete**

This mode indicates that the selected process has run to completion. A Process Complete message is displayed in the top right hand corner of the status display. In addition, an attention warning will sound. The controller remains in this mode until a reset signal puts it into the Process Ready mode.

### **6.11.6 Manual**

This mode is indicated by a White flashing box around the Manual button. In this mode the control voltage output is controlled through the Remote Power Handset.

### **6.11.7 Simulate**

This mode simulates rate and thickness build-up by simulating the sensor input rather than the actual sensor.

## **6.12 STATES**

---

Figure 6-12 shows the different states that make up a complete deposition cycle, such as Rise to Soak, Rise to Predeposit, etc. The controller moves from state to state as the deposition progresses.

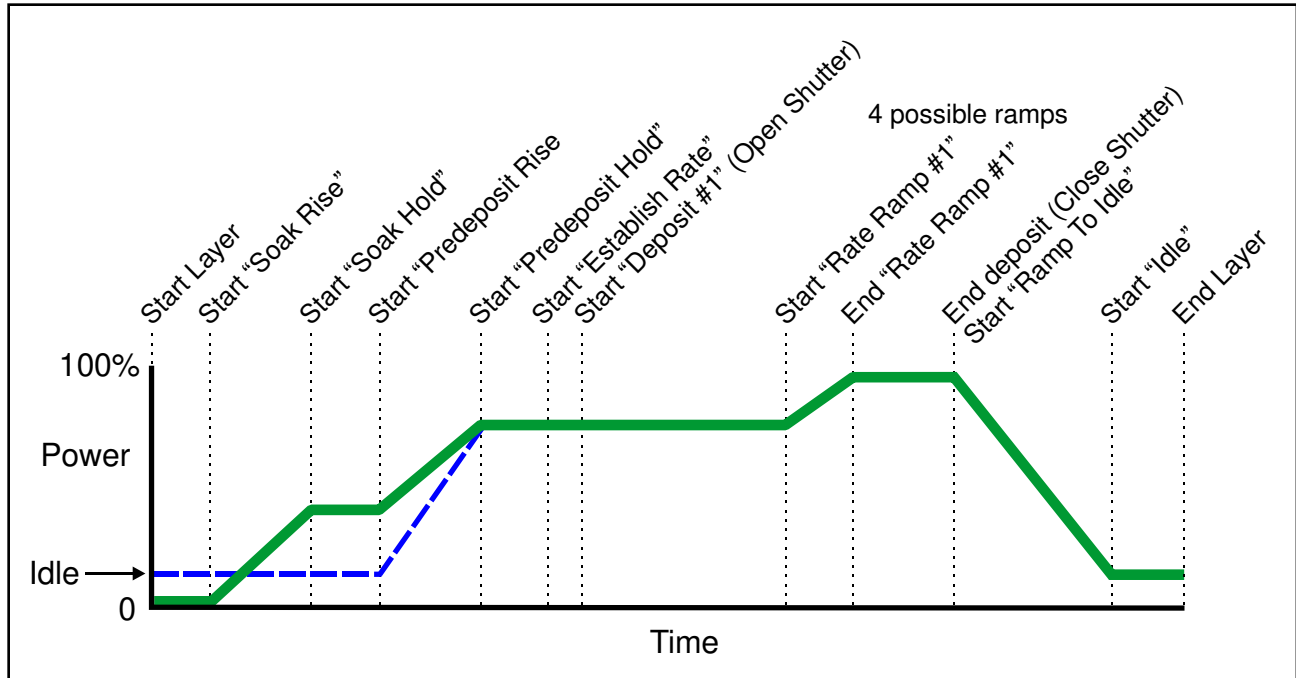

Figure 6-12, Typical Process Profile

## 6.13 ERROR, WARNING, AND INFORMATION MESSAGES

These messages are displayed in the top right-hand corner of the status screen.

In addition, there are three levels of audible warnings associated with the trouble conditions, Attention, Alert and Alarm. An asterisk in the Clear column indicates the warning sound will clear when the condition clears.

Touching the screen will also clear the sound.

Table lists the messages and warning levels. The list is arranged in descending order of priority. In the event that more than one warning level is triggered, the higher level has priority. The action column indicates what if any action is taken as a result of the trouble.

Messages	Warning		
	Type	Clear	Action
Min Rate&Max Power	Alarm		Abort
Max Rate&Min Power	Alarm		Abort
System Setup memory corrupted	Alarm		Halt
Process memory corrupted	Alarm		Halt
Material memory corrupted	Alarm		Halt
Rate Est. Error	Alarm		Halt
Crystal Failure	Alarm/Attn	NO/*	Halt
Source Fault	Alarm		Halt
Sensor Fault	Alarm		Halt
Time Power	Alarm		Time/Power
Rate Dev. Alarm	Alarm	*	
Alarm Action	Alarm		

Crystal Marginal	Alert/Attn	NO/*	
Rate Dev. Alert	Alert	*	
Max power Alert	Alert	*	
Min power Alert	Alert	*	
Alert Action	Alert	*	
Xtal Fail Switch	Attention		Crystal Switch
Xtal Mrgn Switch	Attention		Crystal Switch
Rate Dev. Atten	Attention	*	
Max power	Attention	*	
Min power	Attention	*	
Change source # X to (material name) and press Start to continue.	Attention		Hold
Change sensor # X to crystal # X and press Start to continue.	Attention		Hold
Attention Action	Attention	*	
Press Start to resume process.	N/A		
Start to continue.	Attention	*	Hold

An asterisk in the Clear column indicates the warning sound will clear when the condition clears.

Touching the screen will also clear the sound.

**Table 6-1, Error, Warning, and Information Messages**

**6.13.1 Description**

Each of the messages is described below.

**6.13.2 Min Rate & Max Power**

This message indicates that the output power is at the maximum power level set by the Maximum Power parameter and the rate deviation is below the limit value set in the Rate Dev. Alarm parameter. When this happens, the controller will go into the Abort mode and the Alarm will sound.

**6.13.3 Max Rate & Min Power**

This message indicates that the output power is at the minimum power level set by the Minimum Power parameter, and the rate deviation is above the limit value set by the Rate Dev. Abort parameter. When this happens, the controller will go in Abort mode and the Alarm warning will sound.

**6.13.4 Rate Est. Error**

The controller is unable to establish the programmed rate within the time specified in the Rate Establish Time parameter. The rate is considered established when it stays within the Rate Establish Error % for 5 seconds.

**6.13.5 Crystal Failure**

This condition indicates lack of a valid signal from the sensor, and generally results from a failed crystal but may also indicate problems in the crystal mounting or the interconnection between the sensor and the controller. If the primary crystal fails and the process is not in deposit state, the Attention warning will sound. If the backup crystal

fails and the process is not in the deposit state, the alarm will sound and the process will be halted.

### **6.13.6 Time Power**

This message is displayed when the controller is completing the current layer based on the last power and rate. This occurs in the event of a crystal failure without a backup.

### **6.13.7 Rate Dev. Alarm**

The deposition rate error is greater than the rate deviation value set in the Rate Deviation Alarm parameter.

### **6.13.8 Alarm Action**

This message indicates the Alarm sound was initiated by an internal action.

### **6.13.9 Crystal Marginal**

The sensor crystal in use has exceeded the allowable crystal marginal setting. If the crystal is the backup one, the Alert warning will sound when the process is in deposit state. If the primary crystal is in poor quality then the Attention will sound. The percent that causes a crystal to be marginal is set in the material settings, default is 82%.

### **6.13.10 Rate Dev. Alert**

The deposition rate deviation is greater than the value set in the Rate Deviation Alert parameter.

### **6.13.11 Max Power Alert**

Indicates that the power output level has been at the Maximum Power level longer than the time period set in the Power Alert Delay parameter.

### **6.13.12 Min Power Alert**

Indicates that the power output level has been at or below the Minimum Power level longer than the time period set in the Power Alert Delay parameter.

### **6.13.13 Alert Action**

This message indicates the Alert sound was initiated by an internal action.

### **6.13.14 Xtal Fail Switch**

This message indicates the primary crystal has failed and the sensor input has been switched to the backup crystal. In addition, the Attention warning sounds. Press any button to clear the sound.

### **6.13.15 Xtal Mrgn Switch**

This message indicates the primary crystal is marginal and the sensor input has been switched to the backup crystal. In addition, the Attention warning sounds. Press any button to clear the sound.

### **6.13.16 Rate Dev. Atten**

The deposition rate deviation error is greater than the value set in the Rate Deviation Attention parameter.

### **6.13.17 Maximum Power**

The output power is being limited by the value set in the Maximum Power parameter.

### **6.13.18 Minimum Power**

The output power is at or below the minimum power set by the Minimum Power parameter.

### **6.13.19 Change Pocket**

Prompts the operator to switch the source pocket to the correct position. The process will be on hold until the Start button is pressed. There is no message if the Control parameter is set to Auto (Source Setup Menu).

### **6.13.20 Change Crystal**

Prompts the operator to switch the sensor to the correct crystal position. The process will be on hold until the Start button is pressed. There is no message if the Control parameter is set to Auto (Sensor Setup Menu).

### **6.13.21 Attention Action**

This message indicates the attention sound was initiated by an internal action.

## 7 TUNING

### 7.1 ESTABLISHING 861 CONTROL LOOP PARAMETERS

As explained above, the 861 utilizes three control loop parameters referred to as PID parameters; Proportional gain, Integral Time constant and Derivative Time constant to provide for optimization of the control loop. The 861 provides default values for each of these parameters.

#### Default and Range for PID Parameters

Parameter	Minimum value	Maximum value	Default value
Proportional gain	1	9999	600
Integral time constant, sec.	0	99.9	99.9
Derivative time constant sec.	0	99.9	0.0

The following table lists some recommended PID values for different types of deposition sources. These values represent a good starting point and in some cases may not need to be further modified.

#### Suggested PID Starting Values for Different Sources

Parameter	Electron Beam Gun	Filament Boat
Proportional gain	600	600
Integral time constant, sec.	99.9	99.9
Derivative time constant sec.	0.0	75.0

In the 861, the PID parameters are defined at the material level because different materials often require different PID settings even though they may be deposited from the same source. Therefore it is usually necessary to establish the PID parameters for every each material and deposition source.

The first step in setting the PID parameters for a new material or source is to enter the recommended starting values listed above. Be sure and choose the PID values for the type of source you're using. Next, create a dummy process with the first layer set for the new material. Start and abort the dummy process to load the new material as the active material. You should now see the material's name in the top line of any Status Screen.

Next, open the shutter and put the 861 in the manual power mode and adjust the source power using the remote handset to establish the power ramp parameters. Set the Predeposit Power level at or slightly below the power needed to get the desired deposition rate.

With the power ramp parameters defined, the next step is to start the dummy process to see how well the 861 controls the rate. If the rate is too high or low when the shutter opens then make a note to go back and adjust the Predeposit Power level. Watch the rate graph and the power display. If the rate is different from the target rate then you should see the 861 adjust the power attempting to achieve the target rate. If the rate is close to the target, then you should temporarily change the rate to see how the 861 reacts. Ideally the 861 will adjust the power so that the rate goes right to the target rate without overshooting it. If it does then no further adjustments are necessary.

If it seems like the 861 is reacting too slowly, press the Program button to get back to the material screen and increase the Proportional Gain parameter. Begin with changes of about 10 to 20%. Changes of this magnitude are a good starting point because they are large enough to show the effect of the parameter and small enough that you won't greatly overshoot the ideal setting. Remember that too much Proportional Gain will make the system unstable and too little will make the 861 slow to react. An unstable system is evident by the rate oscillating around the target value. A general rule of thumb is the faster the source, the larger the Proportional Gain. And conversely, the slower the source the smaller the Proportional Gain.

With the Proportional Gain at an acceptable value, the next step is to adjust the Derivative Time if necessary. Disturb the system again by changing the target rate. Watch the rate graph as the rate approaches the target. If the rate overshoots the target then increase the Derivative Time and change the target rate again to see the effect. Repeat these steps slowly increasing the Derivative Time until the rate goes right to the target without overshoot.

In very slow systems such as large filament boats, the Proportional Gain parameter may have to be set so low to maintain stability where the rate smoothly levels off but remains below the target value. In this case you will need to adjust the Integral Time parameter. This parameter works in reverse meaning the smaller the value the larger the effect. So, slightly decrease this parameter then watch the rate graph. The rate should ramp up to the target without overshoot. If the ramp takes too long then slowly decrease the Integral Time again and repeat these steps until you are satisfied with the control.

## 7.2 EMPIRICAL CALIBRATION

---

For many film materials the film density and acoustic impedance is known to sufficient accuracy that the values can be used directly, and empirical calibration of these parameters is not necessary. A library of material names, density and acoustic impedance of the more commonly deposited materials is stored in the 861 memory. These materials are also listed in supplied pdf.

If the values of the density and acoustic impedance are not known they can be calibrated empirically as described below.

Calibration requires the establishment of the film density, the tooling factor and the acoustic impedance in this order. If the approximate value of the parameters is known they should be used initially. If the acoustic impedance is not known use the value 8.83, the value for quartz.

### 7.2.1 Film Density

Establishing the film density can be accomplished by depositing a trial film on several test substrates placed around and as close as possible to the sensor crystal and in the same plane. The trial deposition should be thick enough to allow an independent measurement of the film on the test substrates to be made with adequate precision using an optical interferometer or surface measuring device.

When making the trial deposition, use a fresh crystal and remember to write down the final thickness reading displayed by the 861, as this will be needed in the calculation. If the acoustic impedance parameter has been accurately established previously, a fresh crystal is not required.

Determine the average film thickness on the test substrates and use the following equation to calculate the material's density:

$$\text{Density} = (\text{Displayed Thickness}/\text{Average Measured Thickness}) * \text{Density}(\text{test})$$

Where Density(test) is the density parameter setting used during the calibration run.

Once the calibration procedure is complete, the programmed film density is correct for this particular film.

### 7.2.2 Tooling Factor

Having established the film density the tooling factor should be established. Place several test substrates at representative locations in the deposition fixture. Again deposit a trial film as above using the known film density, and a fresh crystal unless the programmed acoustic impedance is known to be correct. Remember to write down the final thickness reading displayed by the 861, as this will be needed in the calculation. Determine the average film thickness on the test substrates. If the average measured thickness differs from the displayed thickness, use the following equation to calculate the correct tooling factor.

$$\text{Tooling} = (\text{Average Measured Thickness}/\text{Displayed Thickness}) * \text{Tooling}(\text{test})$$

Where Tooling(test) is the tooling parameter setting used during the calibration run.

### 7.2.3 Acoustic Impedance

Establishment of the acoustic impedance requires that the crystal be heavily loaded. Continue to deposit on the sensor crystal until the crystal health approaches 50% or until the crystal is approaching the end of its useful life. Deposit another trial run as above but this time use the manual power mode instead of the automatic mode. Measure the average film thickness on the test substrates and then adjust the acoustic impedance parameter up or down to bring the displayed thickness into agreement with the measured thickness. This calibrates the acoustic impedance parameter.



The 861 is now fully calibrated for the film in question and should produce consistent and accurate films.

## 8 THEORY OF OPERATION

---

### 8.1 BASIC MEASUREMENT

---

The 861 uses a quartz crystal as the basic transducing element. The quartz crystal itself is a flat circular plate approximately 0.55 in. (1.40 cm) in diameter and 0.011-0.013 in. (28-33mm) thick for 6 and 5 MHz. The crystal thickness is inversely proportional to the crystal frequency. The crystal is excited into mechanical motion by means of an external oscillator. The unloaded crystal vibrates in the thickness shear mode at approximately the frequency of the specified crystal. The frequency at which the quartz crystal oscillates is lowered by the addition of material to its surface.

### 8.2 CRYSTAL HEALTH CALCULATION

---

Crystal Health decreases from a value of 100% for an uncoated crystal blank to 0 at a total deposited aerial mass of 25 mg/cm<sup>2</sup>. This value corresponds to a crystal frequency shift of approximately 1.5 MHz, or an aluminum thickness of 925 Å.

Very few materials can be deposited to this thickness without producing a crystal failure, so that a crystal health of zero will not normally be achieved and indeed for some materials the crystal health may never get below 90%.

In order to establish the point at which the crystal should be changed, several trial runs should be made to determine the point at which the crystal fails and subsequent crystals should then be replaced well in advance of this point.

Because the crystal health is determined from the calculated film mass, the Acoustic Impedance parameter will affect the displayed crystal health.

### 8.3 RATE CALCULATION

---

The deposition rate is calculated by dividing the change in thickness between measurements by the time between measurements. The rate is then filtered by a three-pole digital filter to filter out quantizing and sampling noise introduced by the discrete

time, digital nature of the measurement process. The above filter has an effective time constant of about 2 seconds. Following a step the displayed rate will settle to 95% of the final value in 5 sec.

## 8.4 RATE CONTROL

---

Deposition rate control is achieved in the 861 by comparing the measured thickness rate with the desired thickness rate. The rate error and the rate of change of rate error are then used to determine how much to increment the power up or down.

The amount the power is incremented is also affected by the response parameter. The response parameter is divided by 50, squared and then used as a multiplier in the determination of delta power.

The rate error is divided by the programmed rate and multiplied by 100 to obtain the displayed percent rate error.

## 8.5 EMPIRICAL CALIBRATION

---

For many film materials the film density and acoustic impedance is known to sufficient accuracy that the values can be used directly, and empirical calibration of these parameters is not necessary. A library of material names, density and acoustic impedance of the more commonly deposited materials is stored in the 861 memory. These materials are also listed in Table 9.1.

If the values of the density and acoustic impedance are not known they can be calibrated empirically as described below.

Calibration requires the establishment of the film density, the tooling factor and the acoustic impedance in this order. If the approximate value of the parameters is known they should be used initially. If the acoustic impedance is not known use the value 8.83, the value for quartz.

### 8.5.1 Film Density

Establishing the film density can be accomplished by depositing a trial film on several test substrates placed around and as close as possible to the sensor crystal and in the same plane. The trial deposition should be thick enough to allow an independent measurement of the film on the test substrates to be made with adequate precision using an optical interferometer or surface measuring device.

When making the trial deposition, use a fresh crystal and remember to write down the final thickness reading displayed by the 861, as this will be needed in the calculation. If the acoustic impedance parameter has been accurately established previously, a fresh crystal is not required.

Determine the average film thickness on the test substrates and use the following equation to calculate the material's density:

$$\text{Density} = (\text{Displayed Thickness}/\text{Average Measured Thickness}) * \text{Density}(\text{test})$$

Where Density(test) is the density parameter setting used during the calibration run.

Once the calibration procedure is complete, the programmed film density is correct for this particular film.

### **8.5.2 Tooling Factor**

Having established the film density, the tooling factor should be established. Place several test substrates at representative locations in the deposition fixture. Again, deposit a trial film as above using the known film density, and a fresh crystal unless the programmed acoustic impedance is known to be correct. Remember to write down the final thickness reading displayed by the 861, as this will be needed in the calculation. Determine the average film thickness on the test substrates. If the average measured thickness differs from the displayed thickness, use the following equation to calculate the correct tooling factor.

$$\text{Tooling} = (\text{Average Measured Thickness/Displayed Thickness}) * \text{Tooling}(\text{test})$$

Where Tooling(test) is the tooling parameter setting used during the calibration run.

### **8.5.3 Acoustic Impedance**

Establishment of the acoustic impedance requires that the crystal be heavily loaded. Continue to deposit on the sensor crystal until the crystal health approaches 50% or until the crystal is approaching the end of its useful life. Deposit another trial run as above but this time use the manual power mode instead of the automatic mode. Measure the average film thickness on the test substrates and this adjust the acoustic impedance parameter up or down to bring the displayed thickness into agreement with the measured thickness. This calibrates the acoustic impedance parameter.

## 9 STANDARD INTERFACE

---

### 9.1 GENERAL

---

The 861 comes standard with both RS-232 serial and Ethernet interface. The computer interface of the Telemark 861 Deposition Controllers permits remote control using a personal computer or process controller. The protocol is changed in the Utility menu under Serial Protocol.

There are four types of protocols: Standard, 360C, ASCII Checksum and ASCII No Checksum. This chapter deals with the standard protocol.

### 9.2 RS-232 SERIAL INTERFACE

---

The standard RS-232 serial interface of the 861 allows one 861 to be connected to any other device with a RS-232 serial interface. A D9P connector is provided on the rear panel for permanent connection to the host computer. See figure 3-5.

The 861 acts as DTE, and, accordingly, the 9-pin connector has 'plug' pins. It can be used with a DCE or a DTE host cable connection providing the sense of the RxD/TxD data lines and the control lines is observed. Pin 2 'TxD' transmits data from the 861 to the host; pin 3 'RxD' receives data from the host. Pin 7 'CTS' is a control output signal from the 861, and pin 8 'RTS' is a control input signal.

In this implementation, pin 7 'CTS' means what it says, namely, this is an output control line, and when the 861 asserts this control line 'true' the host can transmit to the 861. On the other hand, pin 8 'RTS' is not quite what it may seem because this is a signal input to the 861, and it is intended that the host should assert this line 'true' only when the 861 is allowed to transmit data to the host. The 861 does not generate an RTS 'request-to-send' as such for the host PC, so the host should assert pin 8 true whenever the 861 is allowed to transmit to the host, without being asked to do so.

The 861's RS-232 port is automatically set up to operate with the following specifications:

8 Bit data, No Parity, 1 Stop bit

In the utility menu the baud rate is selectable 9600, 19200, 38400, 57600, or 115200. The 861 will process a maximum of 20 RS-232 input messages a second.

### 9.3 ETHERNET INTERFACE

The Standard Protocol is the only protocol on the 861 that can be used on the ethernet port. It can be run at the same time as the serial interface.

The Ethernet interface allows the 861 to be connected to any number of other devices with a TCP/IP Ethernet connection. The 861 Ethernet IP number can be static or assigned by a DHCP server. If using static IP number on a companywide network, contact your IT department for a number to use so there is no chance of two devices having the same address. Computer Interface port is 4242. When remotely connecting to an 861 the port is usually added at the end of the IP address (example 10.10.1.126:4242).

The subnet mask is used by the TCP/IP protocol to determine whether a host is on the local subnet or on a remote network. The default is 255.255.255.0

### 9.4 PROTOCOL

All communications between the computer and the 861 are in bytes.

Example: To initiate a zero thickness instruction the computer would send the following bytes shown below. Different formats are shown that are used in different programming environments.

	Header	Interface Address	Instruction	Length	Message	Checksum
<b>Decimal Bytes</b>	255 254	001	000	001	008	246
<b>Character String</b>	Chr\$(255) Chr\$(254)	Chr\$(1)	Chr\$(0)	Chr\$(1)	Chr\$(8)	Chr\$(246)
<b>Siemens IPC</b>	ÿ þ	\$01	\$00	\$01	\$08	ö
<b>Hex</b>	FF FE	01	00	01	08	DE

**Header** - Two byte header – FF FE i.e. decimal bytes 255 254

**Interface Address** - One byte controller address - The controller address byte defines the controller that should receive the message, or should respond to the message by transmitting data. The controller address will range from 0 to 32 (set via Edit System Setup, Edit Utility Setup, Interface Address).

**Instruction** - One byte instruction code.

**Length** - One byte message length.

**Message** - 0-249 byte message.

**Checksum** - One byte checksum, for the instruction code byte, message length byte and the 0-249 byte message.

The checksum is the two's complement of the one byte sum of all bytes from, and including, the instruction code to the end of the message. If the one byte sum of all these bytes is added to the checksum, the result should equal 255.

A single byte checksum can be generated using the calculation:

$$\text{checksum} = \text{!(sum of all but the header bytes \% 256) + 1,}$$

i.e. the checksum is the bit inversion of the remainder byte which results from dividing the sum of all bytes by 256.

In Excel the check some can be calculated by:

$$=(255-\text{MOD}(\text{SUM}(\text{all but the header bytes}),256))+1$$

## 9.5 DATA TYPES

---

There are three data types sent over RS-232: one byte, two byte, and three byte parameters. All data types are sent as integers in binary format with the most significant byte first. The one byte data types are either ASCII characters, numeric values (0-255), or 8 bit registers. Some of the multiple byte data types are decimal values stored as integers. To convert these values to their decimal equivalent, use the following equation:

$$\text{Decimal value} = (\text{Integer value}) / (10^{\text{DP}})$$

where DP is the value's decimal point position. The decimal point positions for all the parameters are constant and are given in tables along with the parameters' range.

## 9.6 MESSAGE RECEIVED STATUS

---

Following the receipt of each message, the controller will send a one-byte 'received status' message, indicating how the message was received, with the following format:

**Format:**

Header - Two byte header – FF FE i.e. decimal bytes 255 254

Interface Address One byte controller address

Instruction Code = 253

Length = 2

Instruction Code of the received message

Receive code, see table below

Checksum

A value of 253 for the instruction byte indicates that this is a received status message. The Instruction Code byte indicates the instruction code of the message that was received. The following table shows a list of possible receive codes:

Receive Code	Description
0	Message received O.K.
1	Invalid checksum.
2	Invalid instruction code.
3	Invalid message length.
4	Parameter(s) out of range.
5	Invalid message.
6	Process undefined. Can't add layer.
7	Insufficient layer space. Can't add layer.
8	Can't send process log data while in process.

**Example:** Code 150 sent and received O.K.

Header	Address	Instruction	Length	Instruction Code Sent	Receive Code	Checksum
255 254	001	253	002	150	000	106

## 9.7 DEBUG COMPUTER INTERFACE

From the Program menu select the Interface button to get to a screen that will show all the sent and received RS-232 data. This may be helpful debugging any problems interfacing the 861 to a computer or PLC. This display is meant for low frequency messaging debugging, depending on the messages the debug computer interface display will not display all the messages under the maximum of 20 RS232 input messages a second. Displayed are the decimal number of each byte.

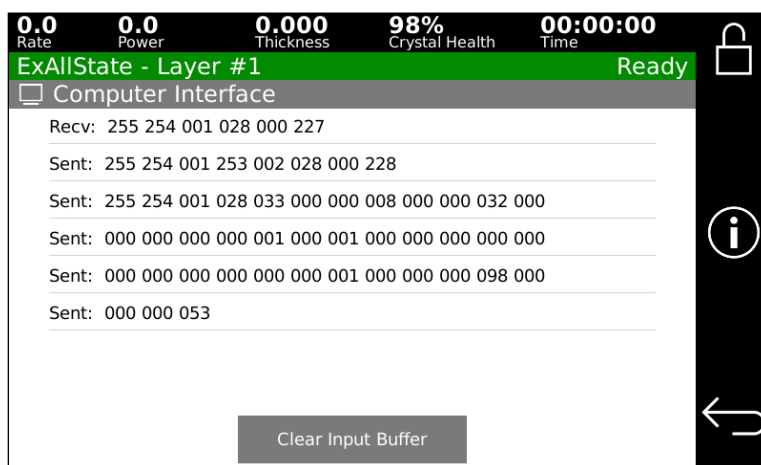

Figure 9-1, RS-232 Debug Computer Interface Screen

## 9.8 INSTRUCTION SUMMARY

The following table is a list of valid instruction codes



Instruction Code	Description
100	Remote activation of controller
1	Send controller hardware configuration
106	Send a material
107	Receive a material
108	Send a material list
110	Send a process
11	Receive a process
12	Delete a process
13	Send a process layer
14	Insert process layer
115	Replace a process layer
16	Delete a process layer
17	Send a process list
28	Send controller status
29	Start process
30	Send run-time values
31	Initiate automatic data logging
36	Send Process Log Directory
150	Delete a material
200	Query Numerical Value

The following table is a list of protocols that are 360/860 protocol compatible, but do not include new parameters. See legacy codes section for details.

Instruction Code	Description
0	Remote activation of controller
6	Send a material
7	Receive a material
8	Send a material list
10	Send a process
15	Replace a process layer

## 9.9 INSTRUCTION DESCRIPTIONS - STANDARD

The following is a description of all the valid instructions along with an example of how they are used. All the examples assume the controller address is 1. Note that modifying a process or material via the RS-232 interface should not be done while a process is running.

### 9.9.1 Remote activation of controller (Code #100)

This instruction initiates a button press of the 861. The valid button codes are shown in the following table:

Button Code A	Description
2	Manual button
4	Shutter button
8	Zero button
16	Reset button
32	Abort button

64	Start button
128	End Deposition

Button Code B not used at this time.

**Format:** Header, Address, Instruction=0, Length=1, Button Code A, Button Code B, Checksum

**Example:** To initiate instructions the computer would send bytes:

	Header	Address	Instruction	Length	Remote Activation Code A	Remote Activation Code B	Checksum
<b>Manual</b>	255 254	001	100	002	002	000	151
<b>Shutter</b>	255 254	001	100	002	004	000	149
<b>Zero</b>	255 254	001	100	002	008	000	145
<b>Reset</b>	255 254	001	100	002	016	000	137
<b>Abort</b>	255 254	001	100	002	032	000	121
<b>Start</b>	255 254	001	100	002	064	000	89
<b>End Deposition</b>	255 254	001	100	002	128	000	25
<b>Crystal Switch</b>	255 254	001	100	002	000	001	152

### 9.9.2 Send controller hardware configuration (Code #1)

Instructs the controller to send controller configuration data to the host computer. The following is a description of the configuration data:

Name	Length (bytes)	Message
Software Version	30	861 Software Version X.X.X
Source/Sensors	1	(2 or 4)
I/O Ports	1	(1 to 4)
Communication Port	1	1=RS232
Real Time Clock	1	1=Yes
Total 34 bytes		

Example: To instruct the controller to send the hardware configuration data the computer would send:

Header	Address	Instruction	Length	Checksum
255 254	001	001	000	254

### 9.9.3 Send a material (Code #106)

Instructs the controller to send all the material parameters for specified material to the host computer. A description of the material parameter list is in the table below:

Parameter name	Len bytes	Byte Offset	Decimal Pt. Position	Range	Units
Material #	1	0	*	0-98 (n-1)	Material # 1-99
Material Name	12	1	*		
Sensor #	1	13	*	1-4	None
Crystal #	1	14	*	1-8	None
Source #	1	15	*	1-4	None
Pocket #	1	16	*	1-30	None
Rate Establish Time	1	17	*	0-99	Seconds
Power Alarm Delay	1	18	*	0-99	Seconds
Sample Dwell %	1	19	*	0-99	%
Crystal Fail	1	20	*	4 = Halt 5 = TimePwr 6 = Switch 7 = SwitchTimePwr	
Backup Sensor #	1	21	*	1-4	None
Backup Crystal #	1	22	*	1-8	None
Crystal Marginal	1	23	*	0-99	%
Soak Sweep Pattern	1	24	*	0-63	
Predeposit Sweep Pattern	1	25	*	0-63	
Deposition Sweep Pattern	1	26	*	0-63	
Feed Sweep Pattern	1	27	*	0-63	
Material Density	2	28	2	80-9999	0.01 gm/cm3
Acoustic Impedance	2	30	2	400-9000	0.01 gm/cm2/sec
Tooling Factor	2	32	1	100-4999	0.1%
Proportional gain	2	34	*	0-9999	None
Integral Time constant	2	36	1	0-999	0.1 Seconds
Derivative Time constant	2	38	1	0-999	0.1 Seconds
Rise to Soak Time	2	40	*	0-35999	Seconds
Soak Power	2	42	1	0-999	0.1%
Soak Time	2	44	*	0-35999	Seconds
Rise to Predeposit Time	2	46	*	0-35999	Seconds
Predeposit Power	2	48	1	0-999	0.1%
Predeposit Time	2	50	*	0-35999	Seconds
Rate Establish Error %	2	52	1	0-999	0.1 Å/sec
Deposition Rate #1	2	54	1	0-9999	0.1 Å/sec
Deposition Rate #2	2	56	1	0-9999	0.1 Å/sec
Deposition Rate #3	2	58	1	0-9999	0.1 Å/sec
Deposition Rate #4	2	60	1	0-9999	0.1 Å/sec
Deposition Rate #5	2	62	1	0-9999	0.1 Å/sec
Time Setpoint	2	64	*	0-35999	Seconds
Ramp to Feed Time	2	66	*	0-35999	Seconds
Feed Power	2	68	1	0-999	0.1%
Feed Time	2	70	*	0-35999	Seconds
Ramp to Idle Time	2	72	*	0-35999	Seconds

Idle Power	2	74	1	0-999	0.1%
Maximum Power	2	76	1	0-999	0.1%
Minimum Power	2	78	1	0-999	0.1%
Rate Deviation Attention	2	80	1	0-999	0.1%
Rate Deviation Alarm	2	82	1	0-999	0.1%
Rate Deviation Abort	2	84	1	0-999	0.1%
Sample Period	2	86	*	0-35999	Seconds
Backup Tooling Factor	2	88	1	100-4999	0.1%
Ramp Start Thick. #1	3	90	3	0-999900	Å
Ramp Stop Thick #1	3	93	3	0-999900	Å
Ramp Start Thick. #2	3	96	3	0-999900	Å
Ramp Stop Thick #2	3	99	3	0-999900	Å
Ramp Start Thick. #3	3	102	3	0-999900	Å
Ramp Stop Thick #3	3	105	3	0-999900	Å
Ramp Start Thick. #4	3	108	3	0-999900	Å
Ramp Stop Thick #4	3	111	3	0-999900	Å
Thickness	3	114	3	0-999900	Å
Feed Enabled	1	117	*	0 = disabled, 1 = enabled	
Reserved	20	118		N/A	
Total		138	bytes		

Note: Rate ramps values larger than 999,900 Å will be clipped to 999,900 Å

\* - Indicates decimal point position is not applicable.

**Format:** Header, Address, Instruction=106, Length=1, Material #1-99 (0-98), Checksum.

**Example:** To instruct the controller to send the parameter list for material #10 the computer would send:

Header	Address	Instruction	Length	Material (n-1)	Checksum
255 254	001	106	001	009	139

### 9.9.4 Receive a material (Code #107)

Instructs the controller to enter all the incoming material parameters for material # n into memory. The parameters must be in the same order and format as the code 106 material parameter list table.

**Format:** Header, Address, Instruction=107, Length=111 (1 byte), Material#1-99 (0-98), 110 bytes parameter data, Checksum.

**Example:** To instruct the controller to receive a material the computer would send bytes:

Header	Address	Instruction	Length	Material#	Parameter Data	Checksum
255 254	001	107	138	(1 byte)	(137 bytes)	(1 byte)

### 9.9.5 Send material list (Code #108)

Instructs the controller to send a list of all material names in the order that they are stored in the controller. The material list consists of 12 character material names.

**Example:** To instruct the controller to send the material list the computer would send:

Header	Address	Instruction	Length	Checksum
255 254	001	108	000	147

Since the 861 message length is limited to 249 bytes, the controller will return the material list in 7 messages, of 16 materials each. The first message will contain material names 1-16, the second message will contain material names 17-32 and so on.

### 9.9.6 Send process (Code #110)

Instructs the controller to send all the process parameters for process# n to the host computer. A description of the process parameter list is as follows:

Parameter Name	Length (bytes)	Decimal Pt. Position	Range	Units
Process #	1	*	0-98	Process # 1-99
Process name	12	*	Characters	None
Number of Layers	2	*	0-998	Number Layers 1-999
Total	15 Bytes			

All of the layer data for process #n will follow the above message. Since the 861's message length is limited to 249 bytes, the controller will send the layer data in from one up to 21 separate messages depending on the number of layers in the process. Each message will contain from one to 49 layers. For example, if the process contains 250 layers, the controller will send the layer data in five messages. The first four messages will have 49 layers and the last message will have 5 layers. The format of the layer messages is as follows:

Parameter Name	Length (bytes)	Decimal Pt. Position	Range	Units
Message Number	1	*	1-17	Message number
Layer # n Thickness	3	3	0-999900	Å
Layer # n Material #	1	*	0-98 (n-1)	Material # 1-99
Layer # n Pocket Override	1	*	0-30	0 = use material pocket, 1-30 Pocket #

The message number is included as a safeguard to insure that the all messages are received and are in order.

**Example:** To instruct the controller to send the process parameters for process #6 the computer would send:

Header	Address	Instruction	Length	Process	Checksum
255 254	001	110	001	005	139

### 9.9.7 Receive process (Code #11)

Instructs the controller to enter the incoming parameters of process # *n* into memory. A description of the process parameter list is as follows:

Parameter Name	Length (bytes)	Decimal Pt. Position	RS-232 Range	Units
Process #	1	*	0-98 (n-1)	Process # 1-99
Process Name	12	*	Character	None
Not used	8	*		None
Total 21 bytes				

**Format:** Header, Address, Instruction=11, Length=21, 1 byte process#(0-98), 12 byte Process name(ASCII), unused 8 byte, Checksum.

**Example:**

Header	Address	Instruction	Length	Process #	Process name	Not Used	Checksum
255 254	001	011	021	(1 byte)	(12 bytes)	(8 bytes)	(1 byte)

To modify process layers you must use the insert, replace, and delete process layer instructions.

### 9.9.8 Delete process (Code #12)

Instructs the controller to delete process# *n* and its associated layers. Process number range 0-98

**Example:** To instruct the controller to delete process# 16 (RS-232 number is n-1) the computer would send:

Header	Address	Instruction	Length	Process	Checksum
255 254	001	012	001	015	227

### 9.9.9 Send process layer (Code #13)

Instructs the controller to send the process layer parameters for the specified process number and layer number to the host computer. A description of the process layer parameter list is as follows:

Parameter Name	Length (bytes)	Decimal Pt. Position	RS-232 Range	Units
Process #	1	*	0-98 (n-1)	Process # 1-99, RS-232
Layer #	2	*	0-998 (n-1)	Layer # 1-999, RS-232
Layer # <i>n</i> Thickness	3	3	0-999900	Å
Layer # <i>n</i> Material #	1	*	0-98 (n-1)	Material # 1-99, RS-232
Total 7 bytes				

**Format:** Header, Address, Instruction=13, Length=3, 1 byte Process #, 2 byte Layer #, Checksum.

**Example:** To instruct the controller to send the process layer parameters for process #16, layer #6 the computer would send:

Header	Address	Instruction	Length	Process #	Layer #	Checksum
255 254	001	013	003	015	000 005	219

### 9.9.10 Insert process layer (Code #14)

It is recommended to use the Code 106 for new systems.

Instructs the controller to insert the incoming layer of the specified process in front of specified layer (adding the layer to the process). A description of the insert process layer parameter list is as follows:

Parameter Name	Length (bytes)	Decimal Pt. Position	RS-232 Range	Units
Process #	1	*	0-98 (n-1)	Process # 1-99
Layer #	2	*	0-998 (n-1)	Layer # 1-999
Layer # n Thickness	3	3	0-999900	Å
Layer # n Material #	1	*	0-98 (n-1)	Material # 1-98
Total 7 bytes				

If all of the layers are defined then the controller will respond with an insufficient layer space error.

**Example:** To instruct the controller to insert the process layer parameters for process #3, layer #4, Thickness 250A, material #3 the computer would send:

Header	Address	Instruction	Length	Process	Layer	Layer Thickness	Layer Material	Checksum
255 254	001	014	007	002	000 003	000 000 250	002	233

### 9.9.11 Replace process layer (Code #115)

Instructs the controller to enter the incoming process layer parameters into specified process and specified layer. A description of the process layer parameter list is given above.

Writing a layer to an undefined process results in an error. To define a process use the Receive Process instruction.

**Example:** To instruct the controller to insert the process layer parameters for process #3, layer #4, Thickness 250A, material #3, and pocket override #1 the computer would send:

Header	Address	Instruction	Length	Process	Layer	Layer Thickness	Layer Material (n-1)	Pocket Override	Checksum
255 254	001	115	008	002	000 003	000 000 111	002	001	15

### 9.9.12 Delete process layer (Code #16)

Instructs the controller to delete specified layer from the specified process.

Format: Header, Address, Instruction=16, Length=3, 1 byte Process #(0-98), 2 byte Layer #(0-998), Checksum.

**Example:** To instruct the controller to delete the process #3, layer #4 the computer would send:

Header	Address	Instruction	Length	Process (n-1)	Layer (n-1)	Checksum
255 254	001	016	003	002	000 003	231

### 9.9.13 Send a process list (Code #17)

Instructs the controller to send all process names in the order that they are stored in the controller. The process list consists of 99 12 character process names.

Example: To instruct the controller to send the process list the computer would send:

Header	Address	Instruction	Length	Checksum
255 254	001	017	000	238

Since the 861's message length is limited to 249 bytes, the controller will send the process names in five separate messages. The first four messages will each contain 20 names and the last message will contain 19 names.

### 9.9.14 Send controller status (Code #28)

Instructs the controller to send the controller status data list. A description of the controller status data list is as follows:

Parameter Name	Length (bytes)	Range
Controller state	1	0 = Process ready 1 = Start layer 2 = Change pocket 3 = Change crystal 4 = Layer ready 5 = Soak rise 6 = Soak hold 7 = Rise to Predeposit 8 = Predeposit hold 9 = Establish rate 10 = Shutter Delay 11 = Deposit #1 12 = Rate ramp #1 13 = Deposit #2 14 = Rate ramp #2 15 = Deposit #3 16 = Rate ramp #3 17 = Deposit #4 18 = Rate ramp #4 19 = Deposit #5 20 = Ramp to feed 21 = Feed hold 22 = Ramp to idle 23 = Layer complete 24 = Process complete 25 = Process resume 26 = Initializing 27 = Set Soak Sweep



		28 = Set Predeposit Sweep 29 = Set Deposit Sweep 30 = Set Feed Sweep
Abort Process Errors	1	bit 6 = Max Rate&Min Pwr bit 7 = Min Rate&Max Pwr
Alarm 1 Errors	1	bit 3 = Crystal Fail, Process Halted bit 4 = Rate Establish Error
Alarm 2 Errors	1	bit 3 = Sound Alarm Action bit 4 = Rate Deviation Alarm bit 5 = Crystal Fail, Time Power Mode bit 6 = Sensor Fault bit 7 = source fault
Alert Errors	1	bit 3 = Sound Alert Action bit 4 = Minimum Power Alert bit 5 = Maximum Power Alert bit 6 = Rate Deviation Alert bit 7 = Crystal Marginal
Attention 1 Errors	1	bit 0 = Process Complete bit 1 = Minimum Power Attention bit 2 = Maximum Power Attention bit 3 = Rate Deviation Attention bit 4 = Crystal Marginal&!In Process bit 5 = Crystal Fail&! In Process bit 6 = Crystal Marginal&In Process, Switch bit 7 = Crystal Fail&In Process, Switch
Attention 2 Errors	1	bit 3 = Manual Crystal Change bit 4 = Resume Process bit 5 = Sound Attention bit 6 = Manual Pocket Change bit 7 = Pause on Layer Complete
Discrete Input Register 1	1	bit 0 = Input #1, ...8 ( 0=False, 1=True)
Discrete Input Register 2	1	bit 0 = Input #9, ...16 ( 0=False, 1=True)
Discrete Output Register 1	1	bit 0 = Output #1, ...8 ( 0=False, 1=True)
Discrete Output Register 2	1	bit 0 = Output #9, ...16 ( 0=False, 1=True)
Controller Status 1	1	bit 0 = Ready Mode bit 1 = Manual Mode bit 2 = Time Power Mode bit 3 = Hold Mode bit 4 = Halt Mode bit 5 = Abort Mode bit 6 = Power Control Mode bit 7 = In Process
Controller Status 2	1	bit 0 = Resume Process bit 1 = Simulate Mode bit 5 = Material Time Setpoint bit 6 = Backup Sensor Active bit 7 = Last Layer Of Process
Source #1 Pocket Position	1	1-30
Source #2 Pocket Position	1	1-30
Source #3 Pocket Position	1	1-30
Source #4 Pocket Position	1	1-30
Source #1 Power	2	0-4000, Power=99.9%*N/4000
Source #2 Power	2	0-4000, Power=99.9%*N/4000
Source #3 Power	2	0-4000, Power=99.9%*N/4000

Source #4 Power	2	0-4000, Power=99.9%*N/4000
Sensor #1 Crystal Position	1	1-8
Sensor #2 Crystal Position	1	1-8
Sensor #3 Crystal Position	1	1-8
Sensor #4 Crystal Position	1	1-8
Sensor #1 Crystal Health	1	0-99%
Sensor #2 Crystal Health	1	0-99%
Sensor #3 Crystal Health	1	0-99%
Sensor #4 Crystal Health	1	0-99%
Total 33 bytes		

**Format:** Header, Address, Instruction=28, Length=0, Checksum

**Example:** To instruct the controller to send the controller status the computer would send:

Header	Address	Instruction	Length	Checksum
255 254	001	028	000	227

### 9.9.15 Start process (Code #29)

Instructs the controller to start the specified process from specified layer.

**Format:** Header, Address, Instruction=29, Length=3, Process #(0-98) 1byte, Starting layer #(1-999) 2 bytes, Checksum.

**Example:** To instruct the controller to start process # 5 on layer # 10 the computer would send:

Header	Address	Instruction	Length	Process (n-1)	Layer	Checksum
255 254	001	029	003	004	000 009	210

### 9.9.16 Send run-time values (Code #30)

Instructs the controller to send the run-time value list one time. A description of the run-time value list is as follows:

Value Name	Length (bytes)	Format	Units
Power	4	String	%
Thickness	5	String	KÅ
Deposition rate	4	String	Å/sec
Time to go	7	String	Seconds
Crystal health	2	String	%
Layer number	3	String	None
Rate deviation	4	String	%
Active process number	1	0-98 (n-1)	Process # 1-99
Active material number	1	0-98 (n-1)	Material # 1-99
Active sensor number	1	1-4	
Active crystal number	1	1-8	
Active source number	1	1-4	
Active pocket number	1	1-30	

	Total 35 bytes		
--	----------------	--	--

The string values are in ASCII format, including decimal points and colons.

Example: To instruct the controller to send the run-time value list the computer would send:

Header	Address	Instruction	Length	Checksum
255 254	001	030	000	225

### 9.9.17 Initiate Automatic Data Logging (Code #31)

This operation allows the computer to setup the 861 to automatically output selected values to the RS232 port every at the rate that is set in Setup – Utility - Data Points/Minute. A “stop” command must be sent to stop the 861 from sending data.

The values sent are determined by the bit value of the message byte in the data logging instruction message.

Byte #	Bit #	Description	Length(bytes)	Format	Units
1	0	Power	4	String	%
	1	Thickness	5	String	KÅ
	2	Deposition rate	4	String	Å/sec
	3	Time to go	7	String	Seconds
	4	Crystal health	2	String	%
	5	Layer number	3	String	None
	6	Rate deviation	4	String	%
	7	Frequency	10	String	Hz

All values are in ASCII format including decimal points or colons.

**Example:** to instruct the 861 to output rate and power the computer would send the following message:

Header	Address	Instruction	Length	Start Logging	Checksum
255 254	001	031	001	005	218

Data logging is stopped by sending the following message:

Header	Address	Instruction	Length	Stop Logging	Checksum
255 254	001	031	001	000	223

### 9.9.18 Send Process Log Directory (Code #36)

Instructs the controller to send the process log directory to the host computer. The process log directory consists of 16 individual process logs. The data format of a process log is listed in the following table:

Parameter Name	Length (bytes)	RS-232 Range	Units
Process Log Name	12	All ASCII Characters	
Process Run Number	2	1-9999	
Starting Time	3	00:00:00-23:59:59	HH:MM:SS
Starting Date	3	01/01/00-12/31/99	MM:DD:YY

Completion Time	3	00:00:00-23:59:59	HH:MM:SS
Completion Status	1	0=Normal, 1=Aborted	
Data Points/Minute	1	38=30ppm, 39=60ppm, 40=120ppm, 41=300ppm, 42=600ppm, 255=other	
Starting Layer Number	2	0-999	Layer # 1-999
Ending Layer Number	2	0-999	Layer # 1-999
Total 29 bytes			

Each byte in the time and date data is an integer value representing hour, minute, second, month, day, or year. The process run number and layer numbers are 2-byte integers.

If the first byte of the process name of any process log is equal to 255 then that log is considered blank.

Since the 861's message length is limited to 249 bytes, the controller will send the process log directory data in two separate 232 byte messages. The first message will contain the first eight logs and the second message will contain the last eight logs.

**Example:** To instruct the controller to send the process log directory the computer would send:

Header	Address	Instruction	Length	Checksum
255 254	001	036	000	219

### 9.9.19 Send run-time values (Code #39)

Instructs the controller to send one run-time value base on the value# received.

Header	Address	Instruction	Length	Value#	Checksum
255 254	001	039	001	005	210

A description of the run-time value list is as follows:

Value#	Value Name	Length (bytes)	Format	Units
0	Power	4	String	%
1	Thickness	5	String	KA
2	Deposition rate	4	String	A/sec
3	Time to go	7	String	Seconds
4	Crystal health	2	String	%
5	Layer number	3	String	None
6	Rate deviation	4	String	%
7	Active process number	1	0-98 (n-1)	
8	Active material number	1	0-98 (n-1)	
9	Active sensor number	1	1-4	
10	Active crystal number	1	1-8	
11	Active source number	1	1-4	
12	Active pocket number	1	1-30	
13	Frequency	10	String	Hz

### 9.9.20 Delete a material (Code #150)

Instructs the controller to delete requested material. Material number range #1-99 (byte 0-98)

**Example:** To instruct the controller to delete material# 16 the computer would send:

Header	Address	Instruction	Length	Material (n-1)	Checksum
255 254	001	150	001	015	089

### 9.9.21 Select Process (Code #151)

Instructs the controller to select process

It has two data bytes:

Byte 0 = "Process or Film": 1 - Process, 0 - Film.

Byte 1 = process/film number. Process/film number range #1-99 (byte 0-98)

**Example:** To instruct the controller to select film# 16 the computer would send:

Header	Address	Instruction	Length	Process or Film	Process or Film (n-1)	Checksum
255 254	001	151	002	000	015	087

### 9.9.22 Query Numerical Value (Code #200)

Instructs the controller to send a queried numerical value.

Parameter name	Value id	Range	Units
Data Points/Min	0	30-600	Data Points/Min
System State	1		Returns a 3-byte int (then 1 unused byte) in the value field. The first byte is the same as "Controller Status 1", the second the same as "Controller Status 2", and the third the same as "Controller state". See Code #28 to decode.
Run Id	2	1-999	

**Example:** To instruct the controller to send "Data Points/Min" then send:

Header	Address	Instruction	Length	Value id	Checksum
255 254	001	200	004	000 000	51

The 861 will then send:

Header	Address	Instruction	Length	Value id	Value	Checksum
255 254	001	200	006	000 000	000 000 000 030	19

## 9.10 INSTRUCTION DESCRIPTIONS – LEGACY CODES

### 9.10.1 Remote activation of controller (Code #0)

This instruction initiates a button press of the 861. The valid button codes are shown in the following table:

Button Code	Description
2	Manual button

4	Shutter button
8	Zero button
16	Reset button
32	Abort button
64	Start button

**Format:** Header, Address, Instruction=0, Length=1, Button Code, Checksum

**Example:** To initiate instructions the computer would send bytes:

	Header	Address	Instruction	Length	Remote Activation Code	Checksum
<b>Manual</b>	255 254	001	000	001	002	252
<b>Shutter</b>	255 254	001	000	001	004	250
<b>Zero</b>	255 254	001	000	001	008	246
<b>Reset</b>	255 254	001	000	001	016	238
<b>Abort</b>	255 254	001	000	001	032	222
<b>Start</b>	255 254	001	000	001	064	190

### 9.10.2 Send a material (Code #6)

(360/860 protocol, see code #106 for new installations)

Instructs the controller to send all the material parameters for material # n to the host computer. A description of the material parameter list is in the table below:

Parameter name	Len bytes	Byte Offset	Decimal Pt. Position	Range	Units
Material #	1	0	*	0-98 (n-1)	Material # 1-99
Material Name	10	1	*		
Sensor #	1	11	*	1-4	None
Crystal #	1	12	*	1-8	None
Source #	1	13	*	1-4	None
Pocket #	1	14	*	1-30	None
Rate Establish Time	1	15	*	0-99	Seconds
Power Alarm Delay	1	16	*	0-99	Seconds
Sample Dwell %	1	17	*	10-100	%
Crystal Fail	1	18	*	4 = Halt 5 =TimePwr 6 =Switch	
Backup Sensor #	1	19	*	1-4	None
Backup Crystal #	1	20	*	1-8	None
Material Density	2	21	2	80-9999	0.01 gm/cm3
Acoustic Impedance	2	23	2	400-5999	0.01 gm/cm2/sec
Tooling Factor	2	25	1	100-4999	0.1%
Proportional gain	2	27	*	0-9999	None
Integral Time constant	2	29	1	0-999	0.1 Seconds
Derivative Time constant	2	31	1	0-999	0.1 Seconds
Rise to Soak Time	2	33	*	0-35999	Seconds
Soak Power	2	35	1	0-999	0.1%
Soak Time	2	37	*	0-35999	Seconds
Rise to Predeposit Time	2	39	*	0-35999	Seconds

Predeposit Power	2	41	1	0-999	0.1%
Predeposit Time	2	43	*	0-35999	Seconds
Rate Establish Error %	2	45	1	0-999	0.1 Å/sec
Deposition Rate #1	2	47	1	0-9999	0.1 Å/sec
Deposition Rate #2	2	49	1	0-9999	0.1 Å/sec
Deposition Rate #3	2	51	1	0-9999	0.1 Å/sec
Deposition Rate #4	2	53	1	0-9999	0.1 Å/sec
Deposition Rate #5	2	55	1	0-9999	0.1 Å/sec
Time Setpoint	2	57	*	0-35999	Seconds
Ramp to Feed Time	2	59	*	0-35999	Seconds
Feed Power	2	61	1	0-999	0.1%
Feed Time	2	63	*	0-35999	Seconds
Ramp to Idle Time	2	65	*	0-35999	Seconds
Idle Power	2	67	1	0-999	0.1%
Maximum Power	2	69	1	0-999	0.1%
Minimum Power	2	71	1	0-999	0.1%
Rate Deviation Attention	2	73	1	0-999	0.1%
Rate Deviation Alarm	2	75	1	0-999	0.1%
Rate Deviation Abort	2	77	1	0-999	0.1%
Sample Period	2	79	*	0-35999	Seconds
Backup Tooling Factor	2	81	1	100-4999	0.1%
Ramp Start Thick. #1	3	83	3	0-999900	Å
Ramp Stop Thick #1	3	86	3	0-999900	Å
Ramp Start Thick. #2	3	89	3	0-999900	Å
Ramp Stop Thick #2	3	92	3	0-999900	Å
Ramp Start Thick. #3	3	95	3	0-999900	Å
Ramp Stop Thick #3	3	98	3	0-999900	Å
Ramp Start Thick. #4	3	101	3	0-999900	Å
Ramp Stop Thick #4	3	104	3	0-999900	Å
Not used	4	107		N/A	
Total		111	bytes		

Note: Rate ramps values larger than 999,900 Å will be clipped to 999,900 Å

\* - Indicates decimal point position is not applicable.

**Format:** Header, Address, Instruction=6, Length=1, Material #(0-98), Checksum.

**Example:** To instruct the controller to send the parameter list for material #16 the computer would send:

Header	Address	Instruction	Length	Material	Checksum
255 254	001	006	001	015	233

### 9.10.3 Receive a material (Code #7)

(360/860 protocol, see code #107 for new installations)

Instructs the controller to enter all the incoming material parameters for material # n into memory. The parameters must be in the same order and format as the above material parameter list.

Note: Backup sensor's Tooling Factor will be set to the minimum tooling factor if it is too low.

If sensor, crystal, source or pocket has the number 0 it will be set to 0.

**Format:** Header, Address, Instruction=7, Length=111 (1 byte), Material# (0-31),110 bytes parameter data, Checksum.

**Example:** To instruction the computer would send bytes:

Header	Address	Instruction	Length	Material#	Parameter Data	Checksum
255 254	001	007	111	(1 byte, n-1)	(110 bytes)	(1 byte)

### 9.10.4 Send material list (Code #8)

(360/860 protocol, see code #108 for new installations)

Instructs the controller to send a list of all material names in the order that they are stored in the controller. The material list consists of the first 32 10 character material names. The 861 can have 12 character material names, only 10 characters will be transmitted with this code.

**Example:** To instruct the controller to send the material list the computer would send:

Header	Address	Instruction	Length	Checksum
255 254	001	008	000	247

Since the 861 message length is limited to 249 bytes, the controller will return the material list in two messages. The first message will contain material names 1-16 and the second message will contain material names 17-32.

### 9.10.5 Send process (Code #10)

(360/860 protocol, see code #110 for new installations)

Instructs the controller to send all the process parameters for process# n to the host computer. A description of the process parameter list is as follows:

Parameter Name	Length (bytes)	Decimal Pt. Position	Range	Units
Process #	1	*	0-98	Process # 1-99
Process name	12	*	Characters	None
Not used	8	*		None
Number of Layers	2	*	0-998	Number Layers 1-999
Total	23 bytes			

All of the layer data for process #n will follow the above message. Since the 861's message length is limited to 249 bytes, the controller will send the layer data in from one up to 17 separate messages depending on the number of layers in the process. Each message will contain from one to 60 layers. For example, if the process contains 250 layers, the controller will send the layer data in five messages. The first four message will have 60 layers and the last message will have 10 layers. The format of the layer messages is as follows:



Parameter Name	Length (bytes)	Decimal Pt. Position	Range	Units
Message Number	1	*	1-17	None
Layer # n Thickness	3	3	0-999900	Å
Layer # n Material #	1	*	0-98	Material # 1-99

The message number is included as a safeguard to insure that the all messages are received and are in order.

**Example:** To instruct the controller to send the process parameters for process #16 the computer would send:

Header	Address	Instruction	Length	Process	Checksum
255 254	001	010	001	015	229

### 9.10.6 Replace process layer (Code #15)

(360/860 protocol, see code #115 for new installations)

Instructs the controller to enter the incoming process layer parameters into the specified process and layer number. A description of the process layer parameter list is given above.

Writing a layer to an undefined process results in an error. To define a process use the Receive Process instruction.

**Example:** To instruct the controller to insert the process layer parameters for process #3, layer #4, Thickness 250A, material #3 the computer would send:

Header	Address	Instruction	Length	Process (n-1)	Layer (n-1)	Layer Thickness	Layer Material (n-1)	Checksum
255 254	001	015	007	002	000 003	000 000 111	002	115

## 10 360C SERIAL INTERFACE

---

### 10.1 GENERAL

---

The 861 comes standard with an RS-232 serial interface. The serial computer interface of the Telemark 861 Deposition Controllers permits remote control using a personal computer or process controller. The protocol is changed in the Utility menu under Serial Protocol.

There are four types of protocols: Standard, 360C, ASCII Checksum and ASCII No Checksum. This chapter deals with the 360C protocol.

### 10.2 RS-232 SERIAL INTERFACE

---

The standard RS-232 serial interface of the 861 allows one 861 to be connected to any other device with a RS-232 serial interface. A D9P connector is provided on the rear panel for permanent connection to the host computer. See figure 3-5.

The 861 acts as DTE, and, accordingly, the 9-pin connector has 'plug' pins. It can be used with a DCE or a DTE host cable connection providing the sense of the RxD/TxD data lines and the control lines is observed. Pin 2 'TxD' transmits data from the 861 to the host; pin 3 'RxD' receives data from the host. Pin 7 'CTS' is a control output signal from the 861, and pin 8 'RTS' is a control input signal.

In this implementation, pin 7 'CTS' means what it says, namely, this is an output control line, and when the 861 asserts this control line 'true' the host can transmit to the 861. On the other hand, pin 8 'RTS' is not quite what it may seem because this is a signal input to the 861, and it is intended that the host should assert this line 'true' only when the 861 is allowed to transmit data to the host. The 861 does not generate an RTS 'request-to-send' as such for the host PC, so the host should assert pin 8 true whenever the 861 is allowed to transmit to the host, without being asked to do so.

The 861's RS-232 port is automatically set up to operate with the following specifications:

8 Bit data, No Parity, 1 Stop bit

In the utility menu the baud rate is selectable 9600, 19200, 38400, 57600, or 115200.

The 861 will process a maximum of 20 RS-232 input messages a second.

### 10.3 PROTOCOL

---

All communications between the computer and the 861 are in bytes.

Example: To initiate a zero thickness instruction the computer would send the following bytes shown below. Different formats are shown that are used in different programming environments.

	Header	Interface Address	Instruction	Length	Message	Checksum
<b>Decimal Bytes</b>	255 254	001	000	001	008	246
<b>Character String</b>	Chr\$(255) Chr\$(254)	Chr\$(1)	Chr\$(0)	Chr\$(1)	Chr\$(8)	Chr\$(246)
<b>Siemens IPC</b>	ÿ þ	\$01	\$00	\$01	\$08	ö
<b>Hex</b>	FF FE	01	00	01	08	DE

**Header** - Two byte header – FF FE i.e. decimal bytes 255 254

**Interface Address** - One byte controller address - The controller address byte defines the controller that should receive the message, or should respond to the message by transmitting data. The controller address will range from 0 to 32 (set via Edit System Setup, Edit Utility Setup, Interface Address).

**Instruction** - One byte instruction code.

**Length** - One byte message length.

**Message** - 0-249 byte message.

**Checksum** - One byte checksum, for the instruction code byte, message length byte and the 0-249 byte message.

The checksum is the two's complement of the one byte sum of all bytes from, and including, the instruction code to the end of the message. If the one byte sum of all these bytes is added to the checksum, the result should equal 255.

A single byte checksum can be generated using the calculation:

$$\text{checksum} = 255 - (\text{sum of all but the header bytes} \% 256) + 1,$$

i.e. the checksum is the bit inversion of the remainder byte which results from dividing the sum of all bytes by 256.

In Excel the check some can be calculated by:

$$=(255-MOD(SUM(a11 but the header bytes),256))+1$$

## 10.4 DATA TYPES

---

There are three data types sent over RS-232: one byte, two byte, and three byte parameters. All data types are sent as integers in binary format with the most significant byte first. The one byte data types are either ASCII characters, numeric values (0-255), or 8 bit registers. Some of the multiple byte data types are decimal values stored as integers. To convert these values to their decimal equivalent, use the following equation:

$$\text{Decimal value} = (\text{Integer value}) / (10^{\text{DP}})$$

where DP is the value's decimal point position. The decimal point positions for all the parameters are constant and are given in tables along with the parameters' range.

## 10.5 MESSAGE RECEIVED STATUS

---

Following the receipt of each message, the controller will send a one-byte 'received status' message, indicating how the message was received, with the following format:

**Format:**

Header - Two byte header – FF FE i.e. decimal bytes 255 254

Interface Address One byte controller address

Instruction Code = 253

Length = 2

Instruction Code of the received message

Receive code, see table below

Checksum

A value of 253 for the instruction byte indicates that this is a received status message.

The Instruction Code byte indicates the instruction code of the message that was received.

The following table shows a list of possible receive codes:

Receive Code	Description
0	Message received O.K.
1	Invalid checksum.
2	Invalid instruction code.
3	Invalid message length.
4	Parameter(s) out of range.
5	Invalid message.
6	Process undefined. Can't add layer.
7	Insufficient layer space. Can't add layer.
8	Can't send process log data while in process.

**Example:** Code 150 sent and received O.K.

Header	Address	Instruction	Length	Instruction Code Sent	Receive Code	Checksum
255 254	001	253	002	150	000	106

## 10.6 DEBUG COMPUTER INTERFACE

From the Program menu select the Interface button to get to a screen that will show all the sent and received RS-232 data. This may be helpful debugging any problems interfacing the 861 to a computer or PLC. This display is meant for low frequency messaging debugging, depending on the messages the debug computer interface display will not display all the messages under the maximum of 20 RS232 input messages a second. Displayed are the decimal number of each byte.

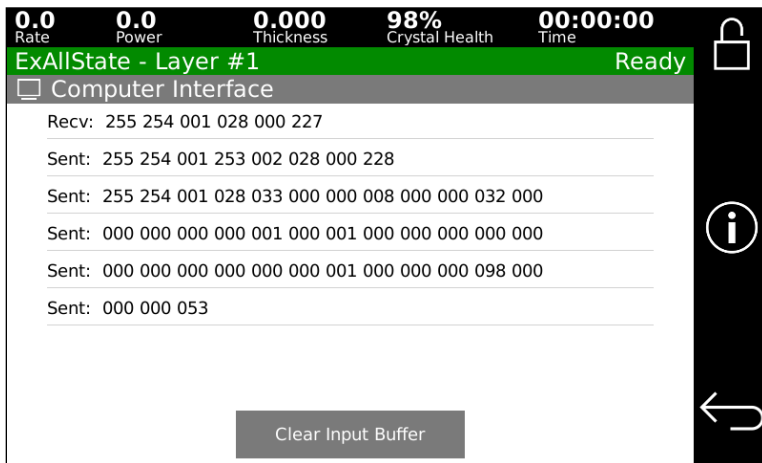

Figure 10-1, RS-232 Debug Computer Interface Screen

## 10.7 INSTRUCTION SUMMARY

The following table is a list of valid instruction codes

Instruction Code	Description
0	Remote activation of controller
6	Send a material
7	Receive a material
8	Send a material list
10	Send a process
11	Receive a process
12	Delete a process
13	Send a process layer
14	Insert process layer
15	Replace a process layer
16	Delete a process layer
17	Send a process list
28	Send controller status
29	Start process
30	Send run-time values
36	Send Process Log Directory
150	Delete a material

The 360C compatible protocol codes above do not include parameters new to the 861. See chapter 8 for details on the codes that include the new 861 parameters.

Instruction Code	Description
106	Send a material
107	Receive a material
108	Send a material list
110	Send a process
115	Replace a process layer

## 10.8 INSTRUCTION DESCRIPTIONS – 360C

The following is a description of all the valid instructions along with an example of how they are used. All the examples assume the controller address is 1. Note that modifying a process or material via the RS-232 interface should not be done while a process is running.

### 10.8.1 Remote activation of controller (Code #0)

This instruction initiates a button press of the 861. The valid button codes are shown in the following table:

Button Code	Description
2	Manual button
4	Shutter button
8	Zero button
16	Reset button
32	Abort button
64	Start button

**Format:** Header, Address, Instruction=0, Length=1, Button Code, Checksum

**Example:** To initiate instructions the computer would send bytes:

	Header	Address	Instruction	Length	Remote Activation Code	Checksum
<b>Manual</b>	255 254	001	000	001	002	252
<b>Shutter</b>	255 254	001	000	001	004	250
<b>Zero</b>	255 254	001	000	001	008	246
<b>Reset</b>	255 254	001	000	001	016	238
<b>Abort</b>	255 254	001	000	001	032	222
<b>Start</b>	255 254	001	000	001	064	190

### 10.8.2 Send a material (Code #6)

Instructs the controller to send all the material parameters for specified material to the host computer. A description of the material parameter list is in the table below:

Parameter name	Len bytes	Byte Offset	Decimal Pt. Position	Range	Units
Material #	1	0	*	0-98 (n-1)	Material # 1-99
Material Name	10	1	*		
Source #	1	11	*	1-4	None

Pocket #	1	12	*	1-30	None
Rate Establish Time	1	13	*	0-99	Seconds
Power Alarm Delay	1	14	*	0-99	Seconds
Sample Dwell %	1	15	*	10-100	%
Ramp Start Thick. #1	1	16	1	0-100	%
Ramp Stop Thick #1	1	17	1	0-100	%
Ramp Start Thick. #2	1	18	1	0-100	%
Ramp Stop Thick #2	1	19	1	0-100	%
Ramp Start Thick. #3	1	20	1	0-100	%
Ramp Stop Thick #3	1	21	1	0-100	%
Ramp Start Thick. #4	1	22	1	0-100	%
Ramp Stop Thick #4	1	23	1	0-100	%
Sensor#1 Crystal Fail	1	24	*	2 = Not Used 3 = Disabled 5 = Halt 6 =TimePwr 7 =Switch	
Sensor#1 Crystal #	1	25	*	1-8	None
Sensor#1 Backup Sensor #	1	26	*	1-4	None
Sensor#1 Backup Crystal #	1	27	*	1-8	None
Sensor#2 Crystal Fail	1	28	*	2 = Not Used 3 = Disabled 5 = Halt 6 =TimePwr 7 =Switch	
Sensor#2 Crystal #	1	29	*	1-8	None
Sensor#2 Backup Sensor #	1	30	*	1-4	None
Sensor#2 Backup Crystal #	1	31	*	1-8	None
Sensor#3 Crystal Fail	1	32	*	2 = Not Used 3 = Disabled 5 = Halt 6 =TimePwr 7 =Switch	
Sensor#3 Crystal #	1	33	*	1-8	None
Sensor#3 Backup Sensor #	1	34	*	1-4	None
Sensor#3 Backup Crystal #	1	35	*	1-8	None
Sensor#4 Crystal Fail	1	36	*	2 = Not Used 3 = Disabled 5 = Halt 6 =TimePwr 7 =Switch	
Sensor#4 Crystal #	1	37	*	1-8	None
Sensor#4 Backup Sensor #	1	38	*	1-4	None
Sensor#4 Backup Crystal #	1	39	*	1-8	None
Not used	8	40			
Material Density	2	48	2	80-9999	0.01 gm/cm3
Acoustic Impedance	2	50	2	400-5999	0.01 gm/cm2/sec
Tooling Factor	2	52	1	100-4999	0.1%
Proportional gain	2	54	*	0-9999	None
Integral Time constant	2	56	1	0-999	0.1 Seconds
Derivative Time constant	2	58	1	0-999	0.1 Seconds

Rise to Soak Time	2	60	*	0-35999	Seconds
Soak Power	2	62	1	0-999	0.1%
Soak Time	2	64	*	0-35999	Seconds
Rise to Predeposit Time	2	66	*	0-35999	Seconds
Predeposit Power	2	68	1	0-999	0.1%
Predeposit Time	2	70	*	0-35999	Seconds
Rate Establish Error %	2	72	1	0-999	0.1 Å/sec
Deposition Rate #1	2	74	1	0-9999	0.1 Å/sec
Deposition Rate #2	2	76	1	0-9999	0.1 Å/sec
Deposition Rate #3	2	78	1	0-9999	0.1 Å/sec
Deposition Rate #4	2	80	1	0-9999	0.1 Å/sec
Deposition Rate #5	2	82	1	0-9999	0.1 Å/sec
Time Setpoint	2	84	*	0-35999	Seconds
Ramp to Feed Time	2	86	*	0-35999	Seconds
Feed Power	2	88	1	0-999	0.1%
Feed Time	2	90	*	0-35999	Seconds
Ramp to Idle Time	2	92	*	0-35999	Seconds
Idle Power	2	94	1	0-999	0.1%
Maximum Power	2	96	1	0-999	0.1%
Minimum Power	2	98	1	0-999	0.1%
Rate Deviation Attention	2	100	1	0-999	0.1%
Rate Deviation Alarm	2	102	1	0-999	0.1%
Rate Deviation Abort	2	104	1	0-999	0.1%
Sample Period	2	106	*	0-35999	Seconds
Sensor #1 Tooling	2	108	1	100-4999	0.1%
Sensor #1 Weight	2	110	1	0-4999	0.1%
Sensor #2 Tooling	2	112	1	100-4999	0.1%
Sensor #2 Weight	2	114	1	0-4999	0.1%
Sensor #3 Tooling	2	116	1	100-4999	0.1%
Sensor #3 Weight	2	118	1	0-4999	0.1%
Sensor #4 Tooling	2	120	1	100-4999	0.1%
Sensor #4 Weight	2	122	1	0-4999	0.1%
Not used	12	124		N/A	
Total		13636	bytes		

\* - Indicates decimal point position is not applicable.

**Format:** Header, Address, Instruction=6, Length=1, Material #(0-98), Checksum.

**Example:** To instruct the controller to send the parameter list for material #16 the computer would send:

Header	Address	Instruction	Length	Material	Checksum
255 254	001	006	001	015	233

Notes:

- For the sensor # that is the primary sensor for the material, its Crystal Fail, Crystal #, Backup Sensor #, and Backup Crystal # are set according to the 861's material data. For the sensor # that is the backup sensor for the material, its Crystal Fail is set to Not Used (2), Crystal # is set to the Backup Crystal #, Backup Sensor # is set to 1, and Backup



Crystal # is set 1. The other four unused sensors' Crystal Fail is set to Not Used (2), and the rest of those sensors' data should not be accessed.

- The 861 material's Tooling Factor is set as the tooling factor for the material's primary sensor. The 861 material's Backup Tooling Factor is set as the tooling factor for the material's backup sensor. All other sensors' tooling factors are set to 0. The common tooling factor is assumed to be 100.

- The weight for the 861 material's primary sensor is set to 100. All other weights are set to 0.

- If Feed Enabled is set to Disabled, then the "ramp to idle" parameters are moved to the "ramp to feed" parameters, in order to maintain the same behavior for the material (so the power doesn't drop to 0 in the feed state). "Feed Enabled" should always be set to true for 360C-compatible systems that use RS232, in order to avoid confusion from the migrating parameters.

### 10.8.3 Receive a material (Code #7)

Instructs the controller to enter all the incoming material parameters for material # n into memory. The parameters must be in the same order and format as the above material parameter list.

**Format:** Header, Address, Instruction=7, Length=111 (1 byte), Material# (0-31),110 bytes parameter data, Checksum.

**Example:** To instruction the computer would send bytes:

Header	Address	Instruction	Length	Material#	Parameter Data	Checksum
255 254	001	007	111	(1 byte, n-1)	(110 bytes)	(1 byte)

Notes:

- Ramp thicknesses not set from material data (set to default material values)

- The sensor for a material (primary sensor) is set to the sensor with the greatest weight (smallest sensor # if several sensors have the same weight). The 861 uses Sensor 1 - 4 only, it does not look at sensor 5 & 6 data since the 861 only has sensors 1 - 4. The crystal is set to the primary sensor's primary crystal. The crystal fail state is only set to Switch if the primary sensor has valid backup sensor and crystal data, otherwise it defaults to Halt and a user error is logged.

Each sensor's (primary and backup) tooling factor is set to (the common tooling factor / 100) \* Sensor N Tooling Factor. Note that if a material is downloaded and read back, the common tooling factor read back will always be 100 and the backup and primary sensors' tooling factors will have been adjusted by the downloaded common tooling factor.

### 10.8.4 Send material list (Code #8)

Instructs the controller to send a list of all material names in the order that they are stored in the controller. The material list consists of the first 32 10 character material names. The

861 can have 12 character material names, only 10 characters will be transmitted with this code.

**Example:** To instruct the controller to send the material list the computer would send:

Header	Address	Instruction	Length	Checksum
255 254	001	008	000	247

Since the 861 message length is limited to 249 bytes, the controller will return the material list in two messages. The first message will contain material names 1-16 and the second message will contain material names 17-32.

### 10.8.5 Send process (Code #10)

Instructs the controller to send all the process parameters for process# n to the host computer. A description of the process parameter list is as follows:

Parameter Name	Length (bytes)	Decimal Pt. Position	Range	Units
Process #	1	*	0-98	Process # 1-99
Process name	12	*	Characters	None
Not used	8	*		None
Number of Layers	2	*	0-998	Number Layers 1-999
Total	23 bytes			

All of the layer data for process #n will follow the above message. Since the 861's message length is limited to 249 bytes, the controller will send the layer data in from one up to 17 separate messages depending on the number of layers in the process. Each message will contain from one to 60 layers. For example, if the process contains 250 layers, the controller will send the layer data in five messages. The first four message will have 60 layers and the last message will have 10 layers. The format of the layer messages is as follows:

Parameter Name	Length (bytes)	Decimal Pt. Position	Range	Units
Message Number	1	*	1-17	None
Layer # n Thickness	3	3	0-999900	Å
Layer # n Material #	1	*	0-98	Material # 1-99

The message number is included as a safeguard to insure that the all messages are received and are in order.

**Example:** To instruct the controller to send the process parameters for process #16 the computer would send:

Header	Address	Instruction	Length	Process	Checksum
255 254	001	010	001	015	229

### 10.8.6 Receive process (Code #11)

Instructs the controller to enter the incoming parameters of process # n into memory. A description of the process parameter list is as follows:

Parameter Name	Length (bytes)	Decimal Pt. Position	RS-232 Range	Units
Process #	1	*	0-98 (n-1)	Process # 1-99
Process Name	12	*	Character	None
Not used	8	*		None
Total 21 bytes				

**Format:** Header, Address, Instruction=11, Length=21, 1 byte process#(0-98), 12 byte Process name(ASCII), unused 8 byte, Checksum.

**Example:**

Header	Address	Instruction	Length	Process #	Process name	Not Used	Checksum
255 254	001	011	021	(1 byte)	(12 bytes)	(8 bytes)	(1 byte)

To modify process layers you must use the insert, replace, and delete process layer instructions.

**10.8.7 Delete process (Code #12)**

Instructs the controller to delete process# n and its associated layers. Process number range 0-98

**Example:** To instruct the controller to delete process# 16 (RS-232 number is n-1) the computer would send:

Header	Address	Instruction	Length	Process	Checksum
255 254	001	012	001	015	227

**10.8.8 Send process layer (Code #13)**

Instructs the controller to send the process layer parameters for the specified process number and layer number to the host computer. A description of the process layer parameter list is as follows:

Parameter Name	Length (bytes)	Decimal Pt. Position	RS-232 Range	Units
Process #	1	*	0-98 (n-1)	Process # 1-99, RS-232
Layer #	2	*	0-998 (n-1)	Layer # 1-999, RS-232
Layer # n Thickness	3	3	0-999900	Å
Layer # n Material #	1	*	0-98 (n-1)	Material # 1-99, RS-232
Total 7 bytes				

**Format:** Header, Address, Instruction=13, Length=3, 1 byte Process #, 2 byte Layer #, Checksum.

**Example:** To instruct the controller to send the process layer parameters for process #16, layer #6 the computer would send:

Header	Address	Instruction	Length	Process #	Layer #	Checksum
255 254	001	013	003	015	000 005	219

### 10.8.9 Insert process layer (Code #14)

Instructs the controller to insert the incoming layer of the specified process in front of specified layer (adding the layer to the process). A description of the insert process layer parameter list is as follows:

Parameter Name	Length (bytes)	Decimal Pt. Position	RS-232 Range	Units
Process #	1	*	0-98 (n-1)	Process # 1-99
Layer #	2	*	0-998 (n-1)	Layer # 1-999
Layer # n Thickness	3	3	0-999900	Å
Layer # n Material #	1	*	0-98 (n-1)	Material # 1-98
Total 7 bytes				

If all of the layers are defined then the controller will respond with and insufficient layer space error.

**Example:** To instruct the controller to insert the process layer parameters for process #3, layer #4, Thickness 250A, material #3 the computer would send:

Header	Address	Instruction	Length	Process	Layer	Layer Thickness	Layer Material	Checksum
255 254	001	014	007	002	000 003	000 000 250	002	233

### 10.8.10 Replace process layer (Code #15)

Instructs the controller to enter the incoming process layer parameters into the specified process and layer number. A description of the process layer parameter list is given above.

Writing a layer to an undefined process results in an error. To define a process use the Receive Process instruction.

**Example:** To instruct the controller to insert the process layer parameters for process #3, layer #4, Thickness 250A, material #3 the computer would send:

Header	Address	Instruction	Length	Process (n-1)	Layer (n-1)	Layer Thickness	Layer Material (n-1)	Checksum
255 254	001	015	007	002	000 003	000 000 111	002	115

### 10.8.11 Delete process layer (Code #16)

Instructs the controller to delete specified later from the specified process.

Format: Header, Address, Instruction=16, Length=3, 1 byte Process #(0-98), 2 byte Layer #(0-998), Checksum.

**Example:** To instruct the controller to delete the process #3, layer #4 the computer would send:

Header	Address	Instruction	Length	Process (n-1)	Layer (n-1)	Checksum
255 254	001	016	003	002	000 003	231

**10.8.12 Send a process list (Code #17)**

Instructs the controller to send all process names in the order that they are stored in the controller. The process list consists of 99 12 character process names.

Example: To instruct the controller to send the process list the computer would send:

Header	Address	Instruction	Length	Checksum
255 254	001	017	000	238

Since the 861's message length is limited to 249 bytes, the controller will send the process names in five separate messages. The first four messages will each contain 20 names and the last message will contain 19 names.

**10.8.13 Send controller status (Code #28)**

Instructs the controller to send the controller status data list. A description of the controller status data list is as follows:

Parameter Name	Length (bytes)	Range
Controller state	1	0 = Process ready 1 = Start layer 2 = Change pocket 3 = Change crystal 4 = Layer ready 5 = Soak rise 6 = Soak hold 7 = Rise to Predeposit 8 = Predeposit hold 9 = Establish rate 10 = Shutter Delay 11 = Deposit #1 12 = Rate ramp #1 13 = Deposit #2 14 = Rate ramp #2 15 = Deposit #3 16 = Rate ramp #3 17 = Deposit #4 18 = Rate ramp #4 19 = Deposit #5 20 = Ramp to feed 21 = Feed hold 22 = Ramp to idle 23 = Layer complete 24 = Process complete 25 = Process resume 26 = Initializing 27 = Set Soak Sweep 28 = Set Predeposit Sweep 29 = Set Deposit Sweep 30 = Set Feed Sweep
Abort Process Errors	1	bit 6 = Max Rate&Min Pwr bit 7 = Min Rate&Max Pwr
Alarm 1 Errors	1	bit 3 = Crystal Fail, Process Halted bit 4 = Rate Establish Error

Alarm 2 Errors	1	bit 3 = Sound Alarm Action bit 4 = Rate Deviation Alarm bit 5 = Crystal Fail, Time Power Mode bit 6 = Sensor Fault bit 7 = source fault
Alert Errors	1	bit 3 = Sound Alert Action bit 4 = Minimum Power Alert bit 5 = Maximum Power Alert bit 6 = Rate Deviation Alert bit 7 = Crystal Marginal
Attention 1 Errors	1	bit 0 = Process Complete bit 1 = Minimum Power Attention bit 2 = Maximum Power Attention bit 3 = Rate Deviation Attention bit 4 = Crystal Marginal&!In Process bit 5 = Crystal Fail&! In Process bit 6 = Crystal Marginal&In Process, Switch bit 7 = Crystal Fail&In Process, Switch
Attention 2 Errors	1	bit 3 = Manual Crystal Change bit 4 = Resume Process bit 5 = Sound Attention bit 6 = Manual Pocket Change bit 7 = Pause on Layer Complete
Discrete Input Register 1	1	bit 0 = Input #1, ...8 ( 0=False, 1=True)
Discrete Input Register 2	1	bit 0 = Input #9, ...16 ( 0=False, 1=True)
Discrete Output Register 1	1	bit 0 = Output #1, ...8 ( 0=False, 1=True)
Discrete Output Register 2	1	bit 0 = Output #9, ...16 ( 0=False, 1=True)
Controller Status 1	1	bit 0 = Ready Mode bit 1 = Manual Mode bit 2 = Time Power Mode bit 3 = Hold Mode bit 4 = Halt Mode bit 5 = Abort Mode bit 6 = Power Control Mode bit 7 = In Process
Controller Status 2	1	bit 0 = Resume Process bit 1 = Simulate Mode bit 5 = Material Time Setpoint bit 6 = Backup Sensor Active bit 7 = Last Layer Of Process
Source #1 Pocket Position	1	1-30
Source #2 Pocket Position	1	1-30
Source #3 Pocket Position	1	1-30
Source #4 Pocket Position	1	1-30
Not used	2	
Source #1 Power	2	0-4000, Power=99.9%*N/4000
Source #2 Power	2	0-4000, Power=99.9%*N/4000
Source #3 Power	2	0-4000, Power=99.9%*N/4000
Source #4 Power	2	0-4000, Power=99.9%*N/4000
Not used	4	
Sensor #1 Crystal Position	1	1-8
Sensor #2 Crystal Position	1	1-8
Sensor #3 Crystal Position	1	1-8

Sensor #4 Crystal Position	1	1-8
Not used	2	
Sensor #1 Crystal Health	1	0-99%
Sensor #2 Crystal Health	1	0-99%
Sensor #3 Crystal Health	1	0-99%
Sensor #4 Crystal Health	1	0-99%
Not used	2	
Total 43 bytes		

**Format:** Header, Address, Instruction=28, Length=0, Checksum

**Example:** To instruct the controller to send the controller status the computer would send:

Header	Address	Instruction	Length	Checksum
255 254	001	028	000	227

### 10.8.14 Start process (Code #29)

Instructs the controller to start the specified process from specified layer.

**Format:** Header, Address, Instruction=29, Length=3, Process #(0-98) 1byte, Starting layer #(1-999) 2 bytes, Checksum.

**Example:** To instruct the controller to start process # 5 on layer # 10 the computer would send:

Header	Address	Instruction	Length	Process (n-1)	Layer	Checksum
255 254	001	029	003	004	000 009	210

### 10.8.15 Send run-time values (Code #30)

Instructs the controller to send the run-time value list one time. A description of the run-time value list is as follows:

Value Name	Length (bytes)	Format	Units
Power	4	String	%
Thickness	5	String	KÅ
Deposition rate	4	String	Å/sec
Crystal health	2	String	%
Layer number	3	String	None
Rate deviation	4	String	%
Active process number	1	0-98 (n-1)	Process # 1-99
Active material number	1	0-98 (n-1)	Material # 1-99
Active source number	1	1-4	
Sensor #1 Rate	4	String	A/sec
Sensor #2 Rate	4	String	A/sec
Sensor #3 Rate	4	String	A/sec
Sensor #4 Rate	4	String	A/sec
Not used	8		
Sensor #1 Thickness	5	String	KA

Sensor #2 Thickness	5	String	KA
Sensor #3 Thickness	5	String	KA
Sensor #4 Thickness	5	String	KA
Not used	4		
Sensor #1 Crystal Position	1	1-8	
Sensor #2 Crystal Position	1	1-8	
Sensor #3 Crystal Position	1	1-8	
Sensor #4 Crystal Position	1	1-8	
Not used	2		
Sensor #1 Crystal Health	1	0-99	%
Sensor #2 Crystal Health	1	0-99	%
Sensor #3 Crystal Health	1	0-99	%
Sensor #4 Crystal Health	1	0-99	%
Not used	2		
Source #1 Pocket Position	1	1-30	
Source #2 Pocket Position	1	1-30	
Source #3 Pocket Position	1	1-30	
Source #4 Pocket Position	1	1-30	
Not used	2		
Layer Time to go	7	String	H:MM:SS
State Time to go	7	String	H:MM:SS
Elapsed Process Time	7	String	H:MM:SS
Elapsed Layer Time	7	String	H:MM:SS
Elapsed State Time	7	String	H:MM:SS
Source #1 Status	1	bit 0 = Shutter bit 1 = Rotator Drive Up bit 2 = Rotator Drive Down	
Source #2 Status	1		
Source #3 Status	1		
Source #4 Status	1		
Not used	2		
Sensor #1 Status	1	bit 0 = Shutter bit 1 = Rotator Drive Up bit 2 = Rotator Drive Down bit 3 = Enabled bit 5 = Failed	
Sensor #2 Status	1		
Sensor #3 Status	1		
Sensor #4 Status	1		
Not used	2		
Controller state	1	0 = Process ready 1 = Start layer 2 = Change pocket 3 = Change crystal 4 = Layer ready 5 = Soak rise 6 = Soak hold 7 = Rise to Predeposit 8 = Predeposit hold 9 = Establish rate 10 = Shutter Delay 11 = Deposit #1 12 = Rate ramp #1 13 = Deposit #2 14 = Rate ramp #2 15 = Deposit #3 16 = Rate ramp #3	



		17 = Deposit #4 18 = Rate ramp #4 19 = Deposit #5 20 = Ramp to feed 21 = Feed hold 22 = Ramp to idle 23 = Layer complete 24 = Process complete 25 = Process resume 26 = Initializing 27 = Set Soak Sweep 28 = Set Predeposit Sweep 29 = Set Deposit Sweep 30 = Set Feed Sweep	
Abort Process Errors	1	bit 6 = Max Rate&Min Pwr bit 7 = Min Rate&Max Pwr	
Alarm 1 Errors	1	bit 3 = Crystal Fail, Process Halted bit 4 = Rate Establish Error	
Alarm 2 Errors	1	bit 3 = Sound Alarm Action bit 4 = Rate Deviation Alarm bit 5 = Crystal Fail, Time Power Mode bit 6 = Sensor Fault bit 7 = source fault	
Alert Errors	1	bit 3 = Sound Alert Action bit 4 = Minimum Power Alert bit 5 = Maximum Power Alert bit 6 = Rate Deviation Alert bit 7 = Crystal Marginal	
Attention 1 Errors	1	bit 0 = Process Complete bit 1 = Minimum Power Attention bit 2 = Maximum Power Attention bit 3 = Rate Deviation Attention bit 4 = Crystal Marginal&!In Process bit 5 = Crystal Fail&! In Process bit 6 = Crystal Marginal&In Process, Switch bit 7 = Crystal Fail&In Process, Switch	
Attention 2 Errors	1	bit 3 = Manual Crystal Change bit 4 = Resume Process bit 5 = Sound Attention bit 6 = Manual Pocket Change bit 7 = Pause on Layer Complete	
Controller Status 1	1	bit 0 = Ready Mode bit 1 = Manual Mode bit 2 = Time Power Mode bit 3 = Hold Mode bit 4 = Halt Mode bit 5 = Abort Mode bit 6 = Power Control Mode bit 7 = In Process	
Controller Status 2	1	bit 0 = Resume Process bit 1 = Simulate Mode bit 5 = Material Time Setpoint bit 6 = Backup Sensor Active	

		bit 7 = Last Layer Of Process	
	Total 163 Bytes		

The string values are in ASCII format, including decimal points and colons.

Example: To instruct the controller to send the run-time value list the computer would send:

Header	Address	Instruction	Length	Checksum
255 254	001	030	000	225

### 10.8.16 Send Process Log Directory (Code #36)

Instructs the controller to send the process log directory to the host computer. The process log directory consists of 16 individual process logs. The data format of a process log is listed in the following table:

Parameter Name	Length (bytes)	RS-232 Range	Units
Process Log Name	12	All ASCII Characters	
Process Run Number	2	1-9999	
Starting Time	3	00:00:00-23:59:59	HH:MM:SS
Starting Date	3	01/01/00-12/31/99	MM:DD:YY
Completion Time	3	00:00:00-23:59:59	HH:MM:SS
Completion Status	1	0=Normal, 1=Aborted	
Data Points/Minute	1	38=30ppm, 39=60ppm, 40=120ppm, 41=300ppm, 42=600ppm, 255=other	
Starting Layer Number	2	0-999	Layer # 1-999
Ending Layer Number	2	0-999	Layer # 1-999
		Total 29 bytes	

Each byte in the time and date data is an integer value representing hour, minute, second, month, day, or year. The process run number and layer numbers are 2-byte integers.

If the first byte of the process name of any process log is equal to 255 then that log is considered blank.

Since the 861's message length is limited to 249 bytes, the controller will send the process log directory data in two separate 232 byte messages. The first message will contain the first eight logs and the second message will contain the last eight logs.

**Example:** To instruct the controller to send the process log directory the computer would send:

Header	Address	Instruction	Length	Checksum
255 254	001	036	000	219

### 10.8.17 Delete a material (Code #150)

Instructs the controller to delete requested material. Material number range #1-99 (byte 0-98)

**Example:** To instruct the controller to delete material# 16 the computer would send:

<b>Header</b>	<b>Address</b>	<b>Instruction</b>	<b>Length</b>	<b>Material (n-1)</b>	<b>Checksum</b>
255 254	001	150	001	015	089

# 11 ASCII SERIAL INTERFACE

---

## 11.1 GENERAL

---

The 861 comes standard with an RS-232 serial interface. The serial computer interface of the Telemark 861 Deposition Controllers permits remote control using a personal computer or process controller. The protocol is changed in the Utility menu under Serial Protocol.

There are four types of protocols: Standard, 360C, ASCII Checksum and ASCII No Checksum. This chapter deals with the ASCII Checksum and No Checksum protocols.

## 11.2 RS-232 SERIAL INTERFACE

---

The RS-232 serial interface of the 861 allows one 861 to be connected to any other device with an RS-232 serial interface. A D9P connector is provided on the rear panel for permanent connection to the host computer. See figure 3-5.

The 861 acts as DTE, and, accordingly, the 9-pin connector has 'plug' pins. It can be used with a DCE or a DTE host cable connection, provided the sense of the RxD/TxD data lines and the control lines is observed. Pin 2, 'TxD', transmits data from the 861 to the host; pin 3, 'RxD', receives data from the host. Pin 7, 'CTS', is a control output signal from the 861, and pin 8, 'RTS', is not used.

The 861 asserts pin 7 "CTS", when the host can transmit to the 861.

The 861's RS-232 port is automatically set up to operate with the following specifications:

8 Bit data, No Parity, 1 Stop bit

In the utility menu the baud rate is selectable 9600, 19200, 38400, 57600, or 115200.

The 861 will process a maximum of 20 RS-232 input messages a second.

## 11.3 ASCII PROTOCOL

---

All communications between the computer and the 861 are in ASCII code. All numbers are transmitted as numbers in ASCII code.

## 11.4 LIST OF COMMANDS

---

ASCII code			
Decimal Number	ASCII code	Command	Description
69	E	Echo	Returns the sent message
72	H	Hello	Returns the model and software version
81	Q	Query	Returns the values of requested film and layer parameters
85	U	Update	Replaces the particular film or layer parameter with the value sent
82	R	Remote action	Directs the 861 to perform an action
83	S	Status	Sends back requested information

## 11.5 ASCII CHECKSUM

---

ASCII code		
Decimal Number	ASCII code	Command
6	"ACK"	Command Acknowledgment (Control F on PC keyboards)
21	"NAK"	Negative Command Acknowledgement
2	"STX"	Start of transmission charter (Control B on PC keyboards)

**00,NN:** The size of the command is 2 bytes long, 00 represents the high order byte and the NN represents the low order byte.

**CS:** Checksum, modulo 256 value

Send to 861 format:

STX 00 NN "message string" CS

Reply from 861 format:

STX 00 NN ACK "message string" CS (success)

Or

STX 00 NN NAK "error code" CS (failure)

## 11.6 ASCII NO CHECKSUM

---

When sending commands to the 861, send "ACK" at the end of the message string. The 861 returns an "NAK" at the end of a response if the command failed and an "ACK" if the command succeeded.

**ASCII code**

<b>Decimal Number</b>	<b>ASCII code</b>	<b>Command</b>
<b>6</b>	<b>"ACK"</b>	Command Acknowledgment (Control F on PC keyboards)
<b>21</b>	<b>"NAK"</b>	Negative Command Acknowledgement

Send to 861 format:

"Message string" ACK

Reply from 861 format:

"Message string" ACK (success)

Or

"Error code" NAK (failure)

## 11.7 ERROR CODES

---

When the 861 fails to process or preform a command, it sends one of the following codes error code followed by a "NAK" (Negative Command Acknowledgement).

**ASCII code**

<b>Decimal Number</b>	<b>ASCII code</b>	<b>Description</b>
<b>65</b>	<b>A</b>	Illegal command
<b>66</b>	<b>B</b>	Illegal Value
<b>67</b>	<b>C</b>	Illegal Id
<b>68</b>	<b>D</b>	Illegal format
<b>69</b>	<b>E</b>	No data to get
<b>70</b>	<b>F</b>	Cannot change parameter at this time

## 11.8 DEBUG COMPUTER INTERFACE

---

From the Program menu select the Interface button to get to a screen that shows all the sent and received RS-232 data. This may be helpful debugging any problems interfacing the 861 to a computer or PLC. This display is meant for low frequency messaging debugging. Displayed are the decimal number of each byte.

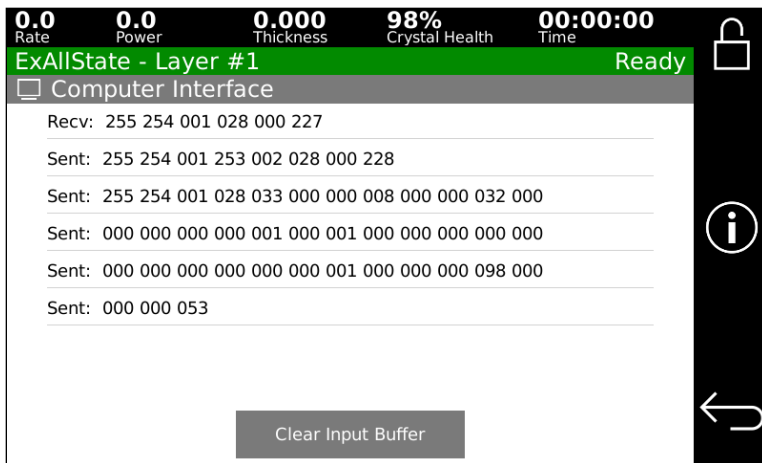

Figure 11-1, RS-232 Debug Computer Interface Screen

## 11.9 INSTRUCTION SUMMARY

To send a command to the 861 enter the ASCII command, any parameters. With a “space” (ASCII code Decimal Number 32) between the command and the parameters. Then the “ACK” (ASCII code Decimal Number 6) Command Acknowledgment (Control F on PC keyboards) to finish the command.

### 11.9.1 Echo

The echo command returns the message sent.

**Format:** E “message string”<ACK>

### 11.9.2 Hello

The hello command returns the model number and software version (example: “Telemark 861 Version 1.10.2”)

**Format:** H<ACK>

### 11.9.3 Query

The query command returns parameter information.

**Format:** Q “parameter number” “film number”<ACK>

**Example:** to see Deposition Rate of film 1 send: Q 16 1<ACK>

A material must first exist on the 861 before a Query or Update command can be sent to a material (film number) on the 861. An error will be sent if there is no material (film number). “The Feed Enabled” parameter in the material should be set to Disabled when using the ASCII serial interface.

Parameter Number	Parameter Name	Range	Units	Notes
0	Rise Time 1	00:00 to 99:59	Minutes:Seconds	“Update” excepts 00:00 to 99:59 (Minutes:Seconds) or 0-5999 seconds

1	Soak Power 1	0.0 to 100.0	%	
2	Soak Time 1	00:00 to 99:59	Minutes:Seconds	"Update" excepts 00:00 to 99:59 (Minutes:Seconds) or 0-5999 seconds
3	Rise to Predeposit Time (Rise Time 2)	00:00 to 99:59	Minutes:Seconds	"Update" excepts 00:00 to 99:59 (Minutes:Seconds) or 0-5999 seconds
4	Predeposit Power (Soak Power 2)	0.0 to 100.0	%	
5	Predeposit Time (Soak Time 2)	00:00 to 99:59	Minutes:Seconds	"Update" excepts 00:00 to 99:59 (Minutes:Seconds) or 0-5999 seconds
6				Not supported, returns 0
7	Deposition Rate 2 (New Rate)	0.0 to 999.9	Å/s	
8	Rate Ramp Time	00:00 to 99:59	Minutes:Seconds	The rate ramp time is loosely approximate, calculated from the 861's Start Thickness 1, Stop Thickness 1, Deposit Rate 1, and Deposit Rate 2, and will be less than the actual rate ramp time. The more responsive the PID parameters, the closer this value will be to the actual time. "Update" excepts 00:00 to 99:59 (Minutes:Seconds) or 0-5999 seconds
9	Idle Ramp	00:00 to 99:59	Minutes:Seconds	<b>Idle Ramp is set to the sum of the 861 Ramp to Feed, Feed, and Ramp to Idle times. Ramp to Feed and Feed state may be disabled in the material.</b> "Update" excepts 00:00 to 99:59 (Minutes:Seconds) or 0-5999 seconds
10	Idle Power	0.0 to 100.0	%	
11	Time Power (Crystal Fail)	Yes/No		Returns 1 if Crystal Fail is set to "Time Power," Returns 0 if Crystal Fail is set to "Switch" or "Halt."
12				Not supported, returns 0
13				Not supported, returns 0
14	Tool Factor 1	10.0 to 500.0	%	
15	Backup Tooling Factor (Tool Factor 2)	10.0 to 500.0	%	
16	Deposition Rate	0.0 to 999.9	Å/s	
17	Material Film Thickness (Final Thickness)	0.000 to 999.900	kÅ	
18	Rate Ramp Start 1 (Thickness Set Point)	0.000 to 999.900	kÅ	
19	Material Density	0.50 to 99.99		



20	Acoustic Impedance (Z-Ratio)	0.100 to 9.999		Auto conversion, Z = 8.83/AI
21	Sensor	1 to 4		
22	Source	1 to 4		
23	Pocket	1 to 30		Returns the pocket number, 1 - 30. Does not return 0 if single pocket.
24	Proportional Gain (Control Gain)	0.01 to 100.00	Å/s/%Power	Multiplies the 861 gain by (9999 / 100.0) before returning. "Update" clips incoming values outside the range to 0.1 or 100.0
25	Integral Time constant (Control TC)	0.1 to 99.9	Seconds	"Update" clips incoming values outside the range to 0.1 or 99.9
26	Derivative Time Constant (Control DT)	0.1 to 99.9	Seconds	"Update" clips incoming values outside the range to 0.1 or 99.9
27	Maximum Power	0.0 to 100.0	%	
28				Not supported, returns 0
29				Not supported, returns 0:00
40	Layer	0, 1-999		0 = the first three layers. If no layer data is found in the requested range, a "No Data" error is sent back.
99	All			Replies with all film parameters in order with a space between each one.

If a requested time is 99:59 seconds or less, it is expressed as MM:SS. Otherwise, it is expressed as HH:MM:SS

## 11.10 UPDATE

The update command sets parameters. See Query table for parameters.

**Format:** U "parameter number" "film number" "value"<ACK>

If "value" is left blank then a value of 0 will be accepted.

**Example:** to see Deposition Rate of film 1 send: U 16 1 44.4<ACK>

To set all parameters at one time use the "parameter number" 99. Each parameter must be separated by a space.

Notes for update command:

Parameter Number 40: Sets materials for the current loaded process. Must only refer to materials whose material names have already been programmed on the 861, as the 861 internally references materials based on name, not number. Names only need to be assigned once, and from then on, the materials may be accessed via number over RS232 (Note that names will be automatically assigned if a parameter is updated for a material

that does not yet have a name). The 861 does not allow blank layers in a process between two programmed layers, so the user could not set the material for layer 1 and 3 and leave the material for layer 2 blank; there would be an error when the process is run. If a layer is removed by setting its material number to 0, any following layers have their layer number reduced by 1 (since the 861 does not allow blank layers). The 861 does not allow a process's materials to be changed while it is running, changes made while running will be written to the disk for the next run but will not be applied until the next time the system goes to a ready state (after reset) or the process is run. If the 861 is running a FILM, only layer 1 may be updated.

Parameter Number 8: This may only be set after parameters 7, 16, and 18 are set. It will calculate and set a loosely approximate Rate Ramp Stop 1 parameter from the Rate Ramp Start 1, Deposition Rate 1, Deposition Rate 2, and the Rate Ramp Time. Setting the Rate Ramp Time to 0 causes the 861 to set Rate Ramp Stop 1 to Rate Ramp Start 1, regardless of any of the other parameter values.

Parameter Number 23: If 0, sets pocket to 1.

Parameter Number 25: If set greater than 99.9, sets Integral Time Constant to 99.9.

## 11.11 STATUS

The status command gets 861 status information.

**Format:** S "status code"<ACK>

**Example:** to see the status of the thickness send: S 3<ACK>

Status Code	Status Name	Range	Units	Notes
0	Process Info			All information from S1 to S10 separated by spaces
1	Rate	0.0 to 999.9	Å/s	Not averaged
2	Power	0.0 to 999.9	%	Not averaged
3	Thickness	0.0000 to 999.9999	kÅ	Not averaged
4	Process State			0 - Ready, Initializing, state unknown 1 - Start Process, Start Layer, Change Pocket, Change Crystal, Set Soak Sweep, Layer Ready 2 - Soak Rise 3 - Soak Hold 4 - Set Predeposit Sweep, Predeposit Rise 5 - Predeposit Hold 6 - Shutter Delay, Set Deposition Sweep, Establish Rate 7 - Deposit 1, Deposit 2, Deposit 3, Deposit 4, Deposit 5 8 - Rate ramp 1, Rate ramp 2, Rate ramp 3, Rate ramp 4 9 - Manual mode is enabled (takes precedence over all other states) 10 - Time power is in process (takes precedence over every other state, doesn't take precedence over manual mode). 11 - Ramp to Idle, Set Feed Sweep, Ramp to Feed, Feed

				12 - Layer Complete, Process Complete, Process Resume
5	Time to Go	00:00 to 99:59	MM:SS or HH:MM:SS	Returns the 861 time to go (in whatever way its been programmed on the 861: Estimated state, estimated layer, elapsed process, elapsed layer, elapsed state) If the requested time is 99:59 seconds or less, it is expressed as MM:SS. Otherwise, it is expressed as HH:MM:SS.
6	Active Layer	1 to 999		If the layer is 10 - 99, it is expressed as xx. If the layer is 100-999, it is expressed as xxx.
7	Active Film (Material)	1 to 99		If the film (material) is 1 - 9, it is expressed as x. If the film is 10 - 99, it is expressed as xx.
8	Active Sensor	1 to 4		
9	Crystal Life	0 to 99	%	If crystal health is greater than 99, sets to 99.
10	Source	1 to 4		
11	Output status			Returns only outputs 1 - 16. Since the 861 outputs are assignable to user-specified slot & pins, the 861 will need to be configured to obtain the desired behavior. If an output is not programmed, its value is returned as 0.
12	Input status			Returns only inputs 1 - 9. Just like the outputs, the 861 will need to have the inputs configured to obtain the desired behavior. If an input is not programmed, its value is returned as 0. Does not adjust for "True when High" setting.
13	Raw Frequency	xxxxxxx.x	Hz	Returns -----.- if frequency currently not being read.
14	Crystal Fail	1 = fail, 0 = ok		
15	Max Power	1 = max power, 0 = not		
16	Crystal Switching	1 = Crystal Switching, 0 = not		
17	End of process	1 = End of process, 0 = not		
18	Abort (stop)	1 = if in Aborted or Halted mode, 0 = not		
19				Not supported
20	Present Configuration			1 – Simulate mode 1 = on, 0 = off 2 – Lock 1 = on, 0 = off 3, 4, 5, 6, 7, 8 - Not supported and always set to 0 9 – Set to 1 if all forms of audio communication are enabled (touch, error beep, attention, alert, and alarm volumes all greater than 0) 10 – set to 1 if Brightness is less than High 11, 12, 13,14, 15 - not supported and always returns 0 16 - always set to 1, 861 always has positive voltage polarity.
21	Error Flag			Always returns 10.
22	same as S20			

30				Not supported
31	Rolling 3 sec. average of rate			Returns the averaged rate that is displayed on the 861.
32	Extended Process Info			All information from S1 to S10, S13, S14, S17, S18 separated by spaces

## 11.12 REMOTE

The remote command sends back the current value of a system status.

**Format:** R "remote code" "value"<ACK>

**Example:** to close relay 3 send: R 17 3<ACK>

Remote Code	Remote Name	Notes
0	Start	
1	Stop	
2	Reset	
3	Remote Lock on	Remote lock stops the parameters from being changed. The lock icon on the upper right-hand corner of the touch screen will have an "R" in it when in Remote lock mode. Remote lock is cleared when the 861 is rebooted.
4	Remote Lock off	Removes remote lock
5	Not supported	Not used, returns "A"
6	Not supported	
7	Soak Hold on	The 861 allows setting "Predeposit Hold" via RS232 only.
8	Soak Hold off	
9	Manual on	
10	Manual off	
11	Set power	If 861 is in "manual" mode the power can be set from 0 to 99%
12	Zero thickness	
13	Final thickness trigger	
14	Crystal switch	
15	Not supported	Not used, Returns ACK
16	Not supported	
17	Set digital output (Close relay 1-32)	xx may be from 1 - 32. The 861 will not allow the user to set an output that is reserved for a particular (Internally Defined) purpose or is programmed to be set via a condition. An output has to be programmed with card and pins selected for a relay to be set or cleared, otherwise, the command is ignored. If the user programs the conditions for an output that has been set using R17 or R18 since powerup, the 861 will retake control of that output until the next R17 or R18 command for that output.
18	Clear digital output (Open relay 1-32)	
19	Not supported	Not used, Returns ACK
20	Not supported	Not used, Returns ACK
21	Trigger beeper	861 plays "alert" sound when R21 sent. The sound is cleared by a reset or a screen touch, the same as other alerts.
22	Not supported	Not used, Returns ACK
23	Not supported	Not used, Returns ACK
24	Not supported	Not used, Returns ACK
25	Not supported	Not used, Returns ACK
30	Simulate Mode On	
31	Simulate Mode Off	
32	Not supported	Not used, Returns ACK
33	Not supported	Not used, returns "A"

34	Not supported	Not used, Returns ACK
35	Not supported	Not used, Returns ACK
36	Stop on max power	If "Stop on Max Power" is set, the 861 halts when the "Max Power Alert" condition occurs (as long as R37 was called before the Max Power Alert occurs). If the user wants the timing to be the same as the legacy controller, a material's Power Alarm Delay will need to be set to 5 sec.
37	No stop on max power	
38	Not supported	Not used, Returns ACK
39	Not supported	
40	Not supported	
41	Not supported	
42	Not supported	
43	Not supported	

## 12 MIXED ASCII INTERFACE

---

### 12.1 GENERAL

---

The 861 comes standard with an RS-232 serial interface. The serial computer interface of the Telemark 861 Deposition Controllers permits remote control using a personal computer or process controller. The protocol is changed in the Utility menu under Serial Protocol.

There are five types of protocols: Standard, 360C, ASCII Checksum, ASCII No Checksum and Mixed ASCII. This chapter deals with the Mixed ASCII protocol.

### 12.2 RS-232 SERIAL INTERFACE

---

The RS-232 serial interface of the 861 allows one 861 to be connected to any other device with an RS-232 serial interface. A D9P connector is provided on the rear panel for permanent connection to the host computer. See figure 3-5.

The 861 acts as DTE, and, accordingly, the 9-pin connector has 'plug' pins. It can be used with a DCE or a DTE host cable connection, provided the sense of the RxD/TxD data lines and the control lines is observed. Pin 2, 'TxD', transmits data from the 861 to the host; pin 3, 'RxD', receives data from the host. Pin 7, 'CTS', is a control output signal from the 861, and pin 8, 'RTS', is not used.

The 861 asserts pin 7 "CTS", when the host can transmit to the 861.

The 861's RS-232 port is automatically set up to operate with the following specifications:

8 Bit data, No Parity, 1 Stop bit

In the utility menu the baud rate is selectable 9600, 19200, 38400, 57600, or 115200.

The 861 will process a maximum of 20 RS-232 input messages a second.

### 12.3 MIXED ASCII PROTOCOL

---

All communications between the computer and the 861 are in ASCII code. All numbers are transmitted as numbers in ASCII code.

## 12.4 LIST OF COMMANDS

---

ASCII code			
Decimal Number	ASCII code	Command	Description
69	E	Echo	Returns the sent message
72	H	Hello	Returns the model and software version
81	Q	Query	Returns the values of requested film and layer parameters
85	U	Update	Replaces the particular film or layer parameter with the value sent
82	R	Remote action	Directs the 861 to perform an action
83	S	Status	Sends back requested information

For Codes Q and U there are sub commands

ASCII code			
Decimal Number	ASCII code	Command	Description
70	F	Film	
71	G	General	
73	I	Input	
78	N	Film Name	
79	O	Output	
80	P	Process	
84	T	Output Type	

## 12.5 ASCII CHECKSUM PROTOCOL

---

### 12.5.1 Send

**<length><message><checksum>**

**Length:** 2 bytes low/high (only the message) the number of characters in the command. Low byte is before the high byte.

**Message:** <command>..<command> One or more commands can be sent in a message

Command = Command (and sub command if needed), Parameter

**Checksum:** 1 byte, sum, modulo 256, of all bytes not including length

### 12.5.2 Response

**<length><CCB><timer><response message><checksum>**

**Length:** 2 bytes low/high (only the message) the number of characters in the command. Low byte is before the high byte.

**CCB:** Condition Code Byte = 1 byte binary (hex 80 = command error, hex00 = command valid)

**Timer:** 1 byte binary, number 0 to 255, changes every 0.25 second

**Response Message:** <command>..<command> One or more commands can be sent in a message

Command Response = <ACK><response>|<response error code>

<ACK> is hex value 6

Response = (<Integer>|<float>|<string>|<other>..<Integer>|<float>|<string>|<other>)

Integer = 4byte, low/high

Float = 4 byte, ansii standard, single precision, low to high

String = null terminated series of ascii characters

### 12.5.3 Error Codes

When the 861 fails to process or preform a command, it sends one of the following codes error code followed by a "NAK" (Negative Command Acknowledgement).

ASCII code		Description
Decimal Number	ASCII code	
65	A	Illegal command
66	B	Illegal Value
67	C	Illegal Id
68	D	Illegal format
69	E	No data to get
70	F	Cannot change parameter at this time
76	L	Error, length not 0 to 57,800
79	O	Not enough room for response

### 12.5.4 Packet Error codes

ASCII code		Description
Decimal Number	ASCII code	
67	C	Invalid checksum
70	F	Illegal format
73	I	Invalid message
76	L	Error, length not 0 to 57,800
77	M	Too many commands (more than 100)

**Checksum:** 1 byte, sum, modulo 256, of all bytes not including length

**Timeout:** If the time is more than 3 seconds between characters then the buffers are cleared and new characters are assumed to be a new command.



### 12.5.5 Debug Computer Interface

From the Program menu select the Interface button to get to a screen that shows all the sent and received RS-232 data. This may be helpful debugging any problems interfacing the 861 to a computer or PLC. This display is meant for low frequency messaging debugging. Displayed are the decimal number of each byte.

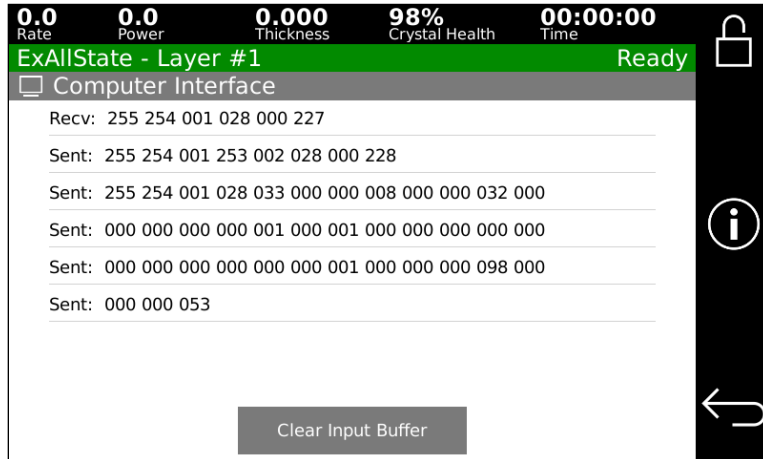

Figure 12-1, RS-232 Debug Computer Interface Screen

## 12.6 INSTRUCTION SUMMARY

---

Command types:

Integer = 4byte, low/high

Float = 4 byte, ansii standard, single precision, low to high

String = null terminated series of ascii characters

<NUL> = decimal 0

Following at the command part of the command packet

### Echo

---

The echo command returns the message sent.

**Format:** E "message string"<NUL>

**Response:** <string><NUL>

### Hello

---

The hello command returns the model number and software version (example: "Telemark 861 Version 1.10.2")

**Format:** H "Command ID"

**Response:** <string><NUL> or <float>

Standard Command ID	Meaning	Response
1	Ascii name/version	<string> = "Telemark 861 Version x.xx"
2	None	
3	None	

## Query

**Format:** QB, Query Block not supported.

**Format:** QG, Query General Parameter not supported.

Standard query film command returns parameter information.

**Format:** QF "Command ID" "film number"

**Example:** to see Deposition Rate of film 1 send: QF 8 1

A material must first exist on the 861 before a Query or Update command can be sent to a material (film number) on the 861. An error will be sent if there is no material (film number). "The Feed Enabled" parameter in the material should be set to Disabled when using the ASCII serial interface.

Parameter Number	Parameter Name	Range	Units	Data Type/Format	Notes
0	Rise Time 1	00:00 to 99:59	Minutes:Seconds	Int	"Update" excepts 00:00 to 99:59 (Minutes:Seconds) or 0-5999 seconds (5999)
1	Soak Power 1	0.0 to 100.0	%	Float xxx.x	
2	Soak Time 1	00:00 to 99:59	Minutes:Seconds	Int	"Update" excepts 00:00 to 99:59 (Minutes:Seconds) or 0-5999 seconds
3	Rise to Predeposit Time (Rise Time 2)	00:00 to 99:59	Minutes:Seconds	Int	"Update" excepts 00:00 to 99:59 (Minutes:Seconds) or 0-5999 seconds
4	Predeposit Power (Soak Power 2)	0.0 to 100.0	%	Float xxx.x	
5	Predeposit Time (Soak Time 2)	00:00 to 99:59	Minutes:Seconds	Int	"Update" excepts 00:00 to 99:59 (Minutes:Seconds) or 0-5999 seconds
6	Idle Ramp	00:00 to 99:59	Minutes:Seconds	Int	<b>Idle Ramp is set to the sum of the 861 Ramp to Feed, Feed, and Ramp to Idle times. Ramp to Feed and Feed state may be disabled in the material.</b> "Update" excepts 00:00 to 99:59 (Minutes:Seconds) or 0-5999 seconds
7	Idle Power	0.0 to 100.0	%	Float xxx.x	
8	Deposition Rate	0.0 to 999.9	Å/s	Float	

				xxx.x	
9	Material Film Thickness (Final Thickness)	0.000 to 999.900	kÅ	Float x.xxx xx.xx xxx.x	
10	Rate Ramp Start 1 (Thickness Set Point)	0.000 to 999.900	kÅ	Float x.xxx xx.xx xxx.x	Rate Ramp (Thickness K Å) must be enabled in material.
11	Deposition Rate 2 (New Rate)	0.0 to 999.9	Å/s	Float xxx.x	Rate Ramp (Thickness K Å) must be enabled in material.
12	Rate Ramp Time	00:00 to 99:59	Minutes:Seconds	Int	Rate Ramp (Thickness K Å) must be enabled in material. The rate ramp time is loosely approximate, calculated from the 861's Start Thickness 1, Stop Thickness 1, Deposit Rate 1, and Deposit Rate 2, and will be less than the actual rate ramp time. The more responsive the PID parameters, the closer this value will be to the actual time. "Update" excepts 00:00 to 99:59 (Minutes:Seconds) or 0-5999 seconds
13					Not supported
14					Not supported
15	Sensor	1 to 4		Int	
16	Tool Factor 1	10.0 to 500.0	%	Float xxx.x	
17	Backup Tooling Factor (Tool Factor 2)	10.0 to 500.0	%	Float xxx.x	
18					Not supported
19					Not supported
20					Not supported
21					Not supported
22	Source	1 to 4		Int	
23	Pocket	1 to 30		Int	Returns the pocket number, 1 - 30. Does not return 0 if single pocket.
24	Proportional Gain (Control Gain)	0.01 to 100.00	Å/s/%Power	Float	Multiplies the 861 gain by (9999 / 100.0) before returning. "Update"

				xx.xx	clips incoming values outside the range to 0.1 or 100.0
25	Integral Time constant (Control TC)	0.1 to 99.9	Seconds	Float xxx.x	"Update" clips incoming values outside the range to 0.1 or 99.9
26	Derivative Time Constant (Control DT)	0.1 to 99.9	Seconds	Float xxx.x	"Update" clips incoming values outside the range to 0.1 or 99.9
27	Maximum Power	0.0 to 100.0	%	Float xxx.x	
28	Material Density	0.50 to 99.99		Float x.xx xx.xx	
29	Acoustic Impedance (Z-Ratio)	0.100 to 9.999		Float x.xxx xx.xx xxx.x	Auto conversion, Z = 8.83/AI
30	Time Power (Crystal Fail)	Yes/No		Int	Returns 1 if Crystal Fail is set to "Time Power," Returns 0 if Crystal Fail is set to "Switch" or "Halt."
31	Delay option			Int	0 = None 1 = Shutter 2 and 3 Not supported If 1, then the 861 will set the rate establish error to 5%
32					Not supported
33					Not supported
34					Not supported
35					Not supported
36					Not supported
37					Not supported
255	All				Replies with all film parameters in order with a space between each one.

255 gets all supported parameters and four 0s as placeholders for each unsupported parameter.

## 12.7 UPDATE

The update command sets parameters. See Query table for parameters.

**Format:** UF “command ID” “film number” “parameter value”

**Example:** to see Deposition Rate of film 1 send: UF 1

To set all parameters at one time use the “parameter number” 99. Each parameter must be separated by a space.

Notes for update command:

Parameter Number 16: This may only be set after parameters 11, 8, and 10 are set. It will calculate and set a loosely approximate Rate Ramp Stop 1 parameter from the Rate Ramp Start 1, Deposition Rate 1, Deposition Rate 2, and the Rate Ramp Time. Setting the Rate Ramp Time to 0 causes the 861 to set Rate Ramp Stop 1 to Rate Ramp Start 1, regardless of any of the other parameter values.

Parameter Number 23: If 0, sets pocket to 1.

Parameter Number 25: If set greater than 99.9, sets Integral Time Constant to 99.9.

## 12.8 STATUS

The status command gets 861 status information.

**Format:** S “status code”

**Example:** to see the status of the thickness send: S 3

Status Code	Status Name	Range	Units	Notes
0	Process Info			<p>Returns current information regardless of the timer tick requested, as the 861 does not keep a history of that information.</p> <p>Returns the following:</p> <p><b>Crystal Status</b> (1 byte)                      Bit 0 – 0 = Good, 1 = Failed Crystal                      Bit 1 – 0 = Not Switching, 1 = Switching crystal                      Bit 2 – 0 = Good reading, 1 = Invalid Reading</p> <p><b>State</b> (1 byte)  <b>Active Sensor</b> (1 byte)  <b>Active Crystal</b> (1 byte)  <b>Rate*</b> (Float)  <b>Thickness</b> (Float)  <b>Power</b> (Float)  <b>Rate Deviation*</b> (Float)  <b>Frequency</b> (Int DDS units) Multiply by 0.0034924596 to get Hz.</p> <p>* If in Stop or not in Deposit, Rate and Rate Deviation return values of zero.</p>

1	Rate	0.0 to 999.9	(Float) Å/s	Not averaged
2	Power	0.0 to 999.9	(Float) %	Not averaged
3	Thickness	0.0000 to 999.9999	(Float) kÅ	Not averaged
4	Process State		(Byte)	<p>0 - Ready, Initializing, state unknown</p> <p>1 - Start Process, Start Layer, Change Pocket, Change Crystal, Set Soak Sweep, Layer Ready</p> <p>2 - Soak Rise</p> <p>3 - Soak Hold</p> <p>4 - Set Predeposit Sweep, Predeposit Rise</p> <p>5 - Predeposit Hold</p> <p>6 - Shutter Delay, Set Deposition Sweep, Establish Rate</p> <p>7 - Deposit 1, Deposit 2, Deposit 3, Deposit 4, Deposit 5</p> <p>8 - Rate ramp 1, Rate ramp 2, Rate ramp 3, Rate ramp 4</p> <p>9 - Manual mode is enabled (takes precedence over all other states)</p> <p>10 - Time power is in process (takes precedence over every other state, doesn't take precedence over manual mode).</p> <p>11 - Ramp to Idle, Set Feed Sweep, Ramp to Feed, Feed</p> <p>12 - Layer Complete, Process Complete, Process Resume</p>
5	Time to Go	00:00 to 99:59	(Int) seconds	Returns the 861 time to go (in whatever way its been programmed on the 861: Estimated state, estimated layer, elapsed process, elapsed layer, elapsed state)
6	Active Layer	1 to 999	(Int)	If the layer is 10 - 99, it is expressed as xx. If the layer is 100-999, it is expressed as xxx.
7	Active Film (Material)	1 to 99	(Byte)	If the film (material) is 1 - 9, it is expressed as x. If the film is 10 - 99, it is expressed as xx.
8	Active Sensor	1 to 4	(Byte)	
9	Crystal Life	0 to 99	(Byte) %	If crystal health is greater than 99, sets to 99.
10	Source	1 to 4	(Byte)	
11	Output status		(4 Byte)	Returns only outputs 1 - 32. Since the 861 outputs are assignable to user-specified slot & pins, the 861 will need to be configured to obtain the desired behavior. If an output is not programmed, its value is returned as 0.
12	Input status		(2 Byte)	Returns only inputs 1 - 16. Just like the outputs, the 861 will need to have the inputs configured to obtain the desired behavior. If an input is not programmed, its value is returned as 0. Does not adjust for "True when High" setting.
13	Raw Frequency	xxxxxxx.x	(Int DDS units)	Multiply by 0.0034924596 to get Hz.
14	Crystal Fail	1 = fail, 0 = ok	(Byte)	
15	Max Power	1 = max power, 0 = not	(Byte)	

16	Crystal Switching	1 = Crystal Switching, 0 = not	(Byte)	
17	End of process	1 = End of process, 0 = not	(Byte)	
18	Abort (stop)	1 = if in Aborted or Halted mode, 0 = not	(Byte)	
19				Not supported
20	Present Configuration		(Byte)	1 – Simulate mode 1 = on, 0 = off 2 – Lock 1 = on, 0 = off 3, 4, 5, 6, 7, 8 - Not supported and always set to 0 9 – Set to 1 if all forms of audio communication are enabled (touch, error beep, attention, alert, and alarm volumes all greater than 0) 10 – set to 1 if Brightness is less than High 11, 12, 13,14, 15 - not supported and always returns 0 16 - always set to 1, 861 always has positive voltage polarity.
21	Error Flag		(Byte)	Always returns 0.
30				Not supported
31	Rolling 3 sec. average of rate		(Byte)	Returns the averaged rate that is displayed on the 861. (3 seconds)
32	Active Crystal		(Byte)	Crystal of the current sensor that is in use.
33	Status Messages		(4 Bytes)	returns status bits for Max Power, Crystal Fail, Crystal Switching, End of Process, 0x80 00 00 00 = Max Power 0x40 00 00 00 = Crystal Fail 0x10 00 00 00 = Crystal Switching 0x00 80 00 00 = End of Process 0x00 04 00 00 = Soak or Predeposit Hold 0x00 00 20 00 = Crystal Simulation Mode
34	Raw Rate		(Float) Å/s	Rate
35				Not supported

## 12.9 REMOTE

The remote command sends back the current value of a system status.

**Format:** R “remote code” “value”

**Example:** to close relay 3 send: R 17 3

Remote Code	Remote Name	Notes
0	Start	

1	Stop	
2	Reset	
3	Remote Lock on	Remote lock stops the parameters from being changed. The lock icon on the upper right-hand corner of the touch screen will have an "R" in it when in Remote lock mode. Remote lock is cleared when the 861 is rebooted.
4	Remote Lock off	Removes remote lock
5	Not supported	
6	Not supported	
7	Soak Hold on	The 861 allows setting "Predeposit Hold" via RS232 only.
8	Soak Hold off	
9	Manual on	
10	Manual off	
11	Set power	If 861 is in "manual" mode the power can be set from 0 to 99%. <Float>
12	Zero thickness	
13	Final thickness trigger	
14	Crystal switch	
15	Not supported	
16	Not supported	
17	Set digital output (Close relay 1-32)	xx may be from 1 - 32. The 861 will not allow the user to set an output that is reserved for a particular (Internally Defined) purpose or is programmed to be set via a condition. An output has to be programmed with card and pins selected for a relay to be set or cleared, otherwise, the command is ignored. If the user programs the conditions for an output that has been set using R17 or R18 since powerup, the 861 will retake control of that output until the next R17 or R18 command for that output.
18	Clear digital output (Open relay 1-32)	
19	Not supported	
20	Not supported	
21	Trigger beeper	861 plays "alert" sound when R21 sent. The sound is cleared by a reset or a screen touch, the same as other alerts.
22	Not supported	
26	Not supported	
27	Not supported	
28	Not supported	



## 13 TROUBLE SHOOTING

Symptom	Possible Cause
Unit blows line fuse.	a) Incorrect fuse size. b) Shorted transformer or filter capacitor.
Front Panel display never illuminates.	a) Blown fuse.
“Crystal Failure” message flashes with selected sensor properly connected.	a) Defective cable or cables. b) Defective or overloaded sensor crystal. c) Bad Oscillator unit.
No control voltage while monitoring output of selected Source/Sensor bd.	a) Cable/connector miswired or shorted. (Source/Sensor board) b) Bad Source/Sensor board.
Unit does not retain programmed data in memory.	a) Bad Main Processor board.
The unit fails to activate externally controlled devices (Shutters, solenoids, etc.)	a) Faulty Relay (Discrete I/O board) b) Bad Discrete I/O board.
Unable to remotely control the unit via Discrete I/O inputs.	a) Improperly wired cable/connector. b) Inputs not properly grounded. c) Bad Discrete I/O board.
Unable to manually control the source power through the Remote Power Handset.	a) Controller is not in Manual mode. b) Controller is in Abort mode. c) Faulty Remote Power Handset. d) Bad connection from the Manual Control connector to the Main bd.

## 14 MATERIAL TABLE

Element	Symbol	Melting Point (C°)	Bulk Density, g/cm <sup>3</sup>	Acoustic Impedance g/cm <sup>2</sup>	Acoustic Impedance Ratio (z)	Recommended Crucible Liner(s)	Sweep	Remarks
Aluminum	Al	660	2.700	8.170	1.081	Re-infiltrated	none	Alloys and wets tungsten; stranded superior.
Aluminum Antimonide	AlSb	1080	4.300	8.830	1.000			
Aluminum Arsenide	AlAs	1600	3.700	8.830	1.000			
Aluminum Bromide	AlBr <sub>3</sub>	97	2.640	8.830	1.000	Graphite		
Aluminum Carbide	Al <sub>4</sub> C <sub>3</sub>	2100	2.360	8.830	1.000			Sublimes.
Aluminum Floride	AlF <sub>3</sub>	2191	2.880	8.830	1.000	Graphite		Sublimes.
Aluminum Nitride	AlN	2200	3.260	8.830	1.000			Decomposes. Reactive evap Al in 10 <sup>3</sup> N <sub>2</sub> with glow discharge.
Aluminum Oxide (Alumina)	Al <sub>2</sub> O <sub>3</sub>	2045	3.970	26.280	0.336	Graphite, Re-infiltrated, Mo	large	
Aluminum Phosphide	AlP	2000	2.420	8.830	1.000			
Antimony	Sb	631	6.620	11.490	0.768			Toxic. Film structure is rate dependent Use Mo E.B. Liner.
Antimony Oxide	Sb <sub>2</sub> O <sub>3</sub>	656	5.820	8.830	1.000	BN, Al <sub>2</sub> O <sub>3</sub>		Toxic. Sublimes. Decomposes on W. Use low rate. Z. Physik 165,202 (1961).
Antimony Selenide	Sb <sub>2</sub> Se <sub>3</sub>	629	6.500	4.722	1.870	Carbon		Toxic. Stoichiometry variable.
Antimony Sulfide	Sb <sub>2</sub> S <sub>3</sub>	550	4.120	8.830	1.000	Al <sub>2</sub> O <sub>3</sub>		Toxic. No decomposition.

Antimony Telluride	Sb <sub>2</sub> Te <sub>3</sub>	629	6.500	8.830	1.000	Carbon		Toxic. Deomposes over 750 °C.
Arsenic	As	814	5.730	9.140	0.966	Al <sub>2</sub> O <sub>3</sub> , BeO, Vit Carbon		Toxic. Sublimes rapidly at low temperature.
Arsenic Selenide	As <sub>2</sub> Se <sub>3</sub>	360	4.750	8.830	1.000	Al <sub>2</sub> O <sub>3</sub> , Quartz		
Arsenic Sulfide	AS <sub>2</sub> S <sub>3</sub>	300	3.430	8.830	1.000	Mo		
Arsenic Telluride	AS <sub>2</sub> Te <sub>3</sub>	362	5.000	8.830	1.000			
Barium	Ba	725	3.500	4.200	2.102			Toxic. Wets w/o alloying, reacts with ceramics.
Barium Chloride	BaCl <sub>2</sub>	961	3.860	8.830	1.000			Use gentle preheat to outgas.
Barium Fluoride	BAF <sub>2</sub>	1280	4.890	9.811	0.900			Sublimes. Denisty rate dependent.
Barium Oxide	BaO	1923	5.720	8.830	1.000	Al <sub>2</sub> O <sub>3</sub>		Decomposes slightly.
Barium Sulfide	BaS	1200	4.250	8.830	1.000			Sublimes.
Barium Titanate	BaTiO <sub>3</sub>	1620	5.850	27.594	0.320			Decomposes, yields free Ba; sputter or coevaporate.
Beryllium	Be	1283	1.850	16.260	0.543	Vitreous carbon		Powder very toxic. Wets W/Mo/Ta.
Beryllium Chloride	BeCl <sub>2</sub>	440	1.900	8.830	1.000			Very Toxic.
Beryllium Fluoride	BeF <sub>2</sub>	800	1.990	8.830	1.000			Very Toxic, sublimes.
Beryllium Oxide	BeO	2575	3.010	8.830	1.000		large	Powder very toxic. No decomposition from EB.
Bismuth	Bi	271	9.800	11.180	0.790	Al <sub>2</sub> O <sub>3</sub> , Vit Carbon		Vapors are toxic. High resistivity.
Bismuth Fluoride	BiF <sub>3</sub>	727	5.320	8.830	1.000	Graphite		Toxic, sublimes. App. Opt. 18,105 (1979).
Bismuth Oxide	Bi <sub>2</sub> O <sub>3</sub>	811	8.900	8.830	1.000			Vapors are toxic.JVST 12, 63 (1975).
Bismuth Sulfide	Bi <sub>2</sub> S <sub>3</sub>	685	7.390	8.830	1.000			Toxic.
Bismuth Titanate	Bi <sub>2</sub> Ti <sub>2</sub> O <sub>7</sub>	875	9.030	8.830	1.000			Toxic. Deomposes. Sputter or coevaporate in 10 <sup>2</sup> O <sub>2</sub> .
Boron	B	2100	2.540	22.700	0.389	Vitreous carbon		Material explodes with rapid cooling.
Boron Carbide	B <sub>4</sub> C	2350	2.520	8.830	1.000			Similar to chromium.
Boron Oxide	B <sub>2</sub> O <sub>3</sub>	460	2.460	8.830	1.000			
Boron Sulfide	B <sub>2</sub> S <sub>3</sub>	310	1.550	8.830	1.000	Graphite		
Cadmium	Cd	321	8.640	12.950	0.682	Al <sub>2</sub> O <sub>3</sub> Quartz		Poisons vacuum systems, low sticking

								coefficient. Use MO E.B. Liner.
Cadmium Antimonide	CdSb	456	6.920	8.830	1.000			
Cadmium Arsenide	Cd <sub>3</sub> As <sub>2</sub>	721	6.210	8.830	1.000	Quartz		Toxic.
Cadmium Bromide	CdBr <sub>2</sub>	567	5.190	8.830	1.000			Sublimes.
Cadmium Chloride	CdCl <sub>2</sub>	960	4.050	8.830	1.000			Sublimes.
Cadmium Fluoride	CdF <sub>2</sub>	1100	6.640	8.830	1.000			
Cadmium Iodide	CdI <sub>2</sub>	387	5.670	8.830	1.000			
Cadmium Oxide	CdO	1430	8.150	8.830	1.000			Disproportionates.
Cadmium Selenide	CdSe	1351	5.790	8.830	1.000	Al <sub>2</sub> O <sub>3</sub>	large	Toxic, sublimes.
Cadmium Sulfide	CdS	1750	4.830	8.660	1.020			Sublimes. Sticking coeff. Affected by sub temp. Comp. variable JVST 12,188 (1975).
Cadmium Telluride	CdTe	1041	5.850	9.010	0.980			Toxic. Stoichiometry depends on substrate temp. JVST 8,412 (1971).
Calcium	Ca	845	1.550	3.370	2.620	Al <sub>2</sub> O <sub>3</sub> Quartz		Flammable, sublimes. Corrodes in air. Optic 18,59 (1961).
Calcium Fluoride	CaF <sub>2</sub>	1360	3.180	11.390	0.775	Quartz		Rate control important. Use gentle preheat to Outgas.
Calcium Oxide	CaO	2580	3.340	8.830	1.000	ZrO <sub>2</sub>		Forms volatile oxides with W and MO.
Calcium Silicate	CaO SiO <sub>2</sub>	1540	2.900	8.830	1.000	Quartz		
Calcium Sulfide	CaS	Subl.	2.500	8.830	1.000			Decomposes.
Calcium Tungstate	CaWO <sub>4</sub>	1620	6.060	8.830	1.000			
Carbon (Diamond)	C	3727	3.520	40.140	0.220		large	
Carbon (Graphite)	C		2.250	2.710	3.258			Sublimes. EB preferred, Arc evaporat. Poor film adhesion.
Cerium	Ce	795	6.670	10.267	0.860	Al <sub>2</sub> O <sub>3</sub> , BeO, Vit Carbon		Films oxidize easily.
Cerium (III) Fluoride	CeF <sub>3</sub>	1460	6.160	8.830	1.000			Use gentle preheat to outgas.

Cerium (IV) Oxide	CeO <sub>2</sub>	2600	7.130	8.830	1.000			Sublimes. Use 250°C sub. Temp. Reacts with W. J Opt Soc Am 48,324 (1958).
Cerium Oxide	Ce <sub>2</sub> O <sub>3</sub>	1691	6.890	21.537	0.410			Alloys with source. J. Opt. Soc. Am 48,324 (1958).
Cesium	Cs	29	1.890	8.830	1.000	Quartz		Flammable.
Cesium Bromide	CsBr	636	4.440	5.134	1.720			
Cesium Chloride	CsCl	646	3.990	8.830	1.000			Hygroscopic.
Cesium Fluoride	CsF	626	4.110	8.830	1.000			
Cesium Hydrozide	CsOH	272	3.670	8.830	1.000			
Cesium Iodide	CsI	621	4.510	2.993	2.950	Pt. Quartz		
Chromium	Cr	1875	7.200	28.950	0.305	Re-infiltrated, Vitreous carbon	large	Sublimes. High rates possible.
Chromium Boride	CrB	2760	6.170	8.830	1.000			
Chromium Bromide	CrBr <sub>2</sub>	842	4.360	8.830	1.000			
Chromium Chloride	CrCl <sub>2</sub>	824	2.880	8.830	1.000			Sublimes easily.
Chromium Oxide	Cr <sub>2</sub> O <sub>3</sub>	2435	5.210	8.830	1.000			Disproportionates to lower oxides, reoxidizes @ 600°C in air.
Chromium Sillicide	Cr <sub>3</sub> Si <sub>2</sub>	1710	6.510	8.830	1.000			
Chromium Carbide	Cr <sub>3</sub> C <sub>2</sub>	1890	6.680	8.830	1.000			
Cobalt	Co	1495	8.710	25.740	0.343	Al <sub>2</sub> O <sub>3</sub>	medium	Alloys with refractory metals.
Cobalt Bromide	CoBr <sub>2</sub>	678	4.910	8.830	1.000			Sublimes.
Cobalt Chloride	CoCl <sub>2</sub>	724	3.370	8.830	1.000			Sublimes.
Copper	Cu	1083	8.930	20.210	0.437	Graphite, Re-infiltrated	none or small	Films do not adhere well. Use intermediate Cr layer, O <sub>2</sub> free Cu req'd.
Copper (I) Sulfide (alpha)	Cu <sub>2</sub> S	1130	5.600	12.800	0.690			
Copper (I) Sulfide (beta)	Cu <sub>2</sub> S		5.800	13.180	0.670			
Copper (II) Sulfide	CuS	1113	4.600	10.770	0.820			Sublimes.
Copper Chloride	CuCl	431	4.190	8.830	1.000			
Copper Oxide	Cu <sub>2</sub> O	1235	6.000	8.830	1.000	Al <sub>2</sub> O <sub>3</sub>		Sublimes. Evaporate in 10 <sup>2</sup>

								to 10 <sup>4</sup> of O <sub>2</sub> ; J. Electrochem. Soc. 110,119 (1967).
Cryolite	Na <sub>3</sub> AlF <sub>6</sub>	1000	2.900	8.830	1.000	Vit. Carbon		Large chunks reduce spitting. Little decomposition. App. Opt. 15, 1969 (1976).
Dysprosium	Dy	1407	8.540	14.720	0.600			Flammable.
Dysprosium Oxide	Dy <sub>2</sub> O <sub>3</sub>	2340	7.810	8.830	1.000			Loses oxygen.
Erbium	Er	1461	9.050	11.930	0.740			Sublimes.
Erbium Fluoride	ErF <sub>3</sub>	1350	7.810	8.830	1.000			JVST A3 (6), 2320.
Erbium Oxide	Er <sub>2</sub> O <sub>3</sub>	2400	8.640	8.830	1.000			Loses oxygen.
Europium	Eu	826	5.244	8.830	1.000	Al <sub>2</sub> O <sub>3</sub>		Flammable, sublimes. Low tantalum solubility.
Europium Fluoride	EuF <sub>2</sub>	1390	6.500	8.830	1.000			
Europium Oxide	Eu <sub>2</sub> O <sub>3</sub>	2056	7.420	8.830	1.000	ThO <sub>2</sub>		Loses Oxygen; films clear and hard.
Europium Sulfide	EuS		5.750	8.830	1.000			
Gadolinium	Gd	1312	7.890	13.180	0.670	Al <sub>2</sub> O <sub>3</sub>		High Ta solubility. Flammable.
Gadolinium Oxide	Gd <sub>2</sub> O <sub>3</sub>	2310	7.410	8.830	1.000			Loses oxygen.
Gallium	Ga	30	5.930	14.890	0.593	Al <sub>2</sub> O <sub>3</sub>		Alloys with refractory metals. Use EB gun.
Gallium Antimonide	GaSb	710	5.600	8.830	1.000			Flash evaporate.
Gallium Arsenide	GaAs	1238	5.310	5.550	1.591	Carbon		Flash evaporate.
Gallium Nitride	GaN	800	6.100	8.830	1.000	Al <sub>2</sub> O <sub>3</sub>		Sublimes. Evaporate Ga in 10 <sup>3</sup> N <sub>2</sub> .
Gallium Oxide (β)	Ga <sub>2</sub> O <sub>3</sub>	1900	5.880	8.830	1.000			Loses oxygen.
Gallium Phosphide	GaP	1348	4.100	8.830	1.000	Quartz		Decomposes. Vapor mostly P.
Germanium	Ge	937	5.350	17.110	0.516	Re-infiltrated Al <sub>2</sub> O <sub>3</sub>	medium	
Germanium Oxide	GeO <sub>2</sub>	1086	6.240	8.830	1.000	Al <sub>2</sub> O <sub>3</sub>		Similar to SiO, film predominately GeO.
Germanium Telluride	GeTe	725	6.200	8.830	1.000	Quartz, Al <sub>2</sub> O <sub>3</sub>		
Glass, Schott 8329	-		2.200	8.830	1.000			Evaporable alkali glass. Melt in air before evaporating.

Gold	Au	1962	19.300	23.180	0.381	Re-infiltrated Mo, W	none or small	
Hafnium	Hf	2222	13.090	24.530	0.360		medium	
Hafnium Boride	HfB <sub>2</sub>	3250	10.500	8.830	1.000			
Hafnium Carbide	HfC	3890	12.200	8.830	1.000			Sublimes.
Hafnium Nitride	HfN	3305	13.800	8.830	1.000			
Hafnium Oxide	HfO <sub>2</sub>	2811	9.690	8.830	1.000	Mo, Re-infiltrated	large	Film HfO. App. Opt. Apr. 1977.
Hafnium Silicide	HfSi <sub>2</sub>	1680	8.020	8.830	1.000			
Holmium	Ho	1461	8.800	15.200	0.581			Sublimes.
Holmium Fluoride	HoF <sub>3</sub>	1143	7.640	8.830	1.000	Quartz		
Holmium Oxide	Ho <sub>2</sub> O <sub>3</sub>	2360	8.360	8.830	1.000			Loses Oxygen. App. Opt. 16,439.
inconel	Ni/Cr/Fe	1425	8.500	26.758	0.330			Use fine wire prewrapped on W. Low rate req'd for smooth films.
Indium	In	157	7.310	10.510	0.840	Mo, Graphite	small	Wets W and Cu
Indium (I) Sulfide	In <sub>2</sub> S	653	5.870	8.830	1.000	Graphite		
Indium (III) Sulfide	In <sub>2</sub> S <sub>3</sub>	1050	4.450	8.830	1.000	Graphite		Sublimes. Film In <sub>2</sub> S.
Indium Antimonide	InSb	535	5.760	11.480	0.769			Toxic. Decomposes; sputter preferred; or coevaporate from 2 sources; flash.
Indium Oxide	In <sub>2</sub> O <sub>3</sub>	1565	7.180	8.830	1.000	Al <sub>2</sub> O <sub>3</sub>	large	Sublimes
Indium Phosphide	InP	1071	4.900	8.830	1.000	Graphite		Deposits P rich. Flash evaporate.
Indium Selenide	In <sub>2</sub> Se <sub>3</sub>	890	5.670	8.830	1.000			Sputter, coevaporate or flash.
Indium Telluride	In <sub>2</sub> Te <sub>3</sub>	667	5.800	8.830	1.000			Sputter, coevaporate or flash.
Indium Tin Oxide	IN203-SnO <sub>2</sub>	1526	6.430	8.830	1.000			
Iridium	Ir	2454	22.400	68.450	0.129			
Iron	Fe	1536	7.860	25.300	0.349	Al <sub>2</sub> O <sub>3</sub>	medium	Attacks W. Films hard, smooth. Use gentle preheat to outgas.
Iron (III) Oxide	Fe <sub>2</sub> O <sub>3</sub>	1538	5.180	8.830	1.000			Disproportionates to Fe <sub>3</sub> O <sub>4</sub> at 1530°C.
Iron Bromide	FeBr <sub>2</sub>	684	4.640	8.830	1.000	Fe		
Iron Chloride	FeCl <sub>2</sub>	674	3.160	8.830	1.000	Fe		Sublimes.

Iron Iodide	FeI <sub>2</sub>	592	5.310	8.830	1.000	Fe		
Iron Sulfide	FeS	1195	4.740	8.830	1.000	Al <sub>2</sub> O <sub>3</sub>		Decomposes.
Lanthanum Boride	LaB <sub>6</sub>	2210	2.610	8.830	1.000			Toxic.
Lanthanum Fluoride	LaF <sub>3</sub>	1491	5.990	8.830	1.000			Sublimes. NO decomposition. Heat substrate over 300°C.
Lanthanum Oxide	La <sub>2</sub> O <sub>3</sub>	2315	6.510	8.830	1.000			Loses Oxygen.
Lanthanum	La	920	6.170	9.590	0.921	Al <sub>2</sub> O <sub>3</sub>		Films will burn in air if scraped.
Lead	Pb	327	11.300	7.810	1.131	Al <sub>2</sub> O <sub>3</sub> Quartz		
Lead Bromide	PbBr <sub>2</sub>	373	6.680	8.830	1.000			Toxic.
Lead Chloride	PbCl <sub>2</sub>	501	5.850	8.830	1.000	Al <sub>2</sub> O <sub>3</sub>		Toxic. Little Decomposition.
Lead Fluoride	PbF <sub>2</sub>	855	8.240	8.830	1.000	BeO		Toxic, sublimes. Z.Physic 159,117 (1959).
Lead Iodide	PbI <sub>2</sub>	502	6.160	8.830	1.000	Quartz		Toxic. J. Opt. Soc. 65,914.
Lead Oxide	PbO	888	9.530	8.830	1.000	Quartz, Al <sub>2</sub> O <sub>3</sub>		Toxic. No decomposition. J. Opt. Soc. Am. 52,161 (1962)
Lead Selenide	PbSe	1065	8.100	8.830	1.000	Graphite, Al <sub>2</sub> O <sub>3</sub>		Toxic, sublimes.
Lead Stannate	PbSnO <sub>3</sub>	1115	8.100	8.830	1.000	Al <sub>2</sub> O <sub>3</sub>		Toxic. Disproportionates.
Lead Sulfide	PbS	1114	7.500	15.600	0.566			Toxic, sublimes. Little decomposition.
Lead Telluride	PbTe	917	8.160	8.830	1.000	Graphite, Al <sub>2</sub> O <sub>3</sub>		Vapors toxic. Deposits te rich. Sputter or coevaporate.
Lead Titanate	PbTiO <sub>3</sub>		7.520	8.830	1.000			Toxic.
Lithium	Li	180	0.530	1.500	5.887	Al <sub>2</sub> O <sub>3</sub>	medium	Metal reacts rapidly in air.
Lithium Bromide	LiBr	550	3.460	8.830	1.000			
Lithium Chloride	LiCl	614	2.070	8.830	1.000			Use gentle preheat to outgas.
Lithium Fluoride	LiF	841	2.640	11.410	0.774	Al <sub>2</sub> O <sub>3</sub>		Rate control important. Use preheat to Outgas. App. Opt. 11,2245 (1972).
Lithium Iodide	LiI	450	3.490	8.830	1.000			
Lithium Oxide	Li <sub>2</sub> O	1427	2.010	8.830	1.000			
Lutetium	Lu	1652	9.840	18.396	0.480	Al <sub>2</sub> O <sub>3</sub>		Ta impurity a problem.
Lutetium Oxide	Lu <sub>2</sub> O <sub>3</sub>	2487	9.410	8.830	1.000			Decomposes.



Magnesium	Mg	650	1.740	5.480	1.611	Al <sub>2</sub> O <sub>3</sub> , Vitreous carbon	large	Flammable, sublimes. Extremely high rates possible.
Magnesium Aluminate	MgAl <sub>2</sub> O <sub>4</sub>	2135	3.600	8.830	1.000			Natural spinel.
Magnesium Bromide	MgBr <sub>2</sub>	700	3.720	8.830	1.000			Decomposes.
Magnesium Chloride	MgCl <sub>2</sub>	714	2.320	8.830	1.000			Decomposes.
Magnesium Fluoride	MgF <sub>2</sub>	1248	3.000	13.860	0.637	Graphite, Re-infiltrated, Mo	medium	Substrate heat required for optical films.
Magnesium Iodide	MgI <sub>2</sub>	700	4.240	8.830	1.000			
Magnesium Oxide	MgO	2800	3.580	21.480	0.411	Re-infiltrated, Graphite, Al <sub>2</sub> O <sub>3</sub>	large	W produces volatile oxides. App. Opt. 11, 2243 (1972).
Manganese	Mn	1241	7.200	23.420	0.377	Al <sub>2</sub> O <sub>3</sub>		Flammable, sublimes.
Manganese (II) Sulfide	MnS	3.58	3.990	9.390	0.940			
Manganese Bromide	MnBr <sub>2</sub>	695	4.380	8.830	1.000			
Manganese Chloride	MnCl <sub>2</sub>	650	2.980	8.830	1.000			
Manganese Oxide	Mn <sub>3</sub> O <sub>4</sub>	1705	4.860	8.830	1.000			
Mercury Sulfide	HgS	583	8.100	8.830	1.000	Al <sub>2</sub> O <sub>3</sub>		Toxic, decomposes.
Mercury	Hg	-39	13.460	11.930	0.740			Toxic.
Molybdenum	Mo	2610	10.200	34.360	0.257	Re-infiltrated	medium to large	Careful degas required
Molybdenum Boride	Mo <sub>2</sub> B <sub>3</sub>	2200	7.480	8.830	1.000			
Molybdenum Carbide	Mo <sub>2</sub> C	2687	9.180	8.830	1.000			Evaporation of Mo (CO) <sub>6</sub> yields Mo <sub>6</sub> C.
Molybdenum Oxide	MoO <sub>3</sub>	795	4.690	8.830	1.000	Al <sub>2</sub> O <sub>3</sub> , BN		
Molybdenum Silicide	MoSi <sub>2</sub>	2050	6.310	8.830	1.000			Slight O <sub>2</sub> loss.
Molybdenum Sulfide	MoS <sub>2</sub>	1185	4.800	8.830	1.000			Decomposes.
Neodymium	Nd	1024	7.000	10.510	0.840	Al <sub>2</sub> O <sub>3</sub>		Flammable.
Neodymium Fluoride	NdF <sub>3</sub>	1410	6.510	8.830	1.000	Al <sub>2</sub> O <sub>3</sub>		Very little decomposition.
Neodymium Oxide	Nd <sub>2</sub> O <sub>3</sub>	1900	7.240	8.830	1.000	ThO <sub>2</sub>		Loses O <sub>2</sub> , films clear, EB preferred. Hygroscopic. N varies with substrate temp.
Nichrome IV	Ni/Cr	1395	8.500	26.760	0.330	Re-infiltrated, Graphite, Al <sub>2</sub> O <sub>3</sub>	medium	Alloys with refractory metals.
Nickel	Ni	1453	8.910	26.680	0.331	Re-infiltrated, Graphite, Al <sub>2</sub> O <sub>3</sub>	medium	Alloys with refractory metals.

Nickel Bromide	NiBr <sub>2</sub>	963	4.640	8.830	1.000			Sublimes.
Nickel Chloride	NiCl <sub>2</sub>	1001	3.550	8.830	1.000			Sublimes.
Nickel Oxide	NiO	1990	6.690	8.830	1.000	Al <sub>2</sub> O <sub>3</sub>		Dissociates upon heating.
Niobium	Nb	2468	8.570	17.910	0.493			Attacks W Source.
Niobium Boride	NbB <sub>2</sub>	3050	6.970	8.830	1.000			
Niobium Carbide	NbC	3608	7.820	8.830	1.000			
Niobium Nitride	NbN	2573	8.400	8.830	1.000			Reactive, evaporate Nb in 10 <sup>3</sup> N <sub>2</sub> .
Niobium Oxide (V)	Nb <sub>2</sub> O <sub>5</sub>	1520	4.470	8.830	1.000			
Niobium Telluride	NbTe <sub>5</sub>		7.600	8.830	1.000			Composition variable.
Osmium	Os	3045	22.600	67.923	0.130			Toxic.
Palladium	Pd	1552	12.000	24.730	0.357	Re-infiltrated, Al <sub>2</sub> O <sub>3</sub>	medium	Alloys with refractory metals. Spits in EB.
Palladium Oxide	PdO	870	8.700	8.830	1.000	Al <sub>2</sub> O <sub>3</sub>		Decomposes.
Permalloy	Ni/Fe	1395	8.700	8.830	1.000	Al <sub>2</sub> O <sub>3</sub> , Vitreous carbon	medium	Films low in Ni content. Use 84% Ni source. JVST 7 (6), 573 (1970).
Phosphorus	P	44.2	1.820	8.830	1.000	Al <sub>2</sub> O <sub>3</sub>		Metal reacts violently in air.
Platinum	Pt	1769	21.400	36.040	0.245	Graphite, Re-infiltrated	medium	Alloys, EB Req'd. Films soft. Poor adhesion.
Platinum Oxide	PtO <sub>2</sub>	450	10.200	8.830	1.000			
Plutonium	Pu	635	19.000	8.830	1.000			Toxic, radioactive.
Polonium	Po	254	9.400	8.830	1.000	Quartz		Radioactive.
Potassium	K	64	0.860	8.830	1.000	Quartz		Metal reacts violently in air. Use gentle preheat to outgas.
Potassium Bromide	KBr	731	2.790	8.830	1.000	Quartz		Use gentle preheat to outgas.
Potassium Chloride	KCl	770	1.980	4.310	2.049			Melt in air to outgas.
Potassium Fluoride	KF	846	2.480	8.830	1.000	Quartz		Melt in air to outgas.
Potassium Hydroxide	KOH	360	2.040	8.830	1.000			Melt in air to outgas. Hygroscopic.
Potassium Iodide	KI	686	3.130	4.415	2.000			Melt in air to outgas.
Praseodymium	Pr	936	6.770	8.830	1.000			Flammable.
Praseodymium Chloride	PrCl <sub>3</sub>	786	4.020	8.830	1.000			

Praseodymium Oxide	Pr <sub>2</sub> O <sub>3</sub>	2125	6.880	8.830	1.000	ThO <sub>2</sub>		Loses Oxygen.
Radium	Ra	700	5.000	8.830	1.000			
Rhenium	Re	3180	21.040	58.870	0.150			
Rhenium Oxide	Re <sub>2</sub> O <sub>7</sub>	297	6.100	8.830	1.000			
Rhodium	Rh	1966	12.410	42.050	0.210		medium	
Rubidium	Rb	38	1.530	3.476	2.540	Quartz		
Rubidium Chloride	RbCl	715	2.800	8.830	1.000	Quartz		
Rubidium Iodide	RbI	641	3.590	8.830	1.000	Quartz		
Ruthenium	Ru	2500	12.450	44.150	0.200			Spits violently in EB. Requires long degas.
Samarium	Sm	1072	7.540	9.920	0.890	Al <sub>2</sub> O <sub>3</sub>		
Samarium Oxide	Sm <sub>2</sub> O <sub>3</sub>	2350	8.350	8.830	1.000	ThO <sub>2</sub>		Loses O <sub>2</sub> . Films smooth, clear.
Samarium Sulfide	Sm <sub>2</sub> S <sub>3</sub>	1900	5.720	8.830	1.000			A. IP Conf. Proc. On Mag. & Mag. Mat. B, 5,860 (1971)
Scandium	Sc	1539	3.000	9.700	0.910	Al <sub>2</sub> O <sub>3</sub> BeO		Alloys with Ta. Flammable.
Scandium Fluoride	ScF <sub>3</sub>	1550	2.500	8.830	1.000			
Scandium Oxide	Sc <sub>2</sub> O <sub>3</sub>	2300	3.860	8.830	1.000			Loses O <sub>2</sub> .
Selenium	Se	217	4.820	10.220	0.864	Al <sub>2</sub> O <sub>3</sub> Vit Carbon		Very toxic. Poisons vacuum systems. JVST 9, 387 (1972) JVST 12, 573 & 807 (1975).
Silicon	Si	1410	2.320	12.400	0.712	BeO Ta Vit Carbon		Alloys with W; Some SiO produced above 4x10 <sup>6</sup> Torr. App. Opt. 15,2348 (1976).
Silicon (II) Oxide	SiO	1702	2.130	10.150	0.870			
Silicon Boride	SiB <sub>4</sub>	1870	2.470	8.830	1.000			
Silicon Carbide	SiC	2700	3.220	8.830	1.000			Sputtering Preferred.
Silicon Dioxide	SiO <sub>2</sub>	1713	2.200	8.250	1.070	Graphite, Re-infiltrated, Mo	large	Quartz xlnt. in EB.
Silicon Monoxide	SiO	1702	2.100	17.660	0.500	Graphite, Re-infiltrated, Mo	large	Sublimes.
Silicon Nitride	Si <sub>3</sub> N <sub>4</sub>	1900	3.440	8.830	1.000			Sublimes.
Silicon Sulfide	SiS		1.850	8.830	1.000	Quartz		
Silicon Telluride	SiTe <sub>2</sub>		4.390	8.830	1.000	Quartz		Toxic.

Silver	Ag	961	10.500	16.690	0.529	Graphite, Re-infiltrated, Mo	none or small	Evaporates well from any source.
Silver Bromide	AgBr	431	6.470	7.480	1.180	Quartz		
Silver Chloride	AgCl	455	5.560	6.690	1.320	Quartz		
Silver Iodide	AgI	558	6.010	8.830	1.000			
Sodium	Na	97	0.970	1.840	4.799			Metal reacts violently in air.
Sodium Bromide	NaBr	755	3.200	8.830	1.000	Quartz		Use gentle preheat to outgas.
Sodium Chloride	NaCl	801	2.170	5.620	1.571	Quartz		Little decomposition. Use gentle preheat to outgas. Hydrscopic.
Sodium Cyanide	NaCN	563	1.595	8.830	1.000			Toxic. Use gentle preheat to outgas.
Sodium Fluoride	NaF	988	2.560	8.830	1.000	BeO		Use gentle preheat to outgas.
Sodium Hydroxide	NaOH	318	2.130	8.830	1.000			Melt in air to outgas. Deliquescent.
Sodium Iodide	NaI	651	3.670	8.830	1.000			
Strontium	Sr	769	2.620	8.830	1.000	Vit Carbon		Toxic. Wets but does not alloy with refractory metal May react violently in air.
Strontium Fluoride	SrF <sub>2</sub>	1450	4.240	8.830	1.000	Al <sub>2</sub> O <sub>3</sub>		
Strontium Oxide	SrO	2461	4.900	8.830	1.000	Al <sub>2</sub> O <sub>3</sub>		Sublimes. Reacts with Mo and W.
Strontium Sulfide	SrS	2002	3.700	8.830	1.000			Decomposes.
Sulphur	S	115	2.070	3.860	2.288			Toxic. Poisons vacuum system.
Tantalum	Ta	2996	16.600	33.700	0.262	Re-infiltrated	medium	Forms good films.
Tantalum Boride	TaB <sub>2</sub>	3000	11.150	8.830	1.000			
Tantalum Carbide	TaC	3880	14.650	8.830	1.000			JVST 12, 811 (1975).
Tantalum Nitride	TaN	3360	16.300	8.830	1.000			Reactive; evaporate Ta in 10 <sup>3</sup> N <sub>2</sub> .
Tantalum Pentoxide	Ta <sub>2</sub> O <sub>5</sub>	1872	8.200	29.430	0.300	Graphite, Re-infiltrated, Mo	large	
Tantalum Sulfide	TaS <sub>2</sub>	3000	6.860	8.830	1.000			
Technetium	Tc	2200	11.500	8.830	1.000			
Tellurium	Te	452	6.250	9.810	0.900	Al <sub>2</sub> O <sub>3</sub> Quartz		Toxic. Wets w/o alloying.
Terbium	Tb	1357	8.270	13.380	0.660	Al <sub>2</sub> O <sub>3</sub>		
Terbium Oxide	Tb <sub>2</sub> O <sub>3</sub>	2387	7.870	8.830	1.000			Partially decomposes.
Thallium	Tl		11.850	5.700	1.549			

Thallium Bromide	TiBr	480	7.560	4.989	1.770	Quartz		Toxic, sublimes.
Thallium Chloride	TiCl	430	7.000	7.298	1.210	Quartz		Toxic, sublimes.
Thallium Iodide (B)	TII	440	7.090	8.830	1.000	Quartz		Toxic, sublimes.
Thallium Oxide	Tl <sub>2</sub> O <sub>3</sub>	717	9.650	8.830	1.000			Toxic. Goes to Tl <sub>2</sub> at 850°C.
Thorium	Th	1875	11.700	16.352	0.540			Toxic, radioactive.
Thorium Bromide	ThBr <sub>4</sub>		5.670	8.830	1.000			Radioactive, sublimes.
Thorium Carbide	ThC <sub>2</sub>	2776	8.960	8.830	1.000	Carbon		Radioactive.
Thorium Fluoride	ThF <sub>4</sub>	900	6.320	11.932	0.740	Vit Carbon		Radioactive. Heat substrate to above 150°C. JVST 12,919 (1975).
Thorium Oxide	ThO <sub>2</sub>	3050	9.860	8.830	1.000			Radioactive.
Thorium Oxyfluoride	ThOF <sub>2</sub>	900	9.100	8.830	1.000			Radioactive. Films often ThF <sub>4</sub> .
Thulium	Tm	1545	9.320	16.981	0.520	Al <sub>2</sub> O <sub>3</sub>		Sublimes.
Thulium Oxide	Tm <sub>2</sub> O <sub>3</sub>		8.900	8.830	1.000			Decomposes.
Tin	Sn	232	7.300	12.200	0.724	Re-infiltrated	none	Wets Mo; use Ta liner in EB guns.
Tin Oxide	SnO <sub>2</sub>	1131	6.990	8.830	1.000	Al <sub>2</sub> O <sub>3</sub>	large	Films from W oxygen deficient oxidize in air.
Tin Selenide	SnSe	861	6.180	8.830	1.000	Quartz		JVST 12, 110 (1975).
Tin Sulfide	SnS	882	5.220	8.830	1.000	Quartz		
Tin Telluride	SnTe	780	6.440	8.830	1.000	Quartz		
Titanium	Ti	1668	4.500	14.060	0.628	Re-infiltrated		Alloys with refractory metals; evolves gas on first heating.
Titanium Boride	TiB <sub>2</sub>	2900	4.500	8.830	1.000			
Titanium Carbide	TiC	3140	4.930	8.830	1.000			JVST 12, 851 (1975).
Titanium Dioxide (rutile)	TiO <sub>2</sub>	1843	4.260	22.070	0.400	Graphite, Re-infiltrated, Mo	large	
Titanium Monoxide	TiO	1750	4.930	8.830	1.000	Graphite, Re-infiltrated, Mo	large	
Titanium Silicide	TiSi <sub>2</sub>	1540	4.390	8.830	1.000			
Tungsten	W	3387	19.300	54.170	0.163		medium to large	Forms volatile oxides. Films hard and adherent.
Tungsten Boride	WB <sub>2</sub>	2900	12.750	8.830	1.000			
Tungsten Carbide	WC	2785	15.600	58.480	0.151			
Tungsten Oxide	WO <sub>3</sub>	1473	7.160	8.830	1.000			Sublimes Preheat to outgas. W reduces oxide

								slightly. App. OPT 28, 1497.
Tungsten Selenide	WSe <sub>2</sub>	2150	9.000	8.830	1.000			
Tungsten Silicide	WSi <sub>2</sub>	2165	9.400	8.830	1.000			
Tungsten Sulfide	WS <sub>2</sub>	1250	7.510	8.830	1.000			
Tungsten Telluride	WTe <sub>3</sub>		9.490	8.830	1.000	Quartz		
Uranium	U	1132	18.700	37.100	0.238			Films oxidize.
Uranium (IV) Oxide	UO <sub>2</sub>	2500	10.900	8.830	1.000			Ta causes decomposition.
Uranium Carbide	UC <sub>2</sub>	2260	11.280	8.830	1.000	Carbon		Decomposes.
Uranium Oxide	U <sub>3</sub> O <sub>3</sub>		8.300	8.830	1.000			Decomposes at 1300°C to UO <sub>2</sub> .
Uranium Phosphide	UP <sub>2</sub>		8.570	8.830	1.000			Decomposes.
Uranium Tetrafluoride	UF <sub>4</sub>	1036	6.700	8.830	1.000			
Vanadium	V	1890	5.960	16.660	0.530			Wets Mo. EB evaporated films preferred.
Vanadium (IV) Oxide	VO <sub>2</sub>	1967	4.340	8.830	1.000			Sublimes. Deposit V metal @ 7x10 <sup>3</sup> O <sub>2</sub> JVST A2(2), 301 (1984) & A7 (3), 1310 (1989).
Vanadium (V) Oxide	V <sub>2</sub> O <sub>5</sub>	690	3.360	8.830	1.000	Quartz		
Vanadium Boride	VB <sub>2</sub>	2400	5.100	8.830	1.000			
Vanadium Carbide	VC	2810	5.770	8.830	1.000			
Vanadium Nitride	VN	2320	6.130	8.830	1.000			
Vanadium Silicide	VSi <sub>2</sub>	1700	4.420	8.830	1.000			
Ytterbium	Yb	824	6.980	7.810	1.131			Sublimes.
Ytterbium Fluoride	YbF <sub>3</sub>	1161	8.190	8.830	1.000			
Ytterbium Oxide	Yb <sub>2</sub> O <sub>3</sub>	2227	9.170	8.830	1.000			Sublimes. Loses oxygen.
Yttrium	Y	1509	4.340	10.570	0.835	Al <sub>2</sub> O <sub>3</sub>	medium	High Ta solubility.
Yttrium Fluoride	YF <sub>3</sub>	1152	4.010	8.830	1.000			
Yttrium Oxide	Y <sub>2</sub> O <sub>3</sub>	2410	5.010	8.830	1.000	C		Sublimes. Loses oxygen, films smooth and clear.
Zinc	Zn	419	7.040	17.180	0.514	Mo		Evaporates well under wide range of conditions. Use Mo E.B. Liner.
Zinc Antimonide	Zn <sub>3</sub> Sb <sub>2</sub>	570	6.330	8.830	1.000			

Zinc Bromide	ZnBr <sub>2</sub>	391	4.990	8.830	1.000	Carbon		Decomposes.
Zinc Fluoride	ZnF <sub>2</sub>	872	4.950	8.830	1.000	Quartz		
Zinc Nitride	Zn <sub>3</sub> N <sub>2</sub>		6.220	8.830	1.000			Decomposes.
Zinc Oxide	ZnO	1975	5.610	15.880	0.556		large	Anneal in air at 450°C to reoxidize.
Zinc Selenide	ZnSe	1526	5.260	12.230	0.722	Quartz		Toxic. Use gentle preheat to outgas. Sublimes well. Z. Angew. Phys. 19,392 (1965).
Zinc Sulfide	ZnS	1700	4.090	11.390	0.775			Sublimes. Gentle preheat req'd. Sticking coeff varies with sub temp. JVST 6,433 (1969).
Zinc Telluride	ZnTe	1240	6.340	8.830	1.000			Toxic. Sublimes. Use gentle preheat to outgas.
Zircon	ZrSiO <sub>4</sub>	2550	4.560	8.830	1.000			
Zirconium	Zr	2128	6.510	14.720	0.600		medium	Flammable. Films oxidize readily.
Zirconium Bromide	ZrB <sub>2</sub>	3000	6.090	8.830	1.000			
Zirconium Carbide	ZrC	3540	6.730	8.830	1.000			
Zirconium Nitride	ZrN	2980	7.090	8.830	1.000			Reactively evaporate in 10 <sup>3</sup> N <sub>2</sub> atmosphere.
Zirconium Oxide	ZrO <sub>2</sub>	2715	5.490	8.830	1.000		large	Films oxygen deficient, clear and hard.
Zirconium Silicide	ZrSi <sub>2</sub>	1790	4.880	8.830	1.000			

## 15 MAINTENANCE AND SERVICE

---

### 15.1 MAINTENANCE

---

The 861 does not require any special maintenance.

### 15.2 CLEANING

---

For cleaning the outside of the device, a slightly moistened cloth will usually do. Do not use any aggressive or abrasive cleaning agents.



Mains voltage.

Components inside of the 861 controller are components to mains voltage.

Protect the device from liquids.

Do not open the device.



## 16 STORAGE AND DISPOSAL

---

### 16.1 PACKAGING

---

Please keep the original packaging. The packaging is required for storing the 861 and for shipping it to a Telemark service center.

### 16.2 STORAGE

---

The 861 may only be stored in a dry room. The following requirements must be met:

Ambient temperature: -20...+60 °C

Humidity: as low as possible. Preferably in an air-tight plastic bag with a desiccant.

### 16.3 DISPOSAL

---

The product must be disposed of in accordance with the relevant local regulations for the environmentally safe disposal of systems and electronic components.

### 16.4 WEEE

---

The use of the Waste Electrical and Electronic Equipment (WEEE) symbol (see Figure 16-1) indicates that this product may not be treated as household waste. By ensuring this product is disposed of correctly you will protect the environment. Recycling information of this product can be obtained at the place of sale, your household waste disposal service provider, or local authority.



Figure 16-1, WEEE Symbol

## 17 WARRANTY CONDITIONS

---

### 17.1 LIMITED WARRANTY

---

The Electron Beam Source 861 is guaranteed against faulty materials, function and workmanship for a period of 12 months after delivery from Telemark. Components which are purchased by Telemark from other manufacturers will be guaranteed for any lesser time that such manufacturer warrants its products to Telemark. This warranty is valid only for normal use where regular maintenance is performed as instructed. This warranty shall not apply if repair has been performed or an alteration made by anyone other than an authorized Telemark representative or if a malfunction occurs through abuse, misuse, negligence or accident. No charge will be made for repairs made under warranty at Telemark's facilities. Freight costs both ways will be at customer's expense. Telemark reserves the right for final warranty adjustment.